

Leica DISTO™ D510

The original laser distance meter



PEWA
Messtechnik GmbH

Weidenweg 21
58239 Schwerte

Tel.: 02304-96109-0
Fax: 02304-96109-88
E-Mail: info@pewa.de
Homepage: www.pewa.de

- when it has to be **right**

Leica
Geosystems

Instrument Set-up	2
Introduction	2
Overview	2
Basic measuring screen	3
Selection screen	3
Pointfinder (Viewscreen)	4
Insert batteries	4
Operations	5
Switching ON/OFF	5
Clear	5
Message Codes	5
Multifunctional endpiece	5
Permanent / Minimum-Maximum measuring	5
Add / Subtract	6
Pointfinder (Viewscreen)	6
Settings	7
Overview	7
Tilt units	7
Distance units	8
Beep ON/OFF	8
Digital level ON/OFF	8
De-/Activate keypad lock	9
Unlock keypad	9
Personalized favorites	9
Illumination	9
De-/Activate Bluetooth Smart	10
Calibration of tilt sensor (Tilt Calibration)	11
Reset	12
Offset	12
Functions	13
Overview	13
Timer	13
Calculator	13
Adjusting measuring reference/tripod	14

Memory	14
Measuring single distance	15
Smart Horizontal Mode	15
Height-profile measurement	16
Area	17
Volume	18
Triangular area	19
Long range mode	19
Inclination tracking	20
Sloped objects	20
Height tracking	21
Trapezium	22
Stake out	23
Pythagoras (2-point)	24
Pythagoras (3-point)	25

Technical Data	26
-----------------------------	-----------

Message Codes	27
----------------------------	-----------

Care	27
-------------------	-----------

Warranty	27
-----------------------	-----------

Safety Instructions	27
----------------------------------	-----------

Areas of responsibility	27
Permitted use	28
Prohibited use	28
Hazards in use	28
Limits of use	28
Disposal	28
Electromagnetic Compatibility (EMC)	29
Use of the product with Bluetooth®	29
Laser classification	29
Labelling	29

Introduction

 The safety instructions and the user manual should be read through carefully before the product is used for the first time.

 The person responsible for the product must ensure that all users understand these directions and adhere to them.

The symbols used have the following meanings:

WARNING

Indicates a potentially hazardous situation or an unintended use which, if not avoided, will result in death or serious injury.

CAUTION

Indicates a potentially hazardous situation or an unintended use which, if not avoided, may result in minor injury and/or appreciable material, financial and environmental damage.

 Important paragraphs which must be adhered to in practice as they enable the product to be used in a technically correct and efficient manner.

Overview

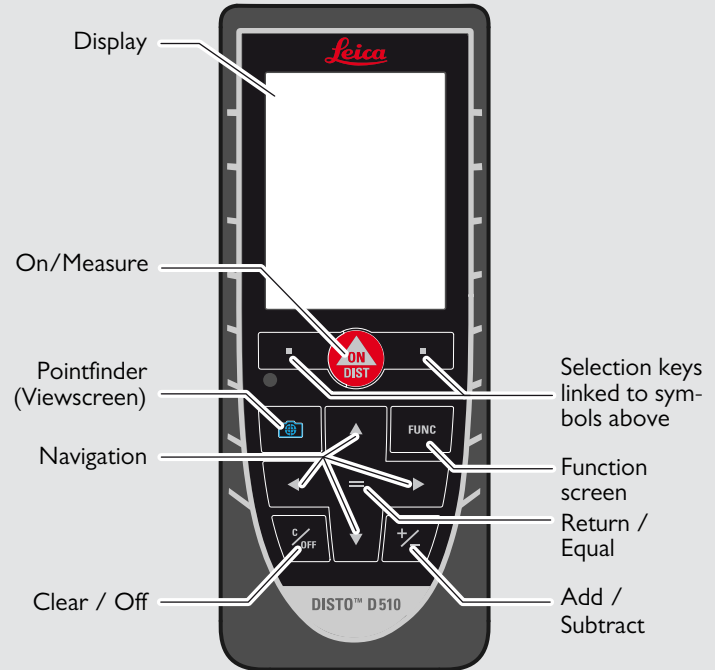

Basic measuring screen

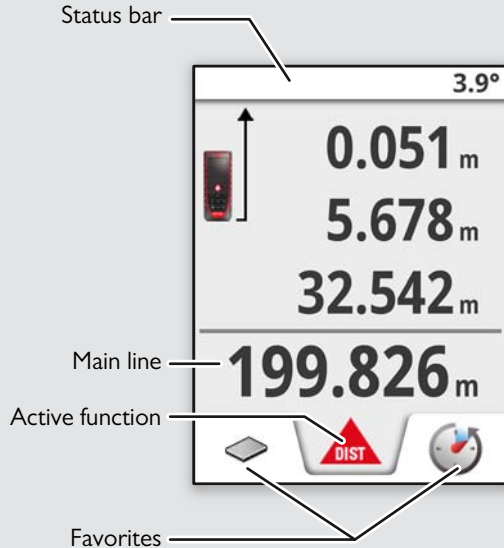

Selection screen

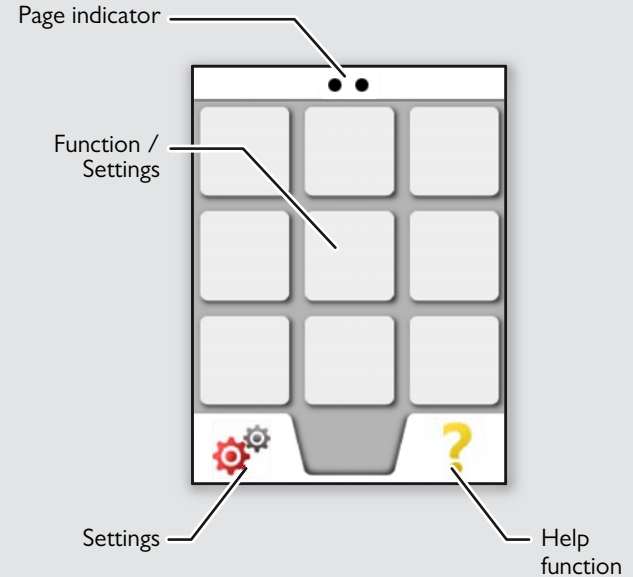

Pointfinder (Viewscreen)

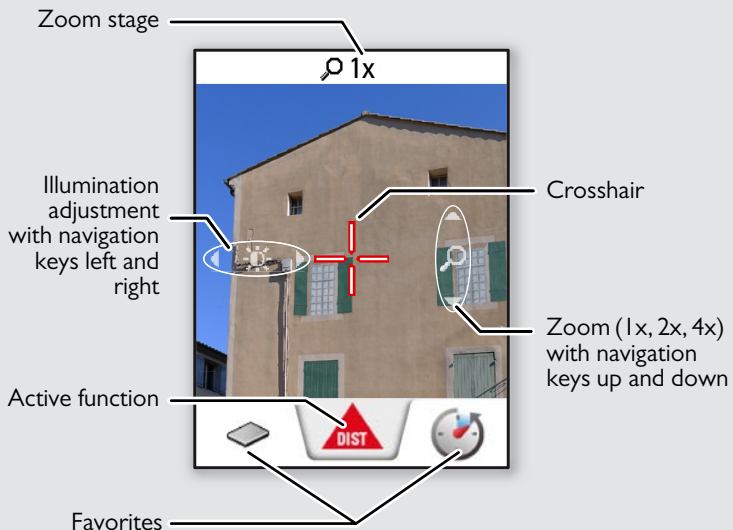

Insert batteries

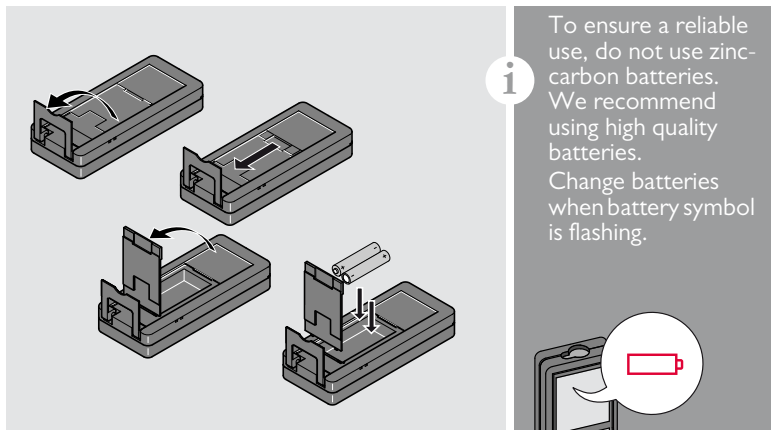

Switching ON/OFF



i Press ON button 2 sec to start continuous laser mode. If no key is pressed for 180 sec, the device switches off automatically.

Clear

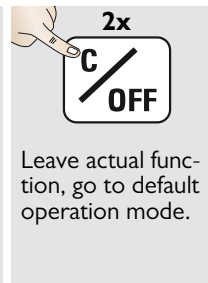
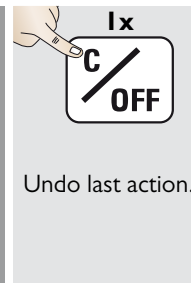

Message Codes

If the info icon appears with a number, observe the instructions in section "Message Codes". Example:



Multifunctional endpiece

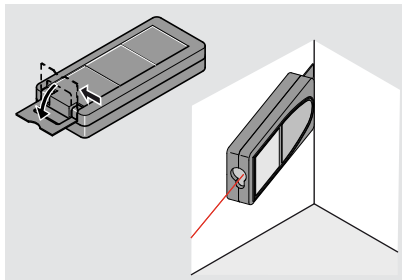
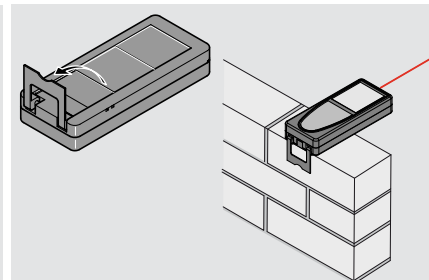

i The orientation of the endpiece is automatically detected and the zero point is accordingly adjusted.

Permanent / Minimum-Maximum measuring

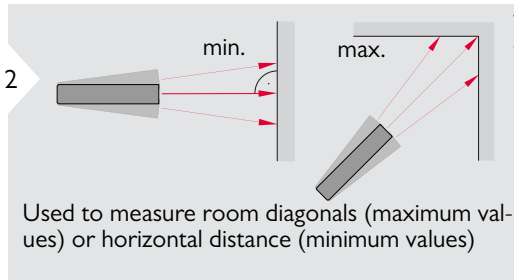

The minimum and maximum distance measured is displayed (min, max.). The last value measured is displayed in the main line.



Add / Subtract

1 **ON DIST**
7.332 m

2 **+ / -**
The next measurement is **added** to the previous one.

3 **2x**
+ / -
The next measurement is **subtracted** from the previous one.
7.332 m
12.847 m

4 **+**
=
20.179 m

i This process can be repeated as required. The same process can be used for adding or subtracting areas or volumes.

Pointfinder (Viewscreen)

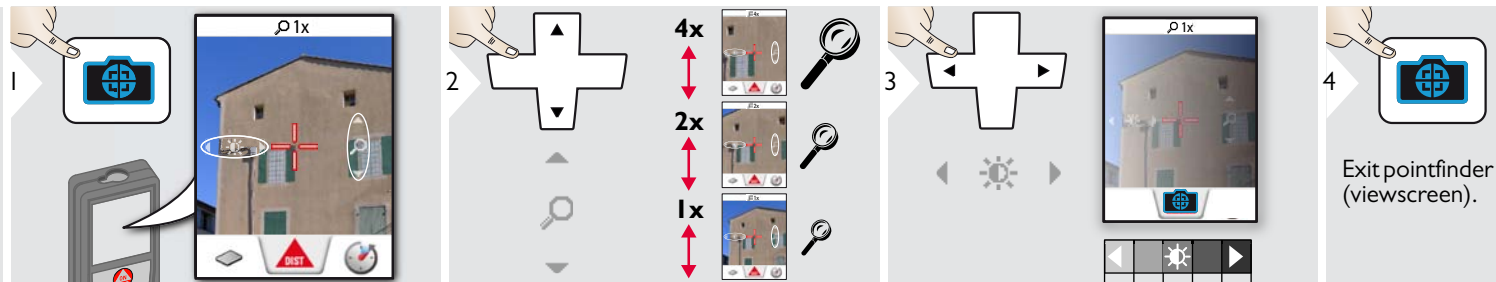

1 **Pointfinder**
Viewfinder shows target with red crosshair.

2 **+**
4x
2x
1x
Magnifying glass icons indicate zoom levels.

3 **+**
Viewfinder shows target with red crosshair.

4 **Pointfinder**
Exit pointfinder (viewscreen).

i This is a great help for outdoor measuring. The integrated pointfinder (viewscreen) shows the target on the display. The device measures in the middle of the cross hair, even if the laser dot is not visible. Parallax errors occur when the pointfinder camera is used on close targets, with the effect that the laser appears displaced in the crosshair. In this case rely on the real laser dot.

Overview

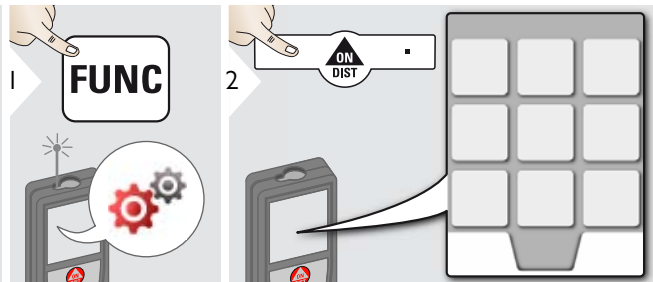

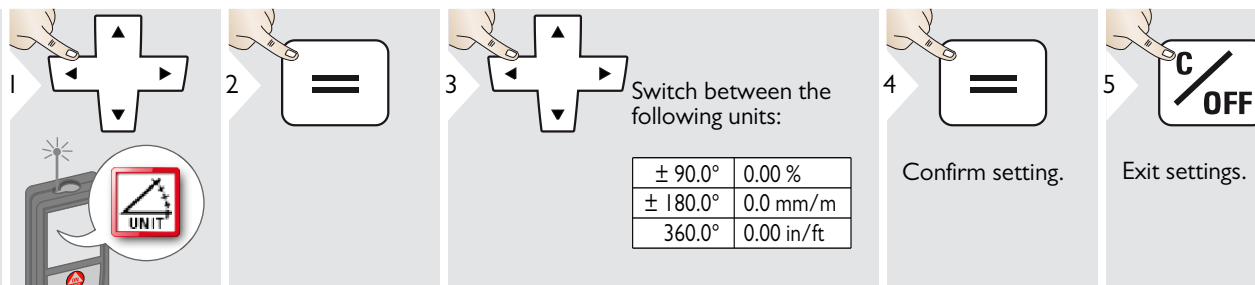

	Tilt units
	Distance units
	Beep
	Digital level
	Keypad lock
	Favorites
	Illumination
	Bluetooth®
	Tilt calibration
	Reset
	Offset

Tilt units



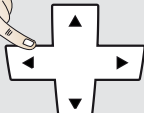

Distance units

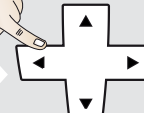
1  2 



3  Switch between the following units:

0.0000 m	0.00 ft
0.000 m	0'00" 1/32
0.00 m	0.00 in
0 mm	0 in 1/32
	0.000 yd

4  Confirm setting.

5  Exit settings.



Beep ON/OFF

1  2 

3  Exit settings.

To switch ON, repeat procedure.

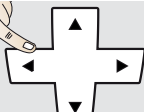
Digital level ON/OFF

1  2 



3  Exit settings.

To switch ON, repeat procedure.

i The digital level is displayed in the status line.

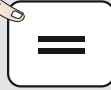

De-/Activate keypad lock

1  2  To deactivate, repeat procedure.

 OFF  ON 

Unlock keypad

3  Exit settings.

1  2  within 2 sec

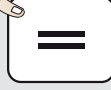
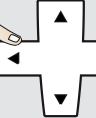

Personalized favorites

1  2  3  Select favorite function.

4  Press selection key left or right. Function is set as favorite above the corresponding selection key.

5  Exit settings.

i Select your favorite functions for quick access.

Short cut: Press 2 sec on a selection-key in the measuring mode.

Illumination

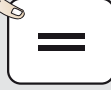
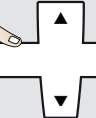
1  2  3  Select brightness.

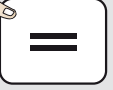
4  Confirm setting.

5  Exit settings.

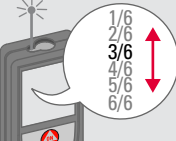

i To save power reduce brightness if not necessary.

De-/Activate Bluetooth Smart

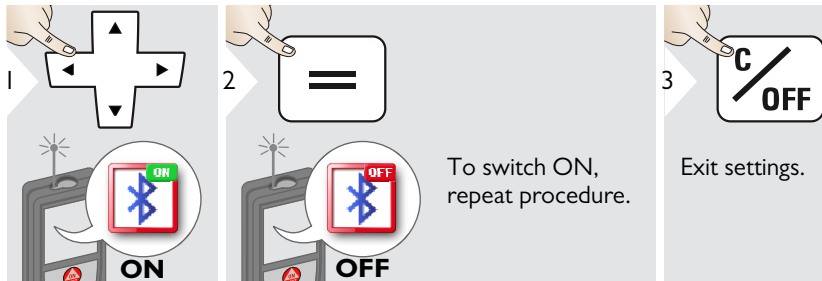

i Default mode:
Bluetooth is switched on.
Bluetooth icon in status line is displayed if device is connected with Bluetooth.

i Switch on Bluetooth Smart in Settings.
Connect the device with your smart phone, pad, laptop, ...
A blue Bluetooth symbol appears on the laser distance meter if the connection is established.
Bluetooth switches off as soon as the laser distance meter is switched off.
The efficient and innovative Bluetooth Smart module (with the new Bluetooth standard V4.0) works together with all Bluetooth Smart Ready devices. All other Bluetooth devices do not support the energy saving Bluetooth Smart Module, which is integrated in the device.

We provide no warranty for free DISTO™ software and offer no support for it. We accept no liability whatsoever arising from the use of the free software and we are not obliged to provide corrections nor to develop upgrades. A wide range of commercial software can be found on our homepage. Apps for Android® or Mac iOS can be found in special internet shops.
For more details, see our homepage.

Calibration of tilt sensor (Tilt Calibration)

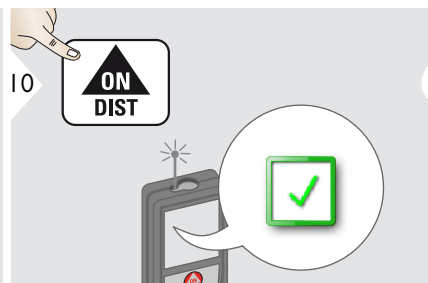
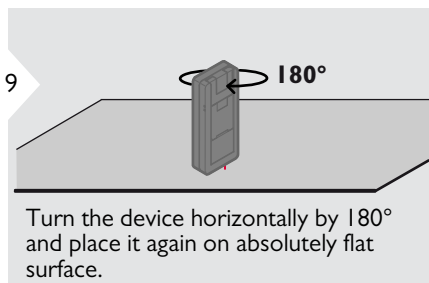
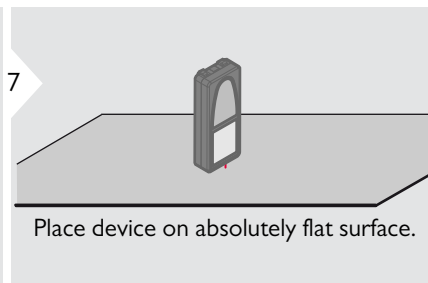
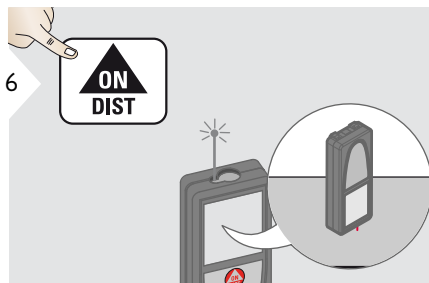
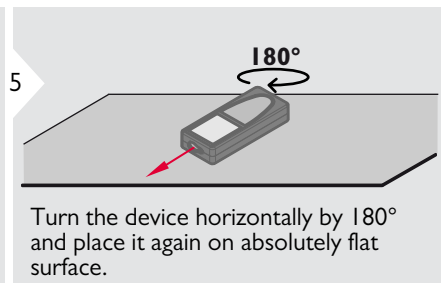
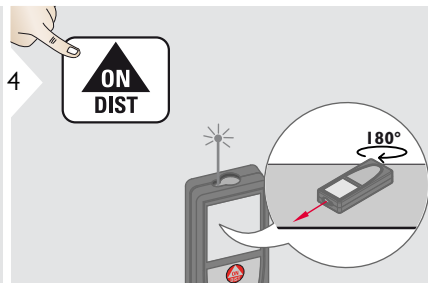
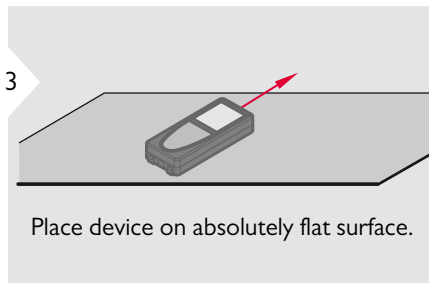
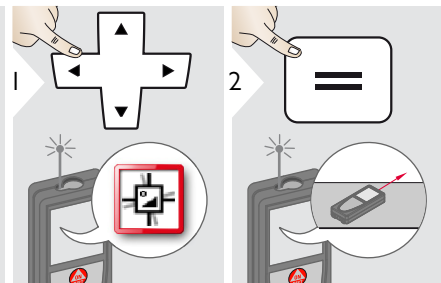

i After 2 sec the device goes back to the basic mode.

 **Reset**

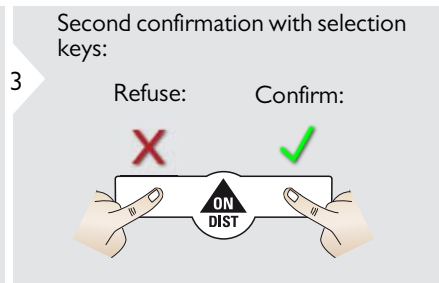
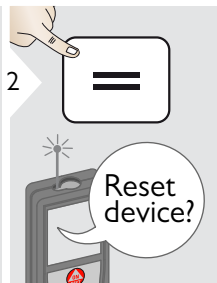
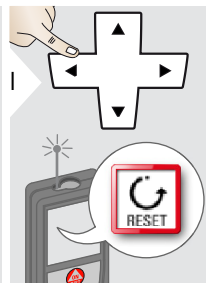

i Reset returns the instrument to the factory settings. All customized settings and memories are lost.

 **Offset**

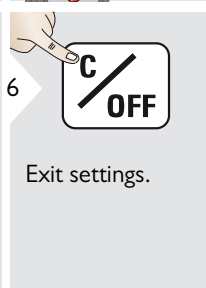
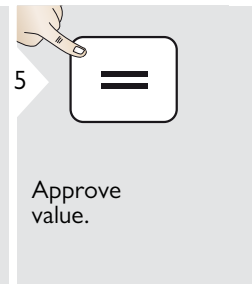
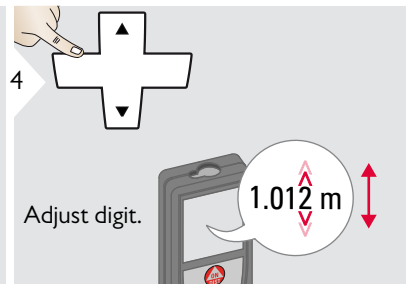
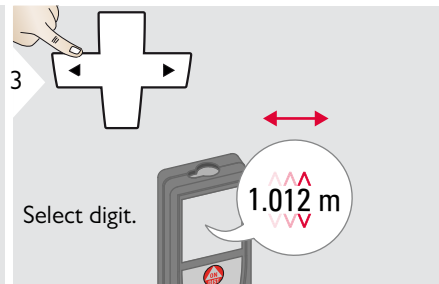
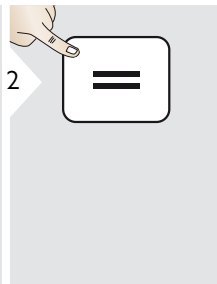
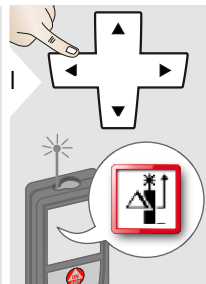

i An offset adds or subtracts a specified value automatically to or from all measurements. This function allows tolerances to be taken into account. The offset icon is displayed.

Overview

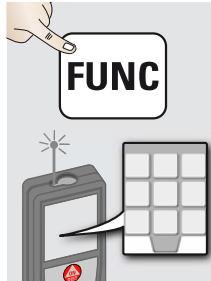

	Timer
	Calculator
	Adjusting measuring reference
	Memory
	Single Distance Measurement
	Smart Horizontal Mode

	Height-profile Measurement
	Area
	Volume
	Triangle area
	Long Range Mode
	Inclination Tracking

	Measuring on sloped objects
	Height Tracking
	Trapezium
	Stake out
	Pythagoras 1
	Pythagoras 2

Timer

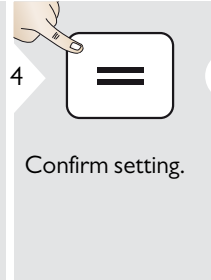
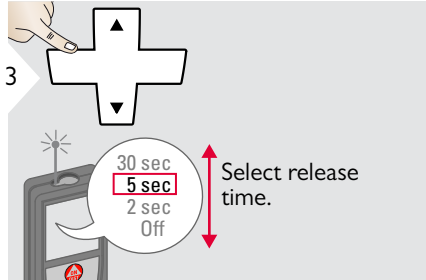
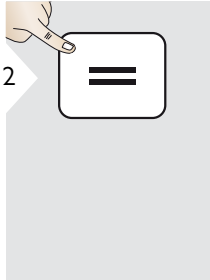
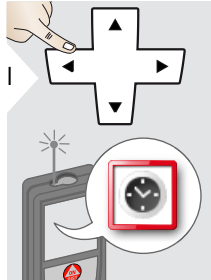

i The self release starts if ON/Measure key is pressed.

Calculator

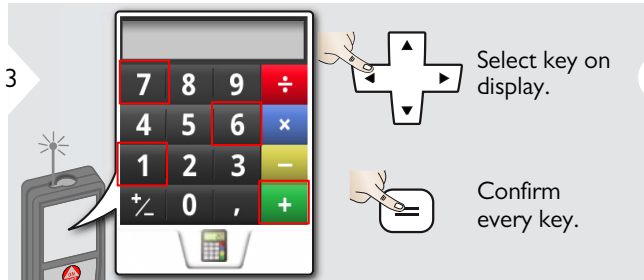
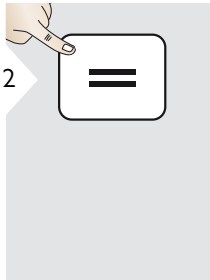
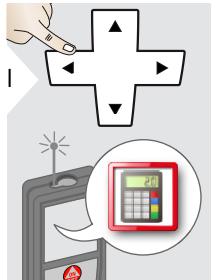

i The measurement result from the main line is taken over to the calculator and can be used for further calculations. Ft/in fractions are converted into Meters.

Adjusting measuring reference/tripod

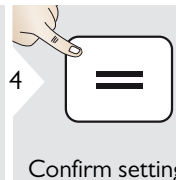
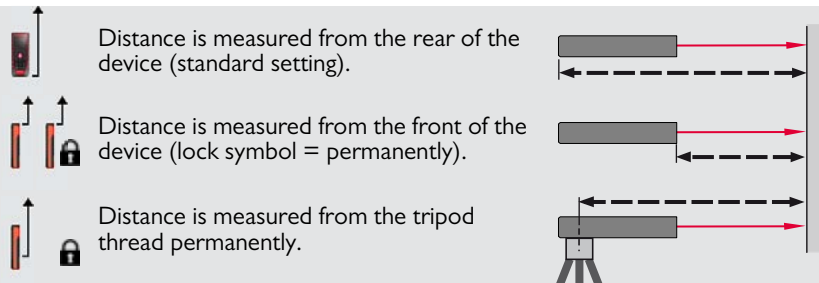
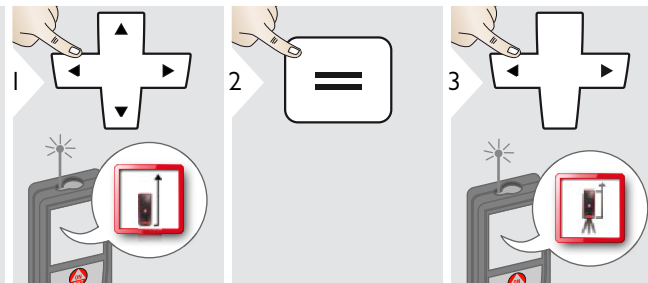

Confirm setting.

i If device is switched off, reference goes back to standard setting (rear of the device).

Memory

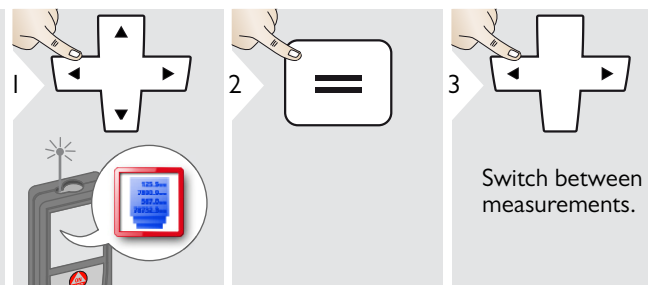

Switch between measurements.

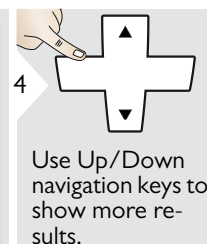
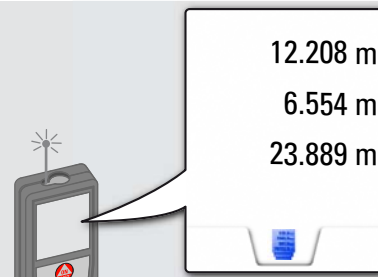

Use Up/Down navigation keys to show more results.

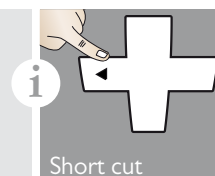

Short cut

Measuring single distance

1

2

3 Aim active laser at target.

4 **ON DIST**
8.532 m

i

Target surfaces: Measuring errors can occur when measuring to colourless liquids, glass, styrofoam or semi-permeable surfaces or when aiming at high gloss surfaces. Against dark surfaces the measuring time increases.

Smart Horizontal Mode

1

2

3 Aim laser at target.

4 **ON DIST**

	40.8°	α
	5.204 m	x
	0.032 m	y
	4.827 m	z

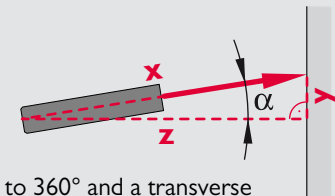

Height-profile measurement

1

2

3 Aim at reference point (REF).

4 **ON DIST**

5 Aim at additional points 1-x.

6

7 **C/OFF**

Exit function.

i Ideal for measuring of height differences to a reference point. Can be also used to measure profiles and terrain sections. After measuring the reference point, the horizontal distance and height is displayed for each following point.

d Horizontal distance to device

h Height difference to reference point (REF).

2.042 m

0.054 m

Area

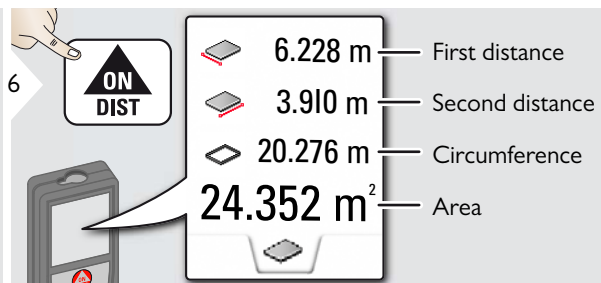
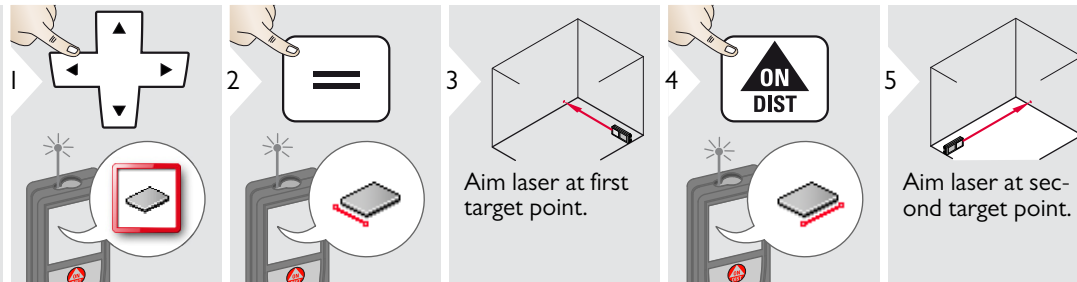

i The result is shown in the main line and the measured value above.
 Partial Measurements / Painter function:
 Press + or - after starting the first measurement. Measure and add or subtract distances. Finish with DIST. Measure 2nd length.

Volume

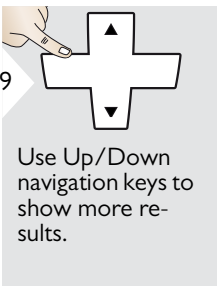
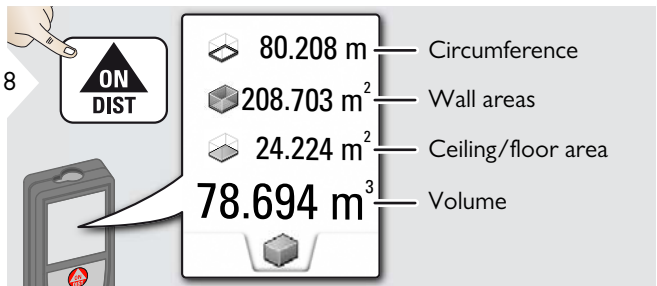
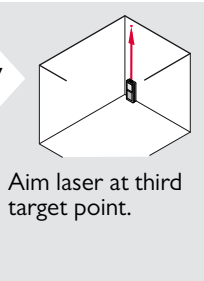
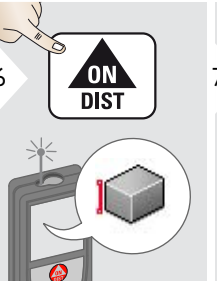
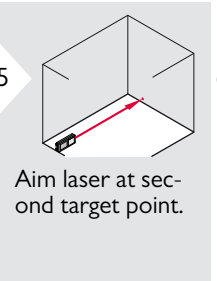
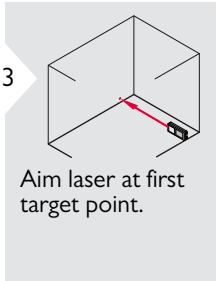
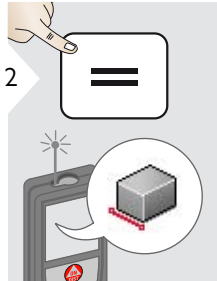
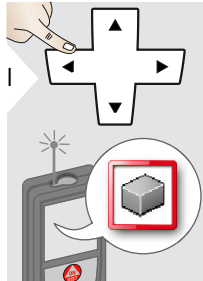

▲ Triangular area

8 **ON DIST**

▲ 23.563 m — Circumference
 ☞ 89.90° — Angle between first and second measurement
 23.813 m² — Triangular area

9

Use Up/Down navigation keys to show more results.

LR Long range mode

i The long range mode allows measuring of difficult targets in unfavorable conditions e.g. bright ambient light or bad target reflectivity. The measuring time is increased. An icon in the status line shows if the function is active.

Inclination tracking

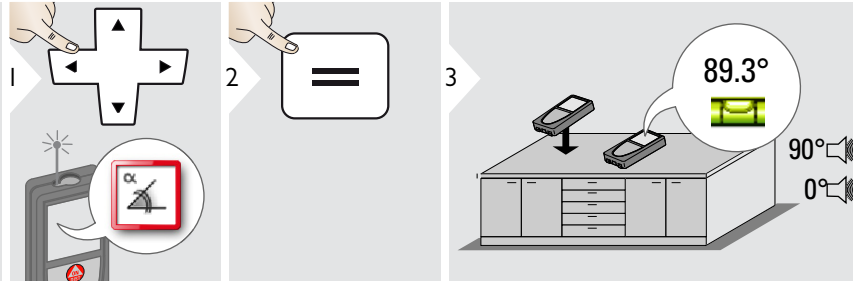

i

Inclination is permanently displayed. Instrument beeps at 0° and 90°. Ideal for horizontal or vertical adjustments.

Sloped objects

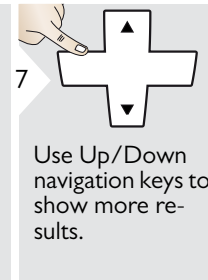
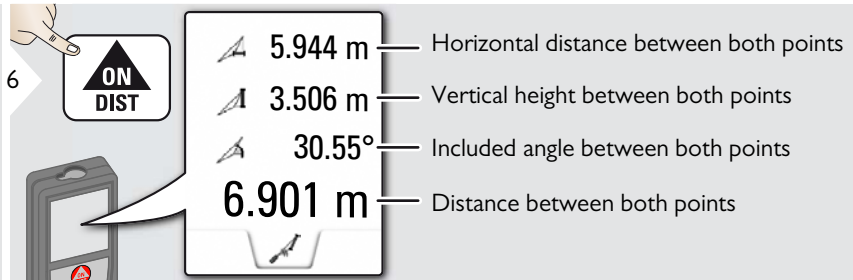
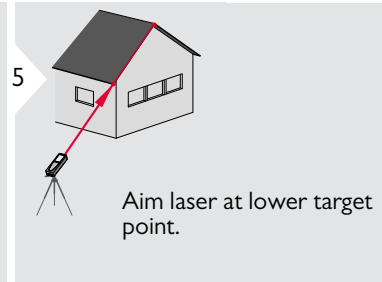
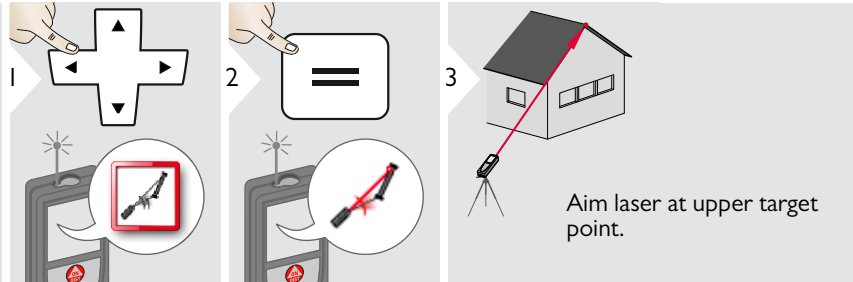

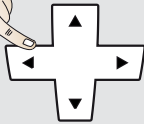
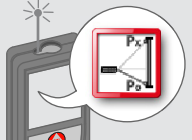

i Indirect distance measuring between 2 points with additional results. Ideal for applications such as length and slope of roof, height of chimneys, ... It is important, that the instrument is positioned in the same vertical plane as the 2 measured points. The plane is defined of the line between the 2 points.

Height tracking

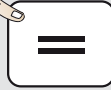

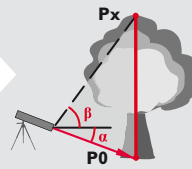
1  

2  

3  Aim laser at lower point.

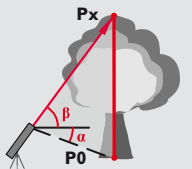
4  

5  Aim laser at upper points and angle/height tracking starts automatically.

6  

6.932 m — x
 9.827 m — y = Tracking height if device is turned on tripod

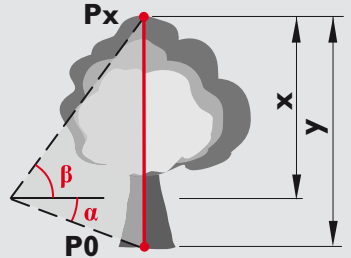

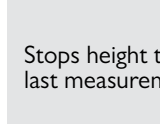
7  

Stops height tracking and displays last measurement.

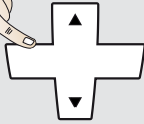
8 

Use Up/Down navigation keys to show more results.

i Heights of buildings or trees without suitable reflective points can be determined. At the bottom point, distance and tilt is measured - which needs a reflective laser target. The upper point can be targeted with the pointfinder / crosshair and does not need a reflective laser target as only the inclination is measured.

Trapezium

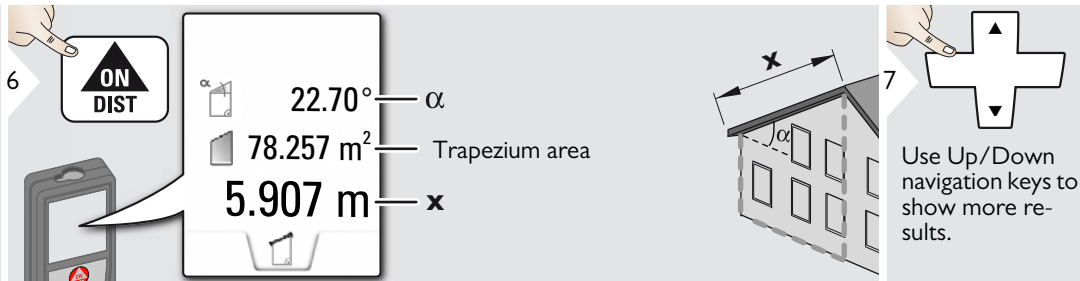
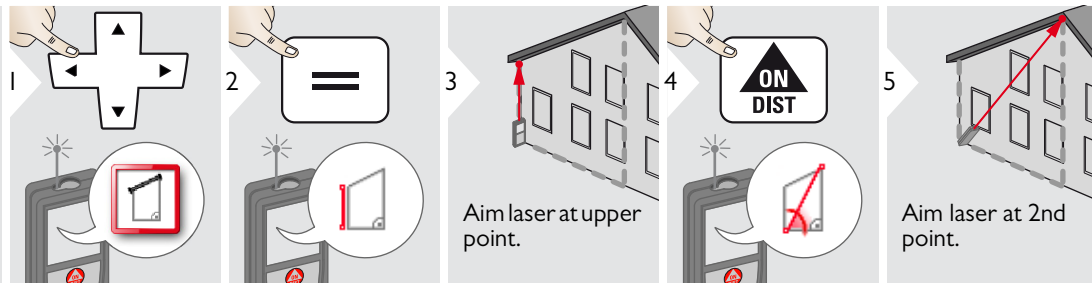

Stake out

1

Two different distances (a and b) can be entered to mark off defined measured lengths.

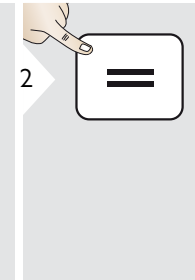
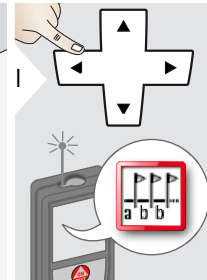
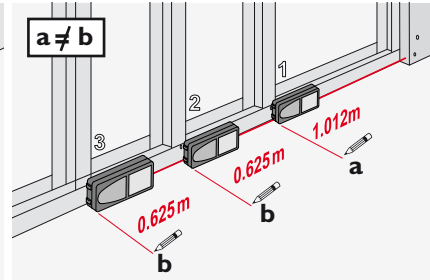
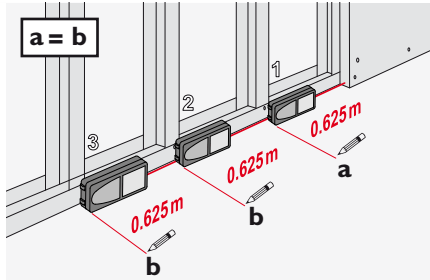

3

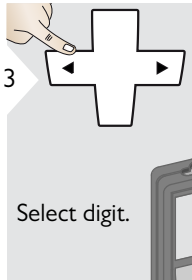

4

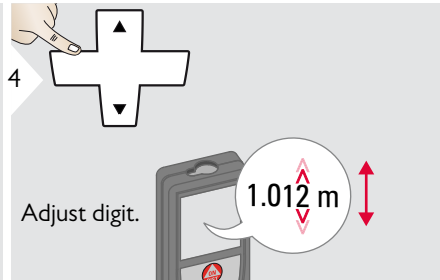

5

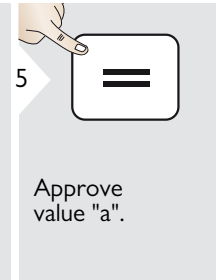

6

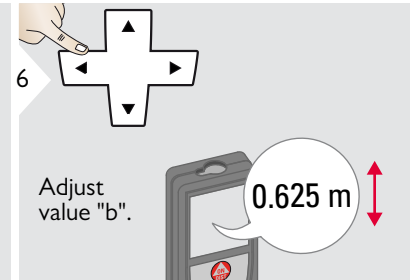

7

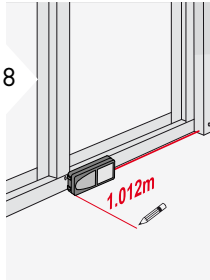

Move device slowly along the stake-out line. The distance to the next stake out point is displayed.

0.240 m is missing up to next 0.625 m distance.

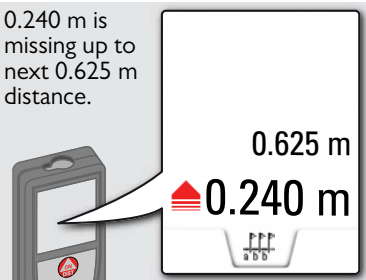

1

When approaching a stake out point to less than 0.1 m the instrument starts to beep. The function can be stopped by pressing the CLEAR/OFF button.

 **Pythagoras (2-point)**

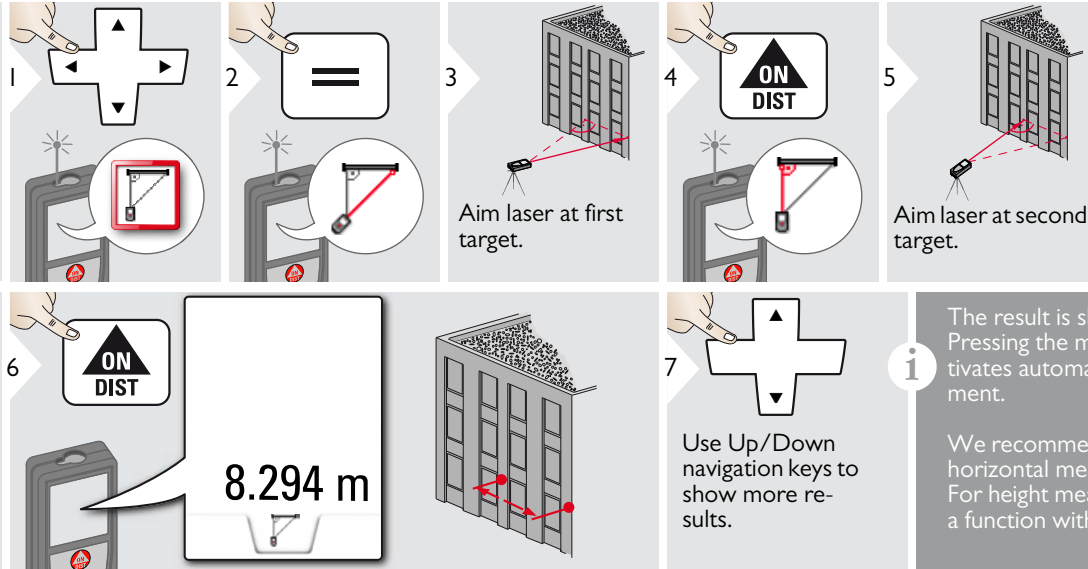

1 

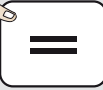
2 

3 Aim laser at first target.

4 

5 Aim laser at second target.

6  8.294 m

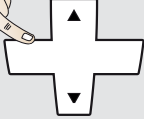
7  Use Up/Down navigation keys to show more results.

i The result is shown in the main line. Pressing the measuring key for 2 sec in the function activates automatically Minimum or Maximum measurement.

We recommend to use the pythagoras only for indirect horizontal measuring. For height measuring (vertical) it is more precise to use a function with the inclination measuring.

Pythagoras (3-point)

1

2

3 Aim laser at first target.

4 ON DIST

5 Aim laser at second target.

6 ON DIST

7 Aim laser at third target.

8 18.294 m

9 Use Up/Down navigation keys to show more results.

i The result is shown in the main line. Pressing the measuring key for 2 sec in the function activates automatically Minimum or Maximum measurement.

We recommend to use the pythagoras only for indirect horizontal measuring. For height measuring (vertical) it is more precise to use a function with inclination measurement.

Distance measurement	
Typical Measuring Tolerance*	± 1.0 mm / ~1/16" ***
Maximum Measuring Tolerance**	± 2.0 mm / 0.08 in ***
Typical Range*	200 m / 660 ft
Range at unfavourable condition ****	80 m / 260 ft
Smallest unit displayed	0.1 mm / 1/32 in
Power Range Technology™	yes
∅ laser point at distances	6 / 30 / 60 mm (10 / 50 / 100 m)
Tilt measurement	
Measuring tolerance to laser beam*****	± 0.2°
Measuring tolerance to housing*****	± 0.2°
Range	360°
General	
Laser class	2
Laser type	635 nm, < 1 mW
Protection class	IP65 (dust tight and jet water protected)
Autom. laser switch off	after 90 s
Autom. power switch-off	after 180 s
Bluetooth® Smart	Bluetooth v4.0
Battery durability (2 x AA)	up to 5000 measurements
Dimension (H x D x W)	143 x 58 x 29 mm 5.6 x 2.28 x 1.14 in
Weight (with batteries)	198 g / 6.37 oz
Temperature range:	
- Storage	-25 to 70 °C -13 to 158 °F
- Operation	-10 to 50 °C 14 to 122 °F

* applies for 100 % target reflectivity (white painted wall), low background illumination, 25 °C

** applies for 10 to 100 % target reflectivity, high background illumination, - 10 °C to + 50 °C

*** Tolerances apply from 0.05 m to 10 m with a confidence level of 95%. The maximum tolerance may deteriorate to 0.1 mm/m between 10 m to 30 m, to 0.20 mm/m between 30 m to 100 m and to 0.30 mm/m for distances above 100 m

**** applies for 100 % target reflectivity, background illumination of approximately 30'000 lux

***** after user calibration. Additional angle related deviation of +/- 0.01° per degree up to +/- 45° in each quadrant. Applies at room temperature. For the whole operating temperature range the maximum deviation increases by +/- 0.1°.

i For accurate indirect results, the use of a tripod is recommended. For accurate tilt measurements a transverse tilt should be avoided.

Functions	
Distance measuring	yes
Min/Max measuring	yes
Permanent measuring	yes
Stake-out	yes
Addition/Subtraction	yes
Area	yes
Triangle area	yes
Volume	yes
Trapezium	yes
Painter function (area with partial measur.)	yes
Pythagoras	2-point, 3-point
Smart Horizontal Mode / Indirect height	yes
Height-profile measurement	yes
Inclination tracking	yes
Sloped objects	yes
Height tracking	yes
Memory	30 displays
Beep	yes
Illuminated colour display	yes
Multifunctional endpiece	yes
Pointfinder (Viewscreen)	4xZoom
Digital Level	yes
Bluetooth® Smart	yes
Personalized Favorites	yes
Timer	yes
Long Range Mode	yes
Calculator	yes

If the message **Error** does not disappear after switching on the device repeatedly, contact the dealer.

If the message **InFo** appears with a number, press the Clear button and observe the following instructions:

No.	Cause	Correction
156	Transverse tilt greater than 10°	Hold the instrument without any transverse tilt.
162	Calibration mistake	Make sure, the device is placed on a absolutely horizontal and flat surface. Repeat the calibration procedure. If the mistake still occurs, contact your dealer.
204	Calculation error	Perform measurement again.
240	Data transfer error	Repeat procedure.
252	Temperature too high	Let device cool down.
253	Temperature too low	Warm device up.
255	Received signal too weak, measuring time too long	Change target surface (e.g. white paper).
256	Received signal too high	Change target surface (e.g. white paper).
257	Too much background light	Shadow target area.
258	Measurement outside of measuring range	Correct range.
260	Laser beam interrupted	Repeat measurement.

- Clean the device with a damp, soft cloth.
- Never immerse the device in water.
- Never use aggressive cleaning agents or solvents.

Warranty

Lifetime Manufacturer's Warranty

Warranty coverage for the entire usage time of the product according to Leica Geosystems International Limited Warranty. Free of charge repair or replacement for all products that suffer defects as a result of faults in materials or manufacturing, for the entire life of the product.

3 Years no Cost

Guaranteed service should the product become defective and require servicing under normal conditions of use, as described in the user manual, at no additional charge.

To receive the "3 years no cost" period, the product must be registered at www.leica-geosystems.com/registration within 8 weeks of the purchase date. If the product is not registered, a "2 years no cost" period applies.

The person responsible for the instrument must ensure that all users understand these directions and adhere to them.

Areas of responsibility

Responsibilities of the manufacturer of the original equipment:

The company above is responsible for supplying the product, including the User Manual in a completely safe condition.

The company above is not responsible for third party accessories.

Responsibilities of the person in charge of the instrument:

- To understand the safety instructions on the product and the instructions in the User Manual.
- To be familiar with local safety regulations relating to accident prevention.
- Always prevent access to the product by unauthorised personnel.

Permitted use

- Measuring distances
- Tilt measurement
- Data transfer with Bluetooth®

Prohibited use

- Using the product without instruction
- Using outside the stated limits
- Deactivation of safety systems and removal of explanatory and hazard labels
- Opening of the equipment by using tools (screwdrivers, etc.)
- Carrying out modification or conversion of the product
- Use of accessories from other manufacturers without express approval
- Deliberate dazzling of third parties; also in the dark
- Inadequate safeguards at the surveying site (e.g. when measuring on roads, construction sites, etc.)
- Deliberate or irresponsible behaviour on scaffolding, when using ladders, when measuring near machines which are running or near parts of machines or installations which are unprotected
- Aiming directly in the sun

Hazards in use

WARNING

Watch out for erroneous measurements if the instrument is defective or if it has been dropped or has been misused or modified. Carry out periodic test measurements. Particularly after the instrument has been subject to abnormal use, and before, during and after important measurements.

CAUTION

Never attempt to repair the product yourself. In case of damage, contact a local dealer.

WARNING

Changes or modifications not expressly approved could void the user's authority to operate the equipment.

Limits of use

-  Refer to section "Technical data".
- The device is designed for use in areas permanently habitable by humans. Do not use the product in explosion hazardous areas or in aggressive environments.

Disposal

CAUTION

Flat batteries must not be disposed of with household waste. Care for the environment and take them to the collection points provided in accordance with national or local regulations.

The product must not be disposed with household waste.

Dispose of the product appropriately in accordance with the national regulations in force in your country.



Adhere to the national and country specific regulations.

Product specific treatment and waste management can be downloaded from our homepage.

Electromagnetic Compatibility (EMC)

WARNING

The device conforms to the most stringent requirements of the relevant standards and regulations.

Yet, the possibility of causing interference in other devices cannot be totally excluded.

Use of the product with Bluetooth®

WARNING

Electromagnetic radiation can cause disturbances in other equipment, in installations (e.g. medical ones such as pacemakers or hearing aids) and in aircraft. It can also affect humans and animals.

Precautions:

Although this product conforms to the most stringent standards and regulations, the possibility of harm to people and animals cannot totally be excluded.

- Do not use the product near petrol stations, chemical plants, in areas with a potentially explosive atmosphere and where blasting takes place.
- Do not use the product near medical equipment.
- Do not use the product in airplanes.
- Do not use the product near your body for extended periods.

Laser classification

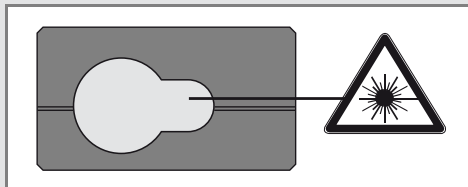

The device produces visible laser beams, which are emitted from the instrument: It is a Class 2 laser product in accordance with:

- IEC60825-1 : 2007 „Radiation safety of laser products“

Laser Class 2 products:

Do not stare into the laser beam or direct it towards other people unnecessarily. Eye protection is normally afforded by aversion responses including the blink reflex.

WARNING

Looking directly into the beam with optical aids (e.g. binoculars, telescopes) can be hazardous.

CAUTION

Looking into the laser beam may be hazardous to the eyes.

Labelling

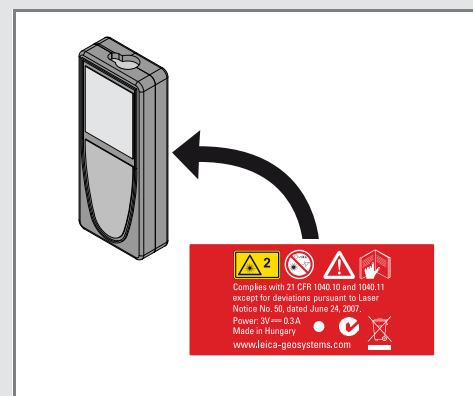
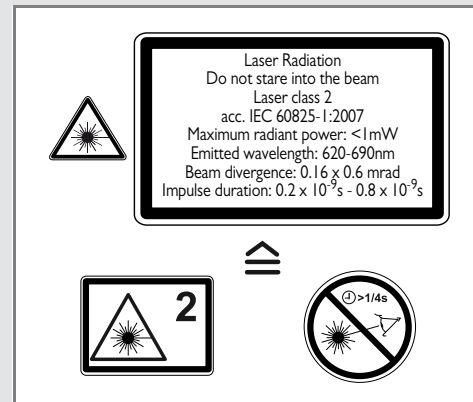

Subject to change (drawings, descriptions and technical data) without prior notice.