

QUICK START GUIDE

HI 903

KARL FISCHER

VOLUMETRIC TITRATOR

Revision 1.0

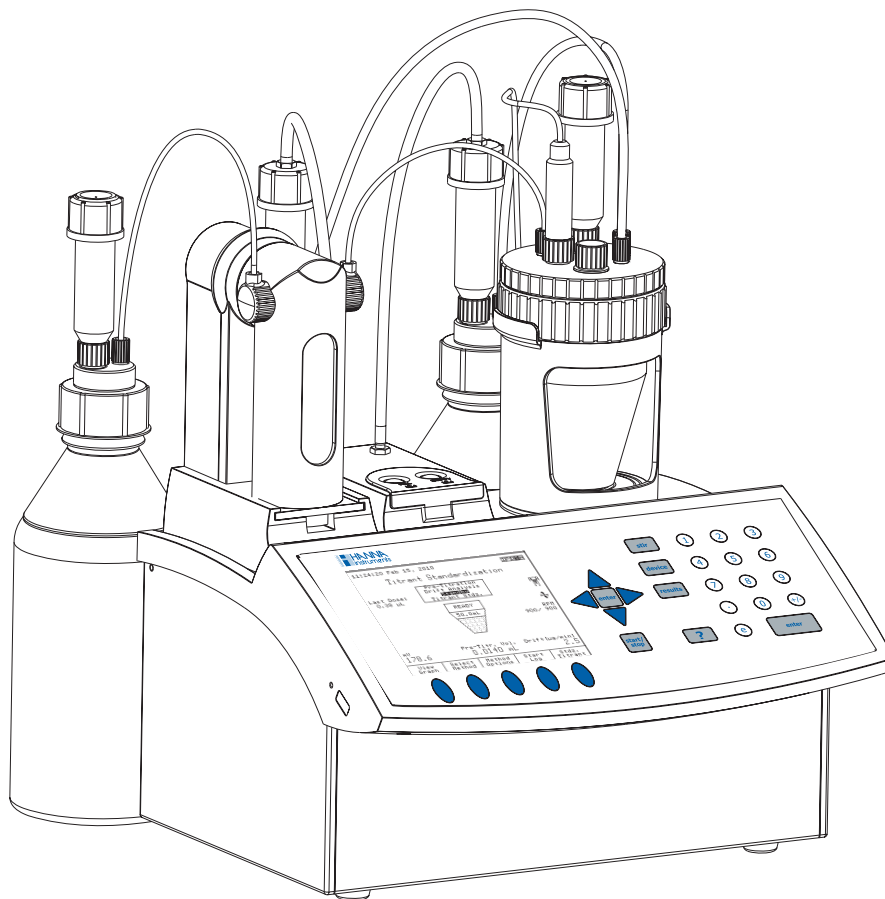

QUICK START GUIDE

Dear customer,

Congratulations on choosing a Hanna Instruments Product.

This guide has been written for the HI 903 Karl Fischer Volumetric Titrator.

Please read this Quick Start Guide carefully before using the instrument. This guide will provide you with the necessary information for the correct use of the instrument.

The purpose of this guide is to present a quick overview of setting up and using the instrument.

For detailed information illustrating the extensive capabilities of your titrator, please refer to the Instruction Manual.

© 2010 Hanna Instruments

All rights are reserved. Reproduction in whole or in part is prohibited without the written consent of the copyright owner, Hanna Instruments Inc., 584 Park East Drive, Woonsocket, Rhode Island, 02895, USA.

Contents

INTRODUCTION3

SAFETY MEASURES.....4

TITRATOR CONNECTIONS5

USER INTERFACE6

HOW TO SELECT YOUR LANGUAGE7

HOW TO USE THE CONTEXTUAL HELP7

METHODS7

BEFORE PERFORMING THE FIRST TITRATION.....8

HOW TO PERFORM THE FIRST TITRATION9

INTRODUCTION

The HI 903 Karl Fischer volumetric titrator is extremely flexible, capable of performing a wide variety of highly accurate and precise water content titration methods.

The HI 903 finds a titration endpoint using a polarized electrode and an advanced detection algorithm. A constant flow of current is maintained between the two platinum pins of the titrator's electrode. When the solution in the titration vessel contains water, a relatively large voltage is required to maintain the flow of current between the pins. As the titration proceeds, the water in the sample is consumed by the titrant. At the end point, all of the water has been reacted and the cell contains excess iodine. The presence of excess iodine within the titration cell results in a reduction in the amount of voltage required to maintain the constant current between the pins of the electrode. The endpoint detection algorithm incorporated in the HI 903 analyzes both the electrode response to individual additions of titrant and the shape of the entire titration curve in order to determine the endpoint of the titration.

Titration reports and methods can be transferred to a PC via a USB interface, saved to a USB flash drive or printed directly from the titrator. An external monitor and keyboard can be attached for added convenience.

How can I find certain information?

1. This **Quick Start Guide** will help the user learn how to operate the titrator within a short period of time. The first analysis will be performed with the aid of the factory stored methods.
2. The **Instruction Manual** provides a complete description of the operating principles (user interface, general options, methods, titration mode, maintenance, etc.).
3. The contextual **Help** screens contain detailed explanations about what kind of data can be set or viewed in every displayed screen.
4. The **Titration Theory** booklet outlines the basic concepts of titration.

QUICK START GUIDE

SAFETY MEASURES

The following safety measures must be followed:

1. Always ensure that the power supply cable is connected to a grounded main power plug.
2. Never connect or disconnect the pump assemblies with the titrator turned on.
3. Verify that the burette and the attached tubing are as described in this guide.
4. Always check that the titrant, solvent and waste bottles, as well as the titration beaker are properly assembled.
5. Always wipe up spills and splashes immediately.
6. Avoid the following environmental working conditions:
 - Severe vibrations
 - Direct sunlight
 - Atmospheric relative humidity above 80% non-condensing
 - Environment temperatures below 10°C and above 40°C.
 - Near heating or cooling sources
 - Explosion hazards
7. Have the titrator serviced by qualified service personnel only.
8. Avoid inhalation of titrant/solvent vapors. Avoid contact with chemicals.

TITRATOR CONNECTIONS

Front View

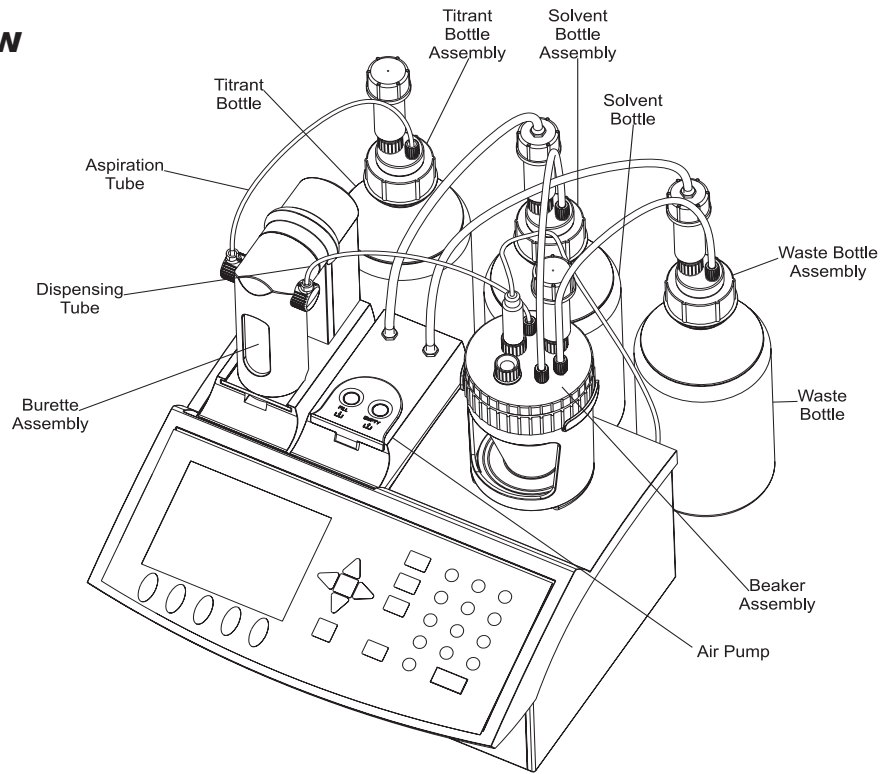

Rear View

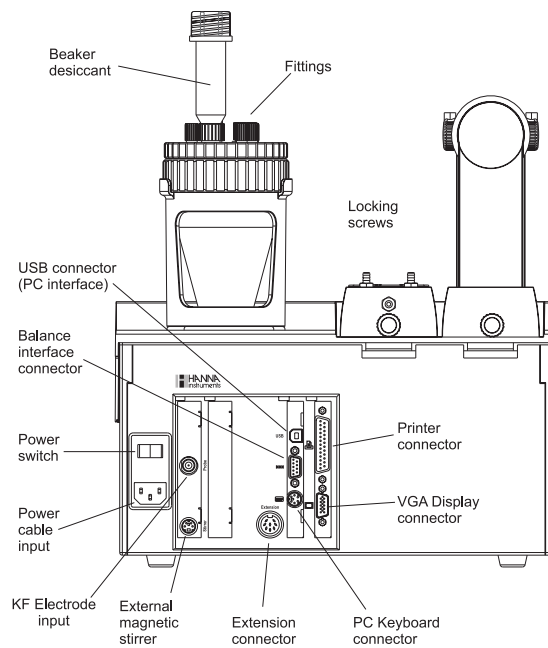

QUICK START GUIDE

USER INTERFACE

Keypad

The titrators have their own keypad with 29 keys grouped in four categories, as follows:

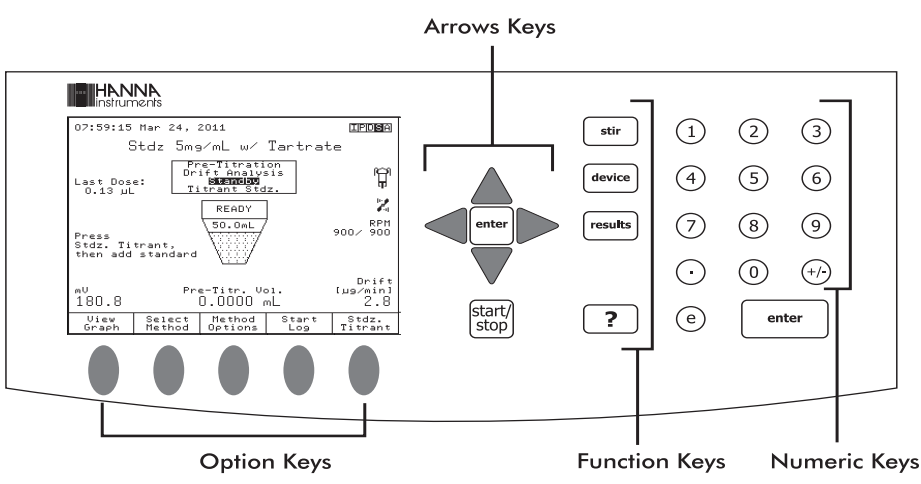

Display

The titrators have a 5.7" graphical backlit color display. The *Standby Mode* screen is shown

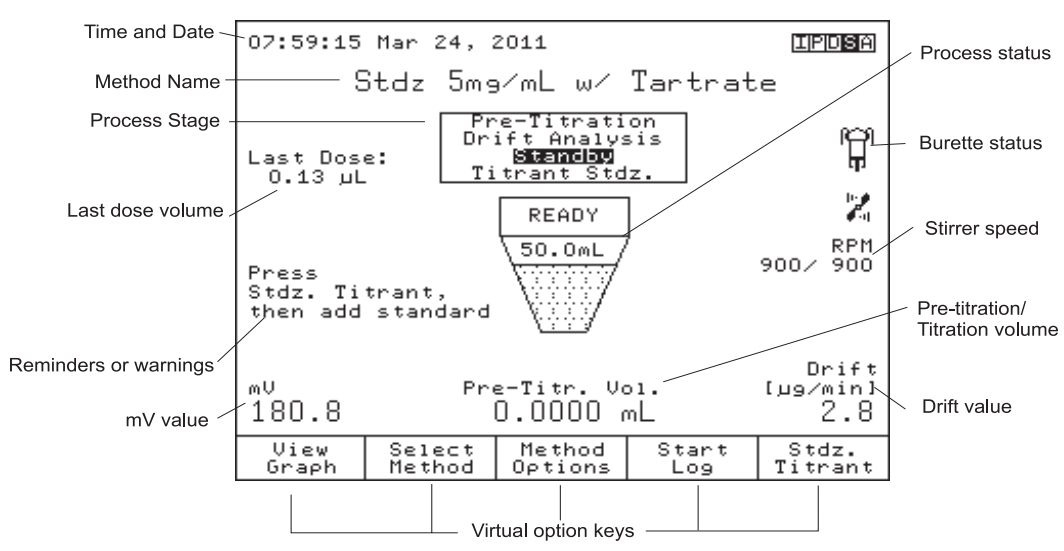





below with short explanations.

The user interface contains several screens. In each screen, many information fields are present at the same time. The information is displayed in an easy-to-read manner, using different size fonts.

Virtual option keys describe the function performed when the corresponding soft key is pressed.

HOW TO SELECT YOUR LANGUAGE

To change the language, press  from the main screen. Highlight the *Language* option and then press . Using the  and  keys select the language from the options listed in the **Set Language** screen and press .

Restart the titrator in order to apply the new language setting.

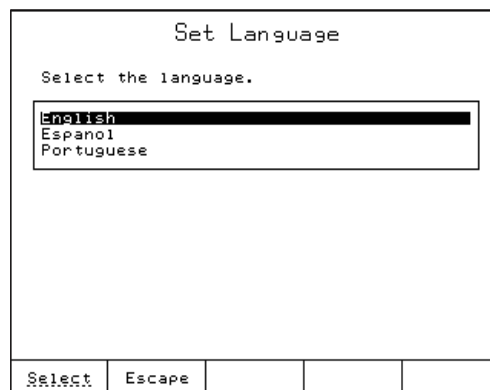

HOW TO USE THE CONTEXTUAL HELP

Any information about the titrator can be easily accessed by pressing . The contextual help can be accessed at any time and it provides useful information about the current screen.

METHODS

The HI 903 Karl Fischer titrator can store up to 100 methods: these include up to 90 standard methods.

Standard Methods

Each titrator is supplied with a customized package of standard methods. Standard method packs are developed at Hanna Instruments laboratories to meet analysis requirements of specific industries.

User-Defined Methods

User-defined methods allow the user to create and save their own methods. Each new method is typically based on an existing method which is altered to suit a specific application.

QUICK START GUIDE

BEFORE PERFORMING THE FIRST TITRATION

Setup the Titrator

- Make sure that all of the titrator assemblies are properly installed (see Instruction Manual, *Setup* section).
- Make sure that the beaker system is properly sealed against atmospheric moisture (the fittings and tubes are correctly mounted).
- The desiccant had been properly dried.

Obtaining the Reagents

- The reagents (titrant and solvent) have to be suitable to the analysis requirements (see Instruction Manual, *Appendix 2* for list of preferred titrants and solvents).

Priming the Burette

- Remove the dispensing tube from titration beaker (unscrew the fitting and remove the tube) and insert it in the waste bottle or separate waste container.
- From the *Idle* screen press .
- Highlight the *Prime Burette* option and then press .
- Enter the number of burette rinses. At least 3 rinses with the solution used for titration are recommended (allowing air bubbles to be evacuated).
- Press to start.
- The message "Executing..." will be displayed.

Note: Make sure you have continuous liquid flow inside the burette. Do not use during normal filling of the burette if you are not sure that air bubbles have been completely evacuated. For accurate results, the aspiration tube, the dispensing tube and the syringe must be free of air bubbles.

- Carefully wipe the end of the dispensing tube to remove excess titrant.
- Insert the dispensing tube in the corresponding hole of the titration beaker and screw the fitting to seal the beaker.

HOW TO PERFORM THE FIRST TITRATION

Method Selection

For this analysis we will use the **HI8301EN Solvent with 5mg/ml 1-component Titrant** standard method.

To select this method:

- Press from the *Idle* screen. Use the \triangle and ∇ keys to highlight the **HI8301EN Solvent with 5mg/ml 1-component Titrant** method.
- Press .

After accomplishing these operations, the method's name will be displayed on the top line of the *Idle* screen.

Setting Method Parameters

To display the method parameters, press . The **View/Modify Method** screen will be displayed.

Only certain parameters from the standard methods can be changed.

For this titration, only the KF titrant concentration value and the size of the solvent sample need to be entered as in the screen shown below.

To accomplish this:

- Highlight *Titrant* option from the **View/Modify Method** screen and then press .
- The **Karl Fischer Titrants** screen will be displayed.
- Press .
- Highlight "*Standardized Titrant Concentration*" and press .
- Input the correct value, then press .
- Press three times to return to the *Idle* screen.







Setup Titration Report

Users can select the information that is stored for each titration that is performed.

To obtain proper information at the end of the titration, perform the following operations:



- From the main screen, press and the **Data Parameters** screen will be displayed.

QUICK START GUIDE

- Highlight the *Setup Titration Report* option and press .
- Mark the fields to be included with the "*" symbol using the  and  keys and press  to toggle the selection.
- Press  and then press  to return to the main screen.



Fill Titration Beaker with Solvent

The titration beaker must be filled with 1-component up to the MIN marker (about 50 mL of solvent):

- From the *Idle* screen, press .
- Push and hold the **FILL** button located on the top of the air pump.
- Wait until the beaker is filled up to the MIN marker with solvent.
- Stop the air pump by pressing  and then confirm the approximate amount of solvent in the beaker.

Prepare the Solvent for Samples

Before beginning a titration, residual moisture inside the titration beaker and solvent must be reacted:

- From the *Idle* screen, press . The titrator will enter Pre-Titration mode, start the magnetic stirrer, and begin dosing titrant into the titration beaker. If no titrant can be seen moving through the anti-diffusion tip after several doses, press  and verify that no titrant is leaking from the burette housing or from the dispensing tube fittings.
- Once all residual moisture has been reacted (endpoint potential is reached), the titrator will enter Drift Analysis mode (assuming Automatic Drift Entry is selected). The titrator calculates the rate of atmospheric moisture seeping into the titration beaker for the next minute and displays the result in the lower right corner of the display.
- If the Drift Rate is stable and the endpoint potential is maintained, the titrator will enter Standby mode. The titrator continues to maintain the endpoint potential and update the background drift rate.

Preparing and Introducing the Sample

Sample Mass Preparation

Measuring the sample size by mass using an analytical balance will give the most reproduc-

ible results.

Solid Samples:

- Solid samples with larger pieces may need to be pulverized or ground in an analytical mill. These samples can be added with a weighing boat by removing the sample port plug.
- Semisolid samples with non-homogeneous water content may need to be homogenized before addition. The sample can be added using a syringe without the needle by removing the sample port plug.

Liquid Samples:

- Samples with low viscosity will be added using a syringe with needle (injection through the septum).

Weigh the syringe before and after injection in order to increase precision.

Sample Volume Preparation

Liquid samples with low viscosity can be added by volume. Samples should be added using a class A pipette.

Note: When adding samples using the weighing boat, pipette or syringe without needle, the septum has to be removed. Therefore the adding operation should be performed quickly in order to avoid the prolonged exposure of the beaker to atmospheric moisture.

Performing a Titration

- From the main screen press Start Analysis for analyzing a sample or Start Stdz. for titrant standardization. You will be prompted to enter the analyte size. Add a prepared sample according to a preparation method outlined above. Enter the analyte size and press Start Analysis or Start Stdz.. The titrator will start the analysis according to the selected method.
- At the end of the titration, the message "Titration Completed" will appear on the titration status, together with the final concentration of the moisture in the sample, the end point volume, and other relevant information. The titrator re-enters *Standby* mode (if active) in the background.

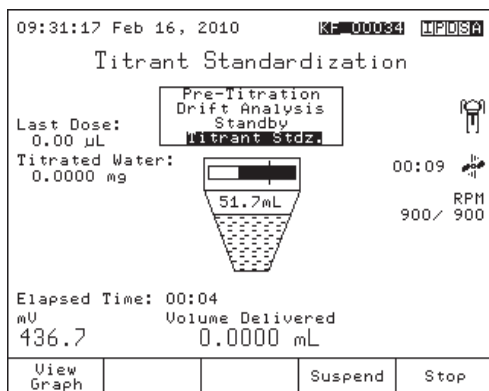

QUICK START GUIDE

Understanding the Displayed Information

During a titration, the following screen is displayed:

Viewing Graph During Titration

Press to display the real time titration graph.

The curve displayed is a plot of Electrode Potential vs. Titrant Volume.

A dashed horizontal line represents the user selected end point potential.

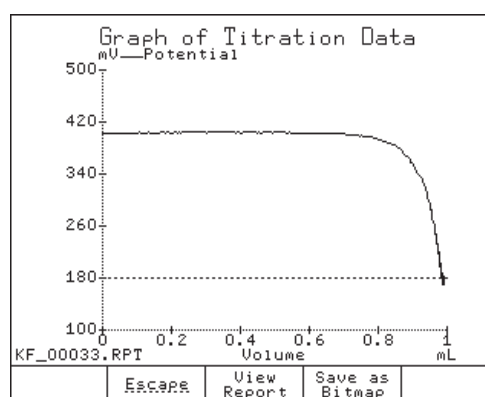
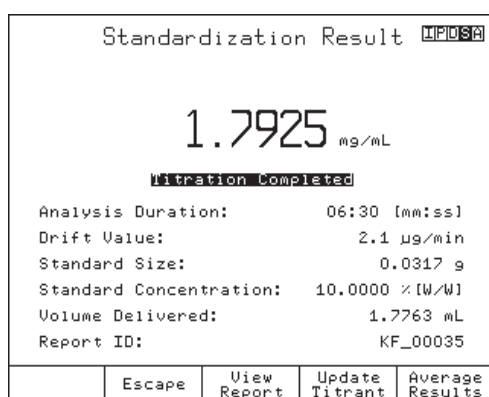

Titration Termination

The titration is terminated when the conditions of the Termination Criteria have been met. The default Termination Criterion is a mV value, in which the titration is terminated after the mV value remains below the end point potential for the selected stability time.

When the titration has ended, the titrator will display the final concentration of the moisture together with the basic titration information.

To view the custom report or titration graph, press .

To view statistics of multiple analyses, press .

For titrant standardizations, press to update the active titrant with the displayed standardization result.

When done, press to return to standby mode (if active).

Results

The results obtained from titration are stored in a report file that can be displayed, transferred to a USB storage device or a PC, or printed.

Viewing the last titration data

- Press (while no titration is being performed).
- The **Data Parameters** screen will be displayed.
- From the **Data Parameters** screen highlight the

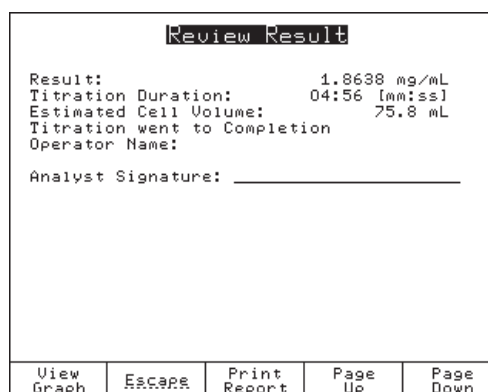

Review *Last Titration Report* option and press Select.

- The **Review Result** screen will be displayed.
- Use the Page Up and Page Down keys to display information related to the last titration performed.

See *titration report* on page 15.

Printing the titration report

Connect a DOS / Windows compatible printer directly to the DB 25 connector (parallel port) located on the back of the titrator.

Note: To connect the printer, please turn off the titrator and the printer.

Printing out the report:

- From the **Review Report** screen, press Print Report.
- During the information transfer to the printer, the message "Printing" will be displayed on the screen.
- Press Escape to return to the **Data Parameters** screen.
- Press Escape again to return to the main screen.

Saving the data on a USB storage device

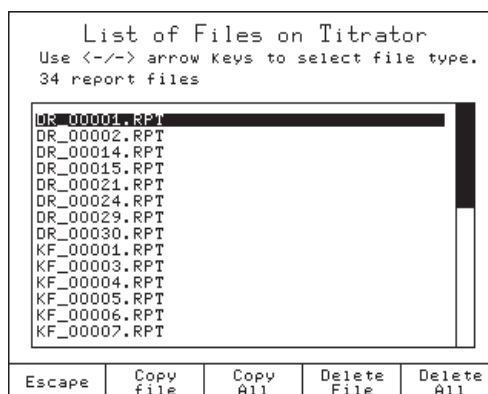

This feature allows saving the results of titrations or drift logging sessions on a USB storage device.

- Insert the USB storage device into the USB socket.
- From the *Idle* screen, press General Options. The **General Options** screen will be displayed.
- Highlight the *Save Files to USB Storage Device* option using the ▲ and ▼ keys.
- Press Select. The **List of Files on Titrator** screen will be displayed.
- Use the ◀ or ▶ keys to select the file type: "report files".
- Press Copy All to transfer all available reports to USB storage device, or highlight the





QUICK START GUIDE

name of the report file to be transferred and press .

- Transferring a report file will automatically transfer the corresponding log file and titration graph BMP file (if applicable).
- Press , to return to the **General Options** screen.
- Press  again, to return to the *Idle* screen.

Titration report

While scrolling with the  and  keys, the fields below can be seen on the titrator display or printed. The same information is available on the saved report file (KF_00003.rpt in this example, with all report fields selected).

```
HI903 - Titration Report

Method Name:           Moisture in Oil
Time & Date:           12:00 Jan 01, 2011
Titration ID:          KF_00003
Company Name:          Hanna Instruments
Operator Name:         KF Technician
Electrode Name:        Probe 1
Field 1:               Any text
Field 2:               Any text
Field 3:               Any text
Titrator Software Version: v1.0
Base Board Software Version: v2.6
Pump Software Version:  v1.4
Titrator Serial Number: 12345678
Analog Board Serial Number: 12345678
Pump Serial Number:     12345678
Analog Calibration Date: Aug 22, 2010
```

```
Method Parameters

Name:                   Moisture in Oil
Method Revision:        1.0
Type:                   Sample Analysis
Predispensing Rate:     None
Pre-Analysis Stir Time: 0 Sec
Stirring Speed:         900 RPM
Stirbar Type:           Medium
Drift Entry:            Automatic
Solvent:                KF Solvent

Sample Parameters:
  Sample Determ.:       Normal
  Sample Name:          Oil
  Sample Type:          Mass
Sample Size:            0.5000 g
Titrant:                KF Titrant
  Titrant Type:         One Component
  Nominal Titrant Conc.: 2.0000 mg/mL
  Stdz. Titrant Conc.:  2.0000 mg/mL
  Date/Time:            Jan 01, 2011 12:00
  Titrant Age Reminder: 2d:00h:00m

Control Parameters:
  Start Mode:           Normal
  Standby Mode:         Enabled
```

QUICK START GUIDE

Standby Duration: 720 minutes
Imposed Current: 20 uA
Minimum Dose: 0.5000 uL
Maximum Dose: 30.0000 uL
Timed Increment: 1 second
End Point Value: 180.0 mV
Signal Averaging: 3 Readings
Flow Rate: 10.0 mL/min
Termination Parameters:
Maximum Duration: 3600 sec
Maximum Titrant Volume: 20.0000 mL
Term. Criterion: mV End Point
mV End Point: 4 sec
Result Unit: %

Nr	Volume [ml]	mV	Time
0	0.0000	403.6	00:00:00
1	0.0000	403.5	00:00:01
2	0.0028	403.1	00:00:03
3	0.0078	402.3	00:00:05
4	0.0128	402.6	00:00:06
5	0.0178	403.0	00:00:08
6	0.0228	402.5	00:00:09
7	0.0278	402.4	00:00:11
8	0.0328	402.7	00:00:12
9	0.0378	402.5	00:00:14
10	0.0428	402.9	00:00:16
		.	
		.	
		.	
256	0.9904	169.7	00:06:45
257	0.9904	177.4	00:06:47
258	0.9904	173.7	00:06:48
259	0.9904	171.1	00:06:50
260	0.9904	173.4	00:06:52
261	0.9904	181.1	00:06:53
262	0.9904	175.5	00:06:55
263	0.9904	178.2	00:06:56
264	0.9904	177.6	00:06:58

Titration Results

Method Name: Moisture in Oil
Time & Date: 12:00 Jan 01, 2011
Sample Size: 0.5291 g
Titrant Conc.: 2.0000 mg/mL
Drift Value: 1.0 ug/min
End Point Volume: 0.9904 mL
Result: 0.3730 %
Titration Duration: 06:58 [mm:ss]
Estimated Cell Volume: 50.8 mL
Titration went to Completion
Operator Name: Any text
Analyst Signature: _____

OS 903
02/11

INSTRUCTION MANUAL

HI 903

KARL FISCHER

VOLUMETRIC TITRATOR

Revision 1.00

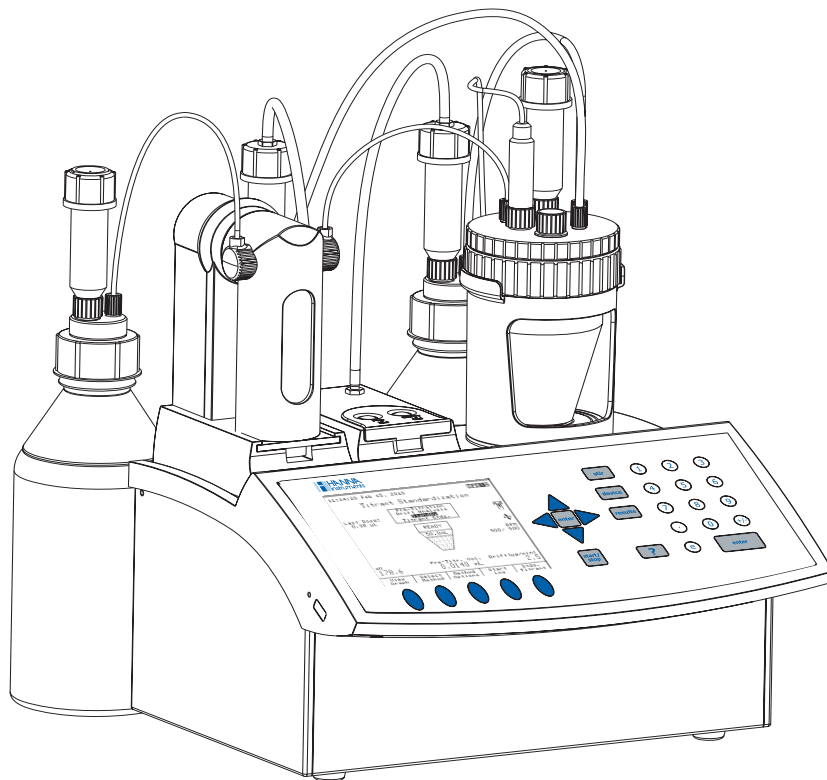

Dear customer,

Congratulations on choosing a Hanna Instruments product.

Please read this instruction manual carefully before using the instrument. This manual will provide you with the necessary information for the correct use of the instrument.

© 2010 Hanna Instruments

All rights are reserved. Reproduction in whole or in part is prohibited without the written consent of the copyright owner, Hanna Instruments Inc., 584 Park East Drive, Woonsocket, Rhode Island 02895, USA.

TABLE OF CONTENTS

- Chapter 1. INTRODUCTION**
 - Chapter 2. SETUP**
 - Chapter 3. USER INTERFACE**
 - Chapter 4. GENERAL OPTIONS**
 - Chapter 5. METHODS**
 - Chapter 6. TITRATION**
 - Chapter 7. AUXILIARY FUNCTIONS**
 - Chapter 8. MAINTENANCE, PERIPHERALS**
 - Chapter 9. OPTIMIZATION**
 - Appendix 1. TECHNICAL SPECIFICATIONS**
 - Appendix 2. RECOMMENDED REAGENTS**
 - Appendix 3. TITRATOR COMPONENTS**
-

1 INTRODUCTION

The HI 903 is an automatic volumetric Karl Fischer titrator with high accuracy, great flexibility and repeatability.

The titrator is designed to perform titrations for a variety of sample types.

The main attributes of this titrator are:

Flexibility	Support up to 100 titration methods (standard and user defined). User defined titrant and standard database.
High accuracy	Precise dosing system, capable of delivering as little as 0.125 μL of titrant with a single dose. Precise mV measurement and current (μA) control.
Repeatability	Powerful built-in algorithms for termination criteria based on fixed mV endpoint or absolute/relative drift.
Quick results	Pre-defined titration methods. Pre-dispensing feature. Dynamic dosing feature. Balance interface for automatic weighing.
Complete report	Results are displayed directly in the selected units along with the titration information. Titration graph can be displayed on the LCD and saved as a bitmap. Customizable titration reports and drift analysis reports can be printed, saved on a USB storage device or transferred to a PC via the USB interface.
Result history	Titration standardization and sample analysis results averaging.
GLP features	Titration age reminder. Fields for specific annotations.
Conditioning phase	Automatic pre-titration for drying the solvent and titration beaker. Drift analysis adjusted titration results for improved accuracy.
Sealed solvent system	Allows full operation in a completely sealed system, minimizing water vapor entry.
Self diagnosis and integrated help	Integrated help screens are available. Self diagnosis features for peripheral devices including pump, valve, burette and stirrer. Error management with warning and error messages.
Large graphical display	5.7" (320 x 240 pixels) graphical color display with backlight. Easy to view text and graphs. User friendly interface.

This manual provides information regarding installation and functionality of the titrator and refined operation suggestions.

Before using the titrator it is recommended you become familiar with its various features and functionality.

Chapter 2. Contents

2	SETUP	2 - 3
2.1	Unpacking	2 - 3
2.2	Safety Measures	2 - 4
2.3	Installation	2 - 5
2.3.1	Titrator Top View	2 - 5
2.3.2	Titrator Rear View	2 - 6
2.3.3	Titrator Left-side View	2 - 6
2.3.4	Titrator Assembly	2 - 7
2.3.4.1	Connecting the Pumps	2 - 7
2.3.4.2	Attaching the Burette	2 - 9
2.3.4.3	Attaching the Beaker and Dispensing Tip	2 - 10
2.3.4.3.1	Beaker Top	2 - 11
2.3.4.4	Electrical Connections	2 - 13
2.3.5	Titrant, Solvent, Waste Bottle Assembly	2 - 14
2.3.5.1	Titrant Bottle Assembly	2 - 14
2.3.5.2	Solvent / Waste Bottle Assembly	2 - 15

2 SETUP

2.1 Unpacking

The titrator and the accessories are shipped in a single box containing:

ITEM	QUANTITY
1 Titrator	1 pcs.
2 Dosing Pump Assembly	1 pcs.
3 Burette Assembly	1 pcs.
• Burette (with 5 mL syringe)	
• Aspiration Tube with Fittings and Protection Tube	
• Dispensing Tube with Anti-Diffusion Tip, Fittings, and Protection Tube	
• Tube Locks	
• Tool for Burette Cap Removal	
• Light Protection Screen	
4 Air Pump Assembly	1 pcs.
5 Beaker Assembly	1 pcs.
• Glass Beaker	
• Beaker Ring	
• Beaker Cap	
• Stir Bar	
• Desiccant	
• Desiccant Cartridge	
• Fittings, O-rings	
6 Beaker Support	1 pcs.
7 Pump Locking Screws with Plastic Head	2 pcs.
8 Titrant Bottle Assembly	1 pcs.
• Bottle Cap	
• Desiccant	
• Desiccant Cartridge	
• Fittings, O-rings	
9 Solvent Bottle Assembly	1 pcs.
• Bottle Cap	
• Desiccant	
• Desiccant Cartridge	
• Fittings, O-rings	
• Tubes (Silicon and Teflon Tubing)	

SETUP

10	Waste Bottle Assembly	1 pcs.
	• Bottle Cap	
	• Desiccant	
	• Desiccant Cartridge	
	• Fittings, O-rings	
	• Tubes (Silicon and Teflon Tubing)	
11	Calibration Key	1 pcs.
12	Power Cable	1 pcs.
13	USB Cable	1 pcs.
14	Instruction Manual Binder	1 pcs.
15	USB Storage Device	1 pcs.
16	HI 900 PC Application (Install Kit on USB Stick)	1 pcs.
17	Quality Certificate	1 pcs.
18	ISO 8655 Burette Compliance Report	1 pcs.
19	Karl Fischer Dual Platinum Pin Electrode	1 pcs.

See **Appendix 3** section **A 3 Titrator components** for pictures.

If any of the items are missing or damaged, please contact your sales representative.

Note: *Save all packing materials until you are sure that the instrument functions correctly. Any damaged or defective items must be returned in their original packing materials together with the supplied accessories.*

2.2 Safety Measures

The following safety measures must be followed:

1. Always ensure that the power-supply cable is connected to a grounded main power plug.
2. Never connect or disconnect the pump assembly with the titrator turned on.
3. Verify that the burette and the attached tubing are assembled correctly (see *Section 8.1 Burette Maintenance* for more details).
4. Always check that the titrant, solvent, waste bottles and the titration beaker are properly assembled.
5. Always wipe up spills and splashes immediately.

6. Avoid the following environmental working conditions:

- Severe vibrations
- Direct sunlight
- Atmospheric relative humidity above 95% non-condensing
- Environment temperatures below 10°C and above 40°C
- Explosion hazards

7. Have the titrator serviced only by qualified service personnel.

2.3 Installation

2.3.1 Titrator Top View

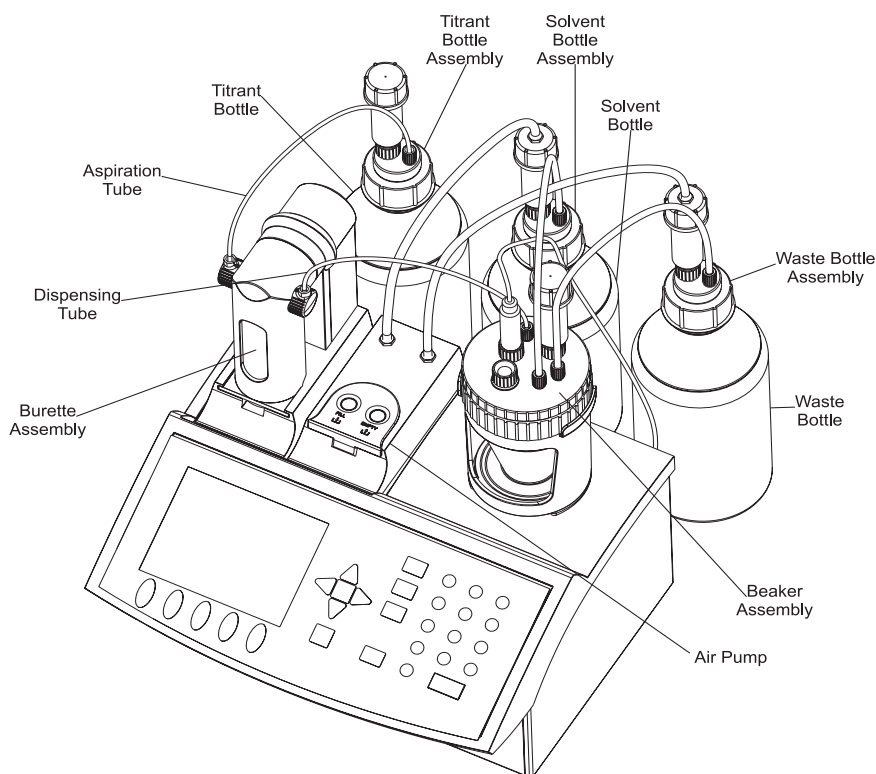

SETUP

2.3.2 Titrator Rear View

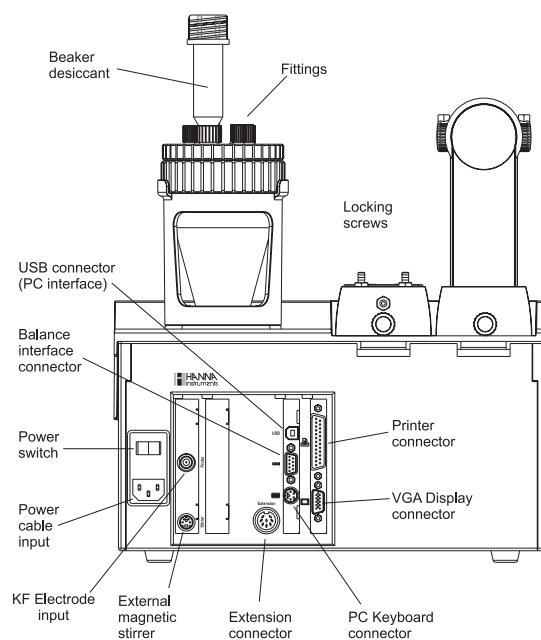

2.3.3 Titrator Left-side View

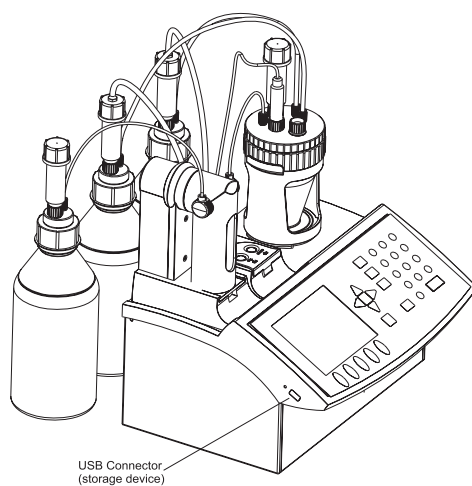

2.3.4 Titrator Assembly

Note: Assembly operations must be completed before connecting the titrator to the power supply!

2.3.4.1 Connecting the Pumps

Dosing Pump:

The dosing pump is driven by a stepper motor, which provides 40,000 steps for a single burette volume.

The pump housing also holds the motor, which automatically positions the valve for filling and dispensing titrant. The dosing pump's integrated sensors electronically recognize the volume of any Clip-lock™ exchangeable burette system syringe.

Connect the dosing pump with the following steps (see Figure 1.):

- (1) Retrieve the pump cable (PUMP 1) from inside the left bay. Connect the cable to the pump as shown in Figure 1. The pump connector is located in the lower part of the pump, near the motor.
- (2) Lower the pump into the titrator, then slide it towards the front of the titrator chassis until it is firmly latched.
- (3) Secure the pump with the locking screw.

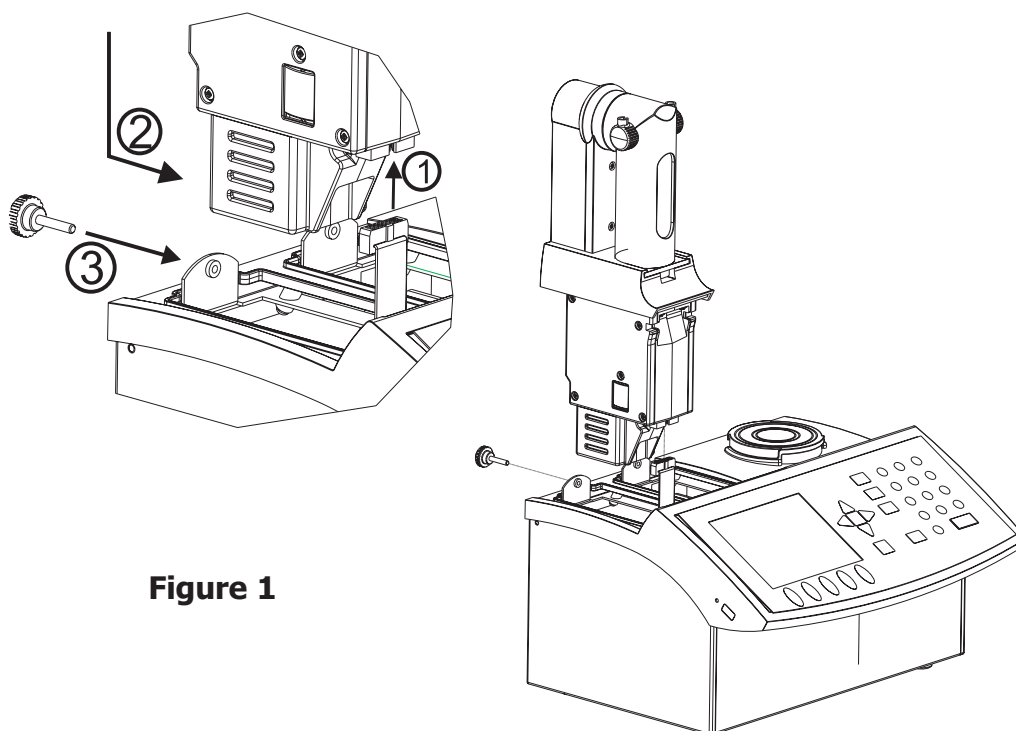

Figure 1

Air Pump:

The diaphragm air pump system is designed to work with the specially designed bottle top assemblies. It allows the solvent in the titration vessel to be removed and/or replaced without opening the titration vessel and exposing the interior of the vessel to ambient moisture from atmospheric humidity.

SETUP

Connect the air pump with the following steps (see Figure 2.):

- (1) Retrieve the air pump cable (PUMP 2) from inside the right bay. Connect the cable to the air pump as shown in Figure 2. The air pump connector is located on the left side of the motor.
- (2) Lower the pump into the titrator, then slide it towards the front of the titrator chassis until it is firmly latched.
- (3) Secure the pump with the locking screw.

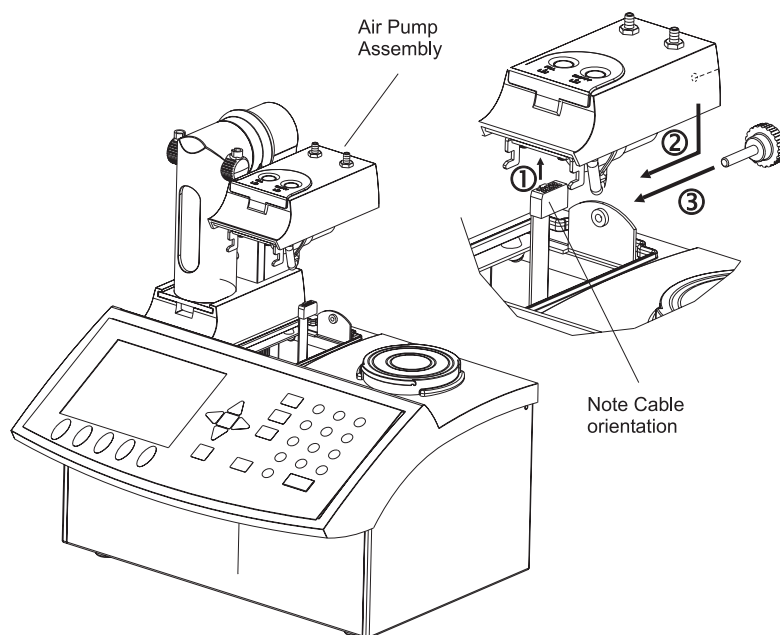

Figure 2

2.3.4.2 Attaching the Burette

The 5 mL glass syringe features a highly precise inner diameter, which has been individually verified to produce consistent titrant dosage according to standard ISO 8655. All of the non-glass, wetted syringe and valve components, including the shoulders and plunger cap, are constructed from PTFE to ensure resistance to both degradation due to Karl Fisher titrant and water vapor permeability.

Make sure that the mark from the valve actuating cap and the burette body are aligned as shown in Figure 3. Make sure that the valve positioning wheel on the burette pump is oriented in the proper position as shown in Figure 5.

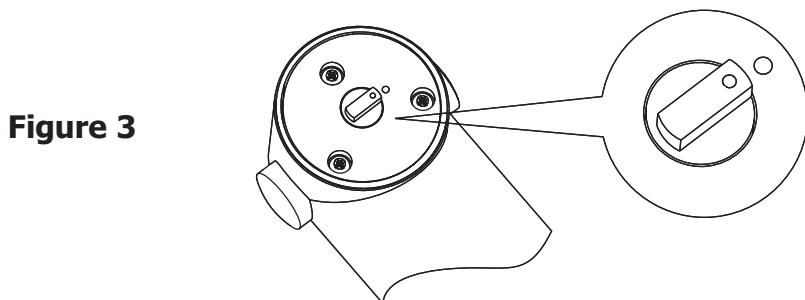

Figure 3

While ensuring the correct coupling between the syringe plunger (A) and the pump piston (B) (see Figure 4), slide the burette into the support on the burette pump (see Figure 5).

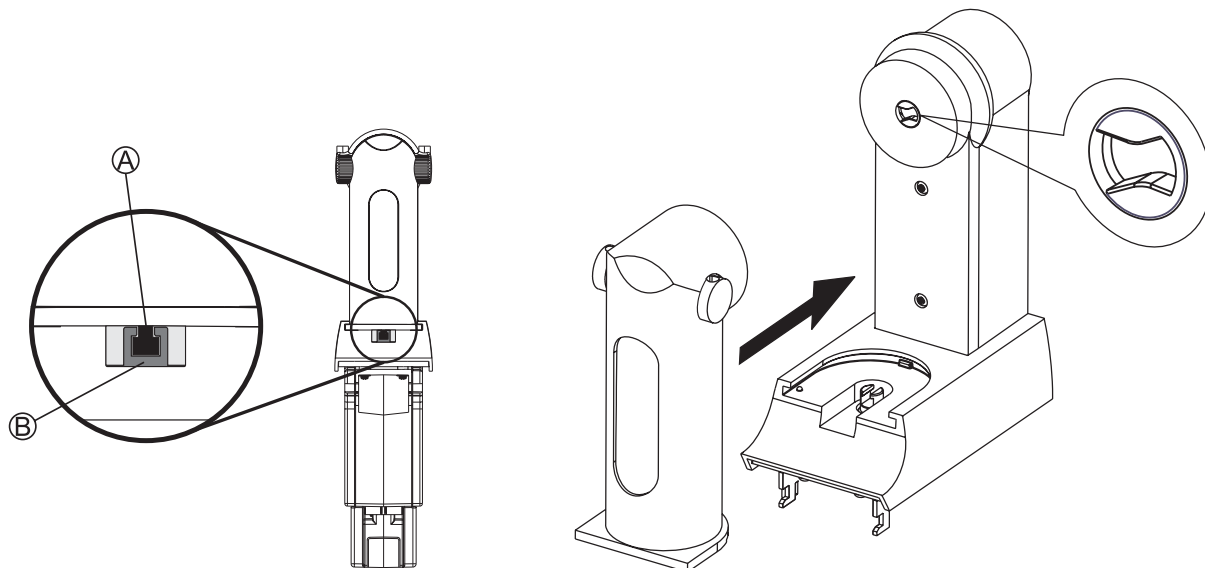

Figure 4

Figure 5

2.3.4.3 Attaching the Beaker and Dispensing Tip

The titration reaction takes place in a closed, conical, glass beaker, sometimes called a titration vessel, reaction vessel, titration cell or reaction cell.

The primary design features of the **HI 903** titration vessel include the following:

- Durability, easy to use, clean and maintain.
- Conical, glass vessel body which provides strong, repeatable mixing for reaction volumes between 50 and 150 mL.
- Tightly sealing PTFE cover with low water vapor permeability and high chemical resistivity to Karl Fischer reagents.
- A sample port which can both be rapidly removed and replaced when adding solid samples and incorporates a septum through which liquid samples can be injected.
- A desiccant cartridge containing molecular sieves and/or indicating silica gel to dry the ambient air which enters the cell as solvent, titrant and sample are added to or removed from the vessel.
- Fittings made from a highly chemically resistant material called PEEK which, in conjunction with o-rings, create tight seals between the vessel top and the electrode, dispensing tip, solvent and waste tubes, sample port and desiccant cartridge.

To attach the beaker assembly, see Figure 6 and follow the steps below:

- Align the beaker support (D) with the base plate and attach by rotating clockwise.

Figure 6

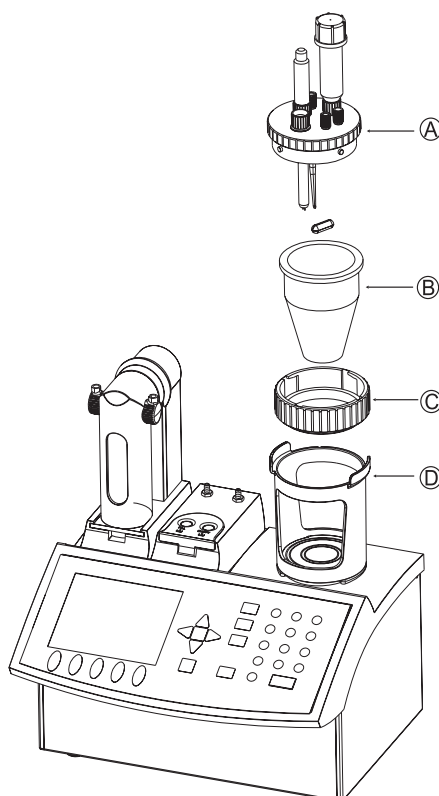

- Place beaker ring (C) onto beaker support with the notches on top (see Figure 6).
- Insert the glass beaker (B) into the beaker ring (C).
- Add the stir bar to the glass beaker (B).
- Carefully place the beaker top onto the beaker (B). Secure in place by pushing the beaker top through the beaker ring (C) with the 4 notches of the beaker ring aligned with the 4 steel pins of the beaker top (A).
- Twist the beaker ring (C) counter-clockwise to lock the top in place.

2.3.4.3.1 Beaker top

Warning: Do not over-tighten fittings! This may cause permanent damage to o-rings!

To assemble the 5 parts of the beaker top, see Figure 7 and follow the steps below:

Figure 7

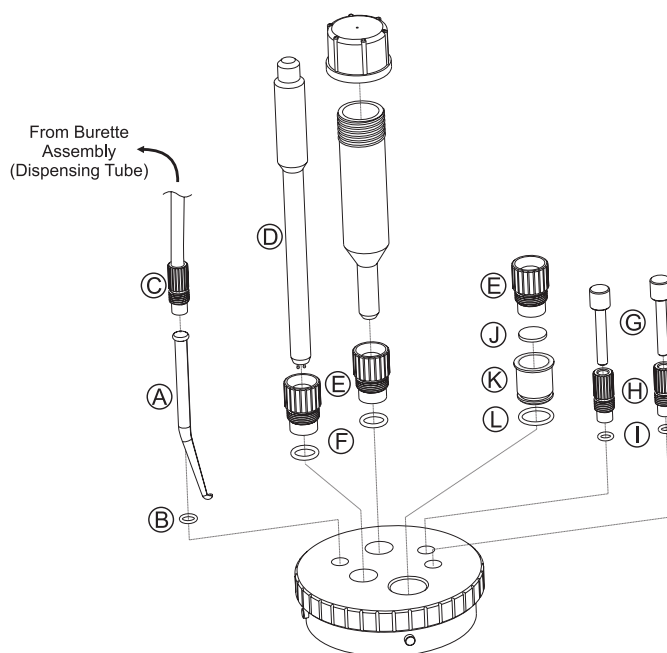

Anti-Diffusion Dispensing Tip

The HI903 ships with the dispensing tip (A) and o-ring (B) installed. For initial setup, go to third step:

- Push dispensing tip (A) through the dispensing tip o-ring (B) until the o-ring is at the lip of the dispensing tip.
- Insert tip through the proper port. Orient the tip so that the angled portion is directed toward the center of the assembly.
- Fasten the dispensing tubing from the burette assembly to the dispensing tip port using the dispensing tip fitting (C). Ensure that the tip remains oriented toward the center of the beaker.

SETUP

Karl Fischer Electrode

The Karl Fischer electrode consists of two parallel, platinum pins sealed into a 10mm diameter glass body. Two steel pins connect the platinum elements to a standard BNC connector, which allows for easy attachment to the **HI 903**.

Attach to the beaker top as follows:

- Carefully insert the electrode through a 10-mm fitting (E) and 10-mm o-ring (F).
- Insert electrode through proper port in beaker top (see Figure 7).
- While orienting electrode with pins aligned to the center of the beaker, fasten the 10-mm fitting (E) to the beaker top. The electrode above stirbar should be as far down into the beaker as possible.
- Attach the electrode connector to the BNC connector on the back of the instrument.

Solvent Handling System

The HI903 ships with white plugs (G) in the solvent ports. To attach solvent bottle tubing or waste bottle tubing, follow the steps below:

- Loosen the 5-mm fitting (H) on the solvent and/or waste port.
- Remove the desired plug/plugs (G).
- Insert the blue teflon tubing from the solvent and/or waste bottle assemblies through the 5-mm fittings (H) and 5-mm o-rings (I) until about 1 cm of tubing is visible inside the beaker.
- Tighten the 5-mm fittings (H) until snug. This will cause the red silicone o-rings (I) to seal around the tubes.

Sample Port Plug

The HI903 ships with the sample port plug assembled and installed. To reassemble, follow the steps below:

- Insert a red rubber septum (J) into the septum holder (K).
- Fasten with a 10-mm fitting (E).
- Place the sample port plug o-ring (L) in the slit of the septum holder (K).
- Insert the assembled sample port plug into the dedicated port of the beaker top.

Desiccant Cartridge

- Insert the stem of a desiccant cartridge (M) with a plain cap (N) through a 10-mm fitting (E) and 10-mm o-ring (F).
- Insert in the proper port of the beaker top.
- Fasten to the top with the 10-mm fitting.

2.3.4.4 Electrical Connections

- Connect the KF electrode to the BNC connector (C).
- Connect the power supply cable to the power supply connector (B).

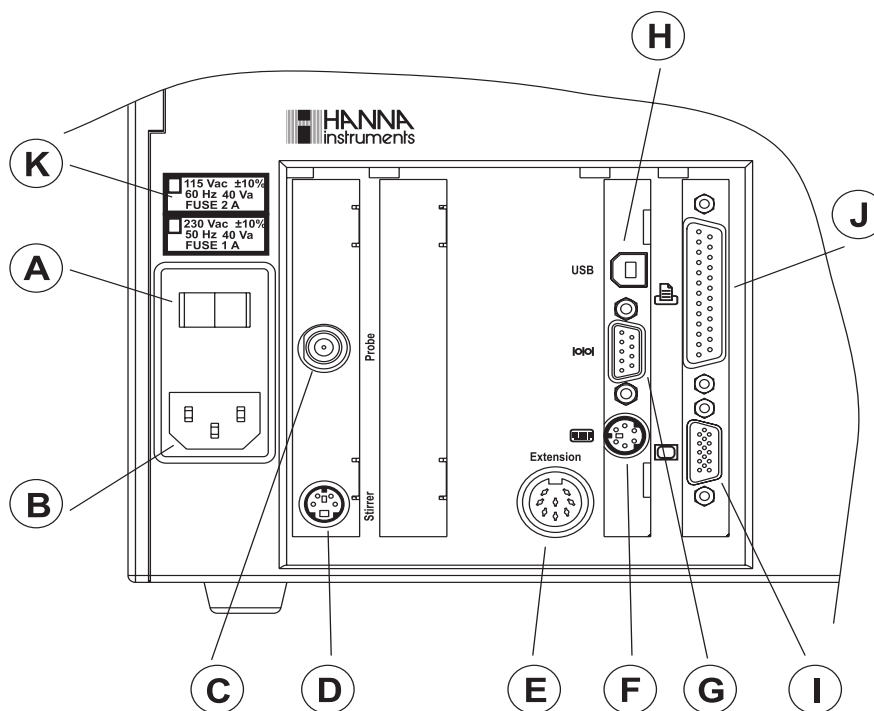

Figure 8

	Function	Type of Connector
A	Power switch	
B	Power supply (115/230 VAC, 50-60 Hz) Check on titrator rear panel (K)	IEC Power line connector
C	KF probe	BNC socket
D	External magnetic stirrer	4-pin mini DIN
E	Connector for expansion device	8-pin DIN socket
F	External PC keyboard	6-pin mini-DIN (Standard PS2)
G	Analytical balance interface (RS232)	Standard DB 9 pin socket
H	PC interface (USB)	USB socket
I	External display	Standard VGA display 15-pin socket
J	Parallel Printer	DB 25-pin socket

SETUP

2.3.5 Titrant, Solvent, Waste Bottle Assembly

The bottle top assemblies are equipped with desiccant cartridges containing *indicating silica gel* which ensures that the air passing through the solvent handling system has been dried. *The desiccant has a limited capacity to absorb moisture and is typically exhausted after 2 to 4 weeks. Silica gel, indicating or otherwise, can be regenerated at 150 °C.*

The bottle tops are constructed of PTFE and have been designed to accommodate reagent bottles with GL-45 type threaded tops.

The waste and solvent bottle top assemblies include blue PTFE tubing blue for the handling of liquid Karl Fischer solvent and a clear flexible silicone based tubing for use with the air pump.

2.3.5.1 Titrant Bottle Assembly (HI 900530)

Caution: Most Karl Fischer titrants give off harmful vapors. Consult manufacturer's MSDS for safe handling guidelines.

To assemble the titrant bottle, see Figure 9 and follow the next steps:

- Insert teflon top (J) into a GL45 screw cap (E).
- Insert a desiccant cartridge (B) without hose-barbed cap (A) through a 10-mm fitting (F) and 10-mm o-ring (G).
- Insert and screw the desiccant cartridge assembly into the corresponding hole in the white teflon top (J). Fasten with 10-mm fitting (F).
- Ensure that the tube protector (C) is installed on the aspiration tubing (D).
- Insert the burette aspiration tubing (D) in the corresponding 3-mm fitting (H) and attach the 3-mm o-ring (I).
- Insert and screw the aspiration tube fitting into the corresponding hole.
- Push the aspiration tubing fully into the titrant bottle until only the tube protector (C) is visible outside of the titrant bottle (K).
- Screw GL45 cap (E) with full assembly onto the titrant bottle (A).

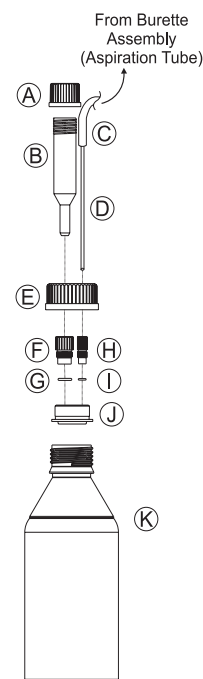

Figure 9

2.3.5.2 Solvent / Waste Bottle Assembly (HI 900531)

Caution: Most Karl Fischer solvents give off harmful vapors. Consult manufacturer's MSDS for safe handling guidelines.

To assemble the solvent or waste bottle, see Figure 10 and follow the next steps:

- Insert a teflon top (J) into a GL45 cap (E).
- Screw on the desiccant cap with hose barb (F);
- Insert a desiccant cartridge (B) with hose-barbed cap (A) through a 10-mm fitting (F) and 10-mm o-ring (G);
- Insert and screw the desiccant fitting into the corresponding hole. Fasten the desiccant cartridge assembly to teflon top (J) with 10-mm fitting (F);
- Insert the solvent / waste tube (D) in the 5-mm fitting (H) and attach the o-ring (I);
- Insert and screw the tube fitting into the corresponding hole.
- Screw GL45 (E) cap with full assembly onto titrant bottle.
- Add the air tube (C) to the desiccant cap (A) and connect it to the corresponding position on the air pump. The "Fill" position connects to the solvent bottle assembly. The "Empty" position connects to the waste bottle assembly.

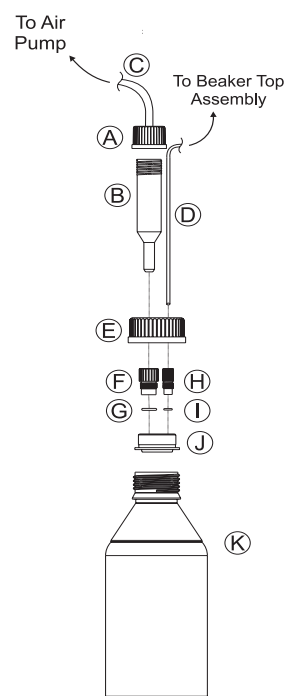

Figure 10

Chapter 3. Contents

3	USER INTERFACE	3 - 3
3.1	Start Up	3 - 3
3.2	Description	3 - 4
3.2.1	Keypad	3 - 4
3.2.1.1	Function Keys	3 - 4
3.2.1.2	Option Keys	3 - 4
3.2.1.3	Arrow Keys	3 - 5
3.2.1.4	Numeric Keys	3 - 5
3.2.1.5	Enter Key	3 - 5
3.2.2	Display	3 - 5
3.2.3	The Idle Screen	3 - 6
3.2.4	The Process Screen	3 - 7
3.3	Menu Navigation	3 - 8
3.3.1	Selecting an Option	3 - 8
3.3.2	Selecting a Menu Item	3 - 8
3.3.3	Entering Text	3 - 8
3.3.4	Saving Modifications	3 - 9

3 USER INTERFACE**3.1 Start Up**

Once the instrument is assembled and installed, follow the steps below to start the titrator:

- Connect the instrument to an outlet equipped with a ground wire. Make sure that the voltage of the main power matches that specified by the titrator.
- Turn on the titrator using the power switch located on the back of the instrument.
- Wait until the titrator finishes the initialization process.
- Press when prompted or wait a few seconds for titrator to start.

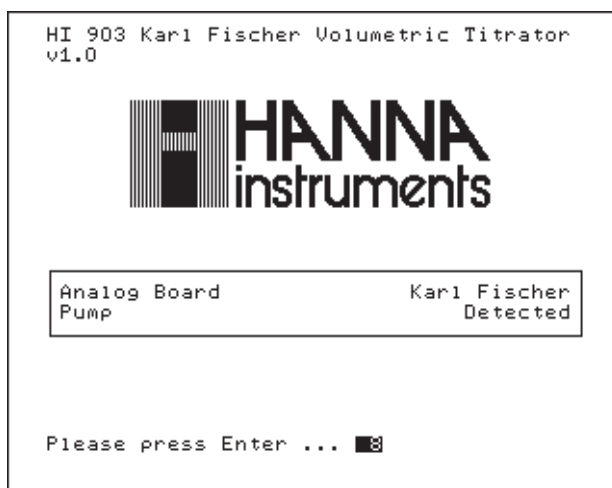

Note: All the performed initialization processes must be successfully completed. If one of them is terminated by a "Failed" message, restart the titrator using the power switch. If the problem persists, contact your dealer.

USER INTERFACE

3.2 Description

This chapter describes the basic principles of navigation through the user interface, selecting fields and entering values from the keypad.

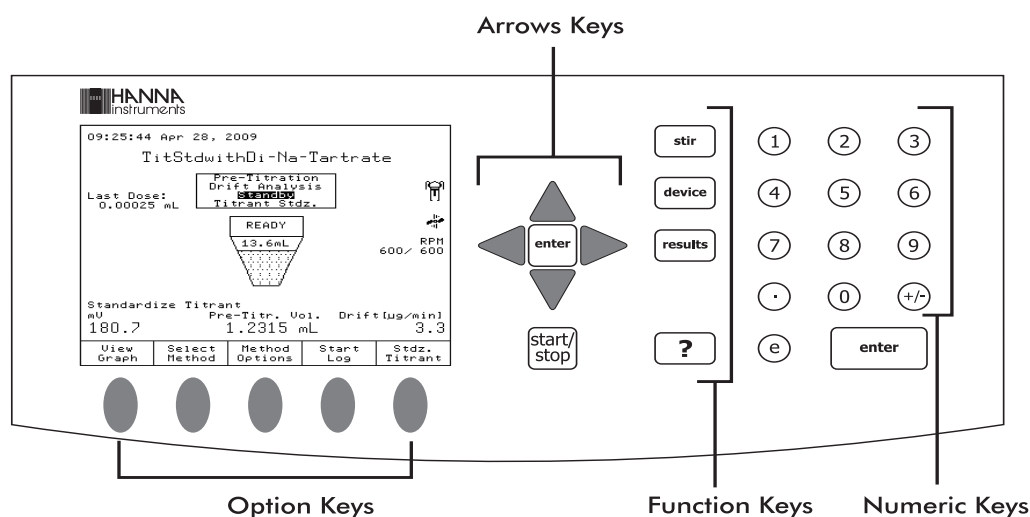

3.2.1 Keypad

The titrator's keypad is grouped into five categories, as follows:

3.2.1.1 Function Keys

If one of these keys is pressed, the associated function is immediately performed. Some of the keys are only active in specific screens:

	Starts or stops titration sequence
	Turns the stirrer ON and OFF (<i>Idle</i> mode only)
	Reserved
	Access the results menu
	Displays contextual Help

3.2.1.2 Option Keys

These keys are assigned to the virtual keys on the display. Their functions are listed in the boxes above the buttons and vary depending on the displayed screen.

An underlined virtual key can also be activated by pressing .

3.2.1.3 Arrow Keys

These keys have the following functions:

- Move the on-screen cursor.
- Increase and decrease the stirrer speed and other settings.
- In the alphanumeric screen, to select a character.
- To navigate through menu options.

3.2.1.4 Numeric Keys

- Keys **0** to **9** Used for numeric entries.
- +/-** Toggles between positive and negative values.
- .** Decimal point.
- e** Initiates entry of exponent for scientific notation.

3.2.1.5 Enter Key

Both **enter**, **enter** keys perform the same functions:

- Accepts alphanumeric data entry.
- Executes the default (underlined) virtual option key.

3.2.2 Display

The titrator has a large color graphical display. The standby mode screen is shown below with short explanations of the screen segments.

The user interface contains several screens for each titrator function.

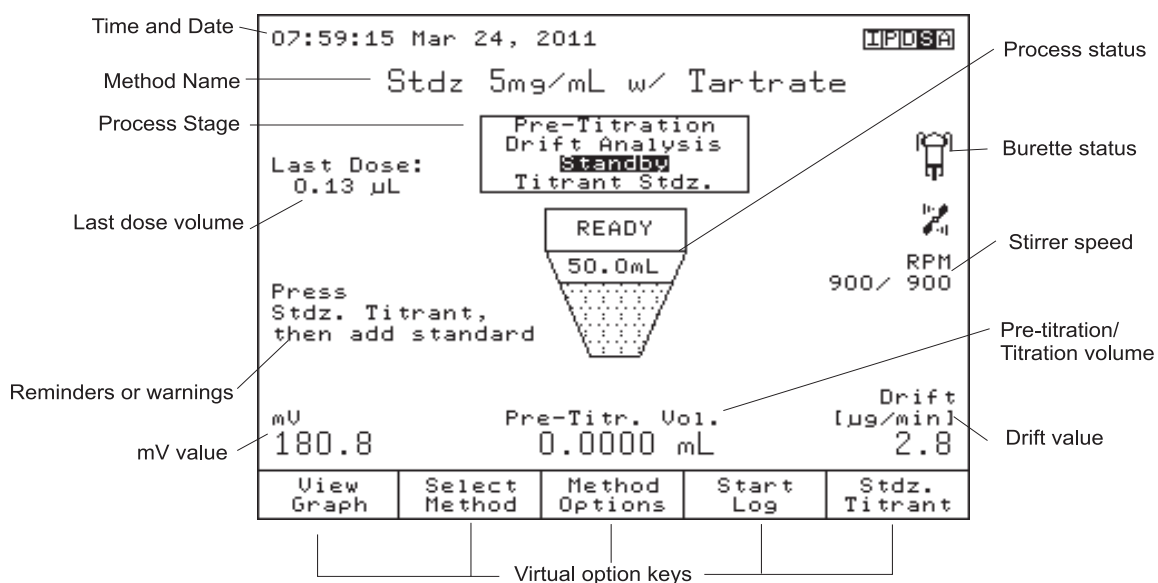

USER INTERFACE

3.2.3 The Idle Screen

After start up and initialization, the first screen displayed is the *Idle Screen*.

13:47:02 Apr 29, 2010				
Water in Butter				
Titrant: Composite 5				
Last Standardization: Apr 29, 2010 13:45				
General Options	Select Method	Method Options	Burette	Start Air Pump

Idle Screen fields:

Method name:	Displays the name of the selected method.
Time and date:	Displays the current date and time.
Stirrer information:	Actual / Set stirrer speed is displayed in RPM. When stirrer is off, the stirrer information is not displayed.
Titrant:	Displays the name of the current titrant.
Last Standardization:	Displays the titrant standardization date / time.
Reminders:	Indicates when a task needs to be performed and displays error or warning messages.

3.2.4 The Process Screen

When the user presses  while in *Idle Screen*, all titration related processes are started. The titrator displays the *Process Screen*.

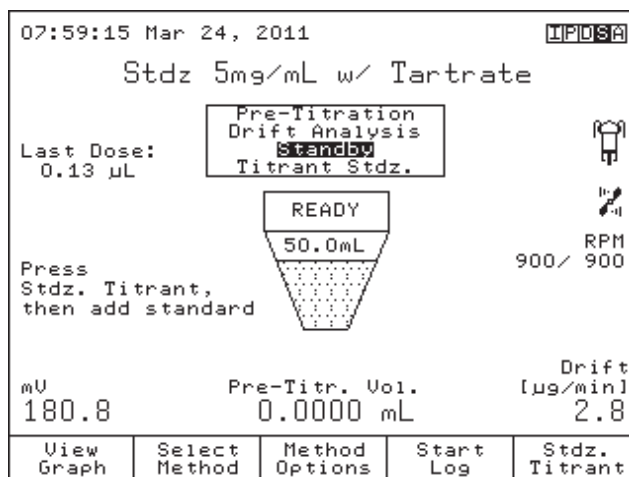

Process Screen fields:

Method name:	Displays the name of the selected method.
Time and date:	Displays the current date and time
Process stage field:	Displays the current process (Pre-titration, Drift Analysis, Standby, Sample Analysis / Titrant Standardization).
Process status:	Displays the process status with a descriptive drawing.
mV reading:	Displays the KF electrode potential.
Dispensed titrant:	Displays the total volume of dispensed titrant.
Last dose:	Displays the last titrant dose volume.
Drift value:	Displays the drift value (when available).
Stirrer information:	Actual / Set stirrer speed is displayed in RPM.
Burette status:	A descriptive drawing is displayed indicating the burette is active and cannot be removed.
Reminders:	Indicates when a task needs to be performed and displays error or warning messages.

USER INTERFACE

3.3 Menu navigation

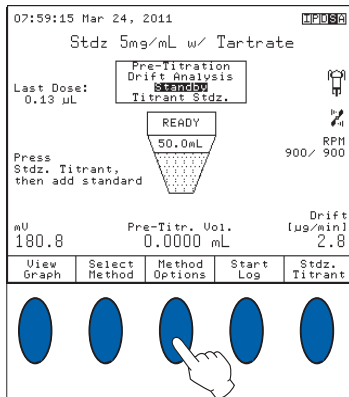

3.3.1 Selecting an Option

To select an option, simply press the option key below the virtual key. For example, to access the **Method Options** screen press the option key below it.

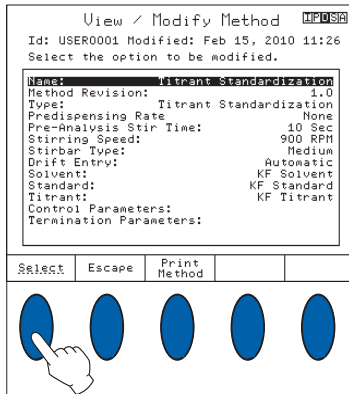

3.3.2 Selecting a Menu Item

To select an item from the menu screen use the arrow keys \triangle and ∇ to move the cursor.

When the menu is larger than the display, a scroll bar is active on the right side. The $\boxed{\text{Page Up}}$ and $\boxed{\text{Page Down}}$ keys can be used to scroll through the pages.

To activate the selected menu item, press $\boxed{\text{enter}}$ or $\boxed{\text{Select}}$.

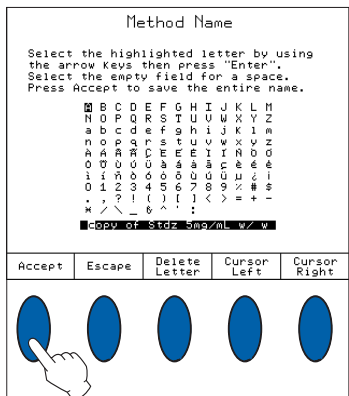

3.3.3 Entering Text

To enter text in an alphanumeric input box, first erase the previous text by using $\boxed{\text{Delete Letter}}$.

To enter a letter, highlight it using the arrow keys then press $\boxed{\text{enter}}$. Use the same procedure to enter the whole name.

For editing, use the $\boxed{\text{Cursor Left}}$ and $\boxed{\text{Cursor Right}}$ keys.

When editing is complete, press $\boxed{\text{Accept}}$.

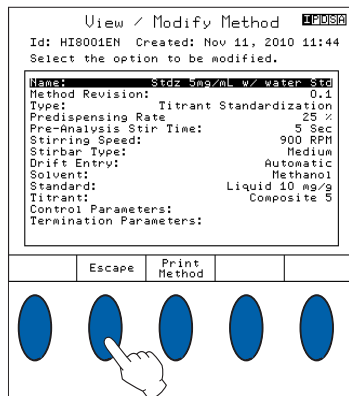

The method name will be updated and displayed in the name field of the **View/Modify Method** screen.

When all the desired parameters have been set, press

$\boxed{\text{Escape}}$.

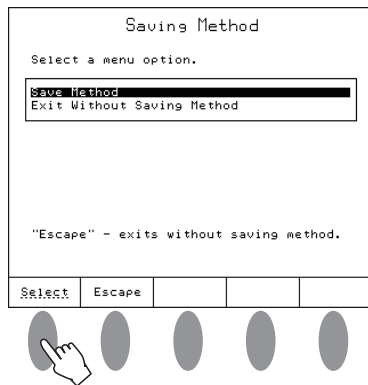

3.3.4 Saving Modifications

The **Saving Method** screen allows the user to save the modifications. To exit from **Saving Method** screen without saving, press or highlight the *Exit Without Saving Method* option and then press . To save the modifications highlight the *Save Method* option and then press .

Note: To access the contextual help menu, press at any time. Help is related to the displayed screen. Press or press again to return to the previous screen.

Chapter 4. Contents

4	GENERAL OPTIONS	4 - 3
4.1	Date and Time Setting	4 - 3
4.2	Display Settings	4 - 4
4.3	Beeper	4 - 5
4.4	Stirrer	4 - 5
4.5	Language	4 - 6
4.6	Estimated Cell Volume	4 - 6
4.7	Titration Database	4 - 6
4.8	Standard Database	4 - 7
4.9	Save Files to USB Storage Device	4 - 7
4.10	Restore Files from USB Storage Device	4 - 9
4.11	USB Link with PC	4 - 10
4.12	Calibration Check	4 - 10
4.13	Setup Balance Interface	4 - 11
4.14	Printer Mode	4 - 12
4.15	Reset to Default Settings	4 - 13
4.16	Update Software	4 - 13

4 GENERAL OPTIONS

The **General Options** screen gives access to options that are not directly related to the titration process. To access this screen, press General Options from the main screen while in idle mode. In Pre-titration, Drift Analysis, Standby or Titration process, the General Options can be accessed by pressing the <<Home>> key on a PS/2 keyboard.

The available menus are described below:

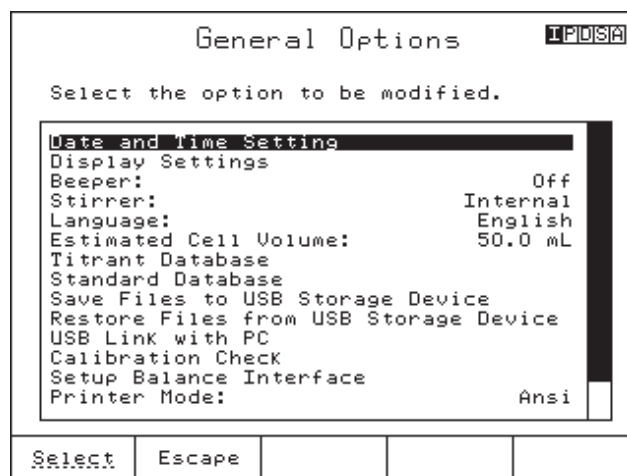

4.1 Date and Time Setting

This screen allows the user to set the date and time.

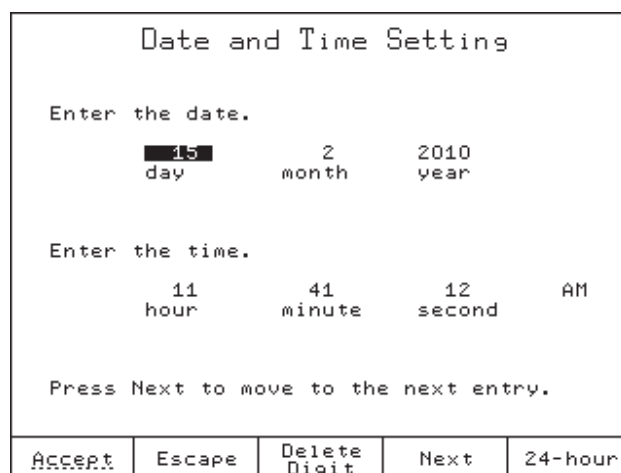

Use the ▲ and ▼ keys or the numeric keys to modify the date and time.

Press Next to move the cursor to the next field.

Press AM / PM or 24-hour to change the time format.

GENERAL OPTIONS

4.2 Display Settings

This screen allows the user to customize the viewing features of the display.

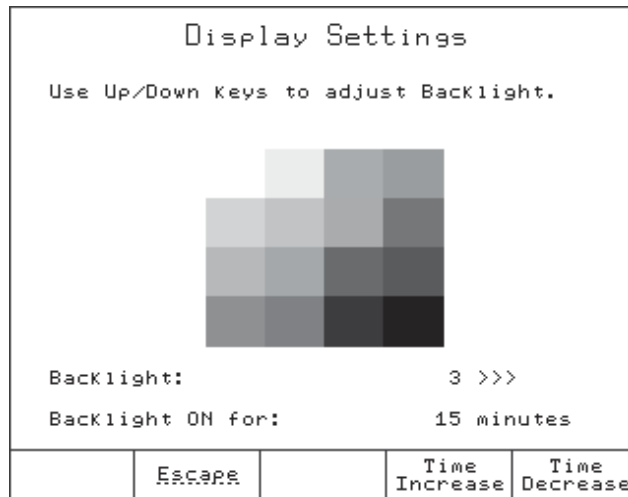

Option Keys:



Increases the backlight saver time interval

Decreases the backlight saver time interval

The backlight intensity can be adjusted using the \triangle and ∇ keys.

There are 8 levels of backlight intensity, ranging from 0 to 7.

A color palette is displayed in the center of the screen, allowing an easy selection of the appropriate backlight intensity.

The backlight saver option protects the display during standby periods, when no keys have been pressed for a set amount of time.

If the backlight is off, any keystroke will re-activate the backlight without performing any action.

The range for backlight saver interval is between 1 and 60 minutes. To disable the backlight saver increase the time to the maximum allowed. The "Off" indication will appear.

4.3 Beeper

This screen allows the user to turn the Beeper On (*Enable*) or Off (*Disable*).

```
Beeper
Select the option.
Beeper Off
Beeper On
Select  Escape  [ ]  [ ]  [ ]
```

The beeper will sound after a titration is completed, when an invalid key is pressed or when a critical error occurs during titration.

4.4 Stirrer

This screen allows the user to select the internal magnetic stirrer, an external magnetic stirrer or a user-controlled stirrer uncontrolled by the titrator (custom).

```
Stirrer
Select the option.
Internal
External
Custom
Select  Escape  [ ]  [ ]  [ ]
```

The external stirrer is automatically detected when it is connected.

Note: When the external stirrer is not connected the  key is not available for the "External" stirrer option.

GENERAL OPTIONS

4.5 Language

Select an available language.

Set Language				
Select the language.				
English Español Portuguese				
Select	Escape			

4.6 Estimated Cell Volume

This screen allows the user to enter the estimated volume of solution in the titration beaker.

Estimated Cell Volume				
Enter the estimated cell volume.				
45.7 mL				
Low Limit: 0.0 mL High Limit: 200.0 mL				
Accept	Escape	Delete Digit		

4.7 Titrant Database

This screen allows the user to store information about all of the titrants available for use, including the titrant name and Standardization information.

The titrant for the currently-selected method cannot be modified from this screen. For details on the full functionality of the database, see section 5.5.12

Titrant Database				
Select the KF titrant to be modified.				
<div style="border: 1px solid black; padding: 2px;"> Composite 5 Composite 2 Composite 1 </div>				
Titrant Type: One-component Nominal Titrant Conc.: 5.0000 mg/mL Standardized Titrant Conc.: 5.0000 mg/mL Date/Time: Jan 01, 2011 00:00 Titrant Age Reminder: Disabled				
	Escape	Edit	New Titrant	Delete

4.8 Standard Database

This screen allows the user to store information about all of the standards available for use, including the standard name and concentration.

The standard for the currently-selected method can not be modified from this screen. For details on the full functionality of the database, see section 5.5.11.

Standard Database				
Select the KF standard to be modified.				
<div style="border: 1px solid black; padding: 2px;"> Liquid 10 mg/g </div>				
Water Content: 10.0000 Concentration Unit: mg/g Type: Liquid by mass Standard Density: 1.000 g/mL				
	Escape	Edit	New Standard	

4.9 Save Files to USB Storage Device

This option allows the user to save files from titrator to a USB storage device.

On the titrator, the available file types are:

- Standard Method Files - **HIxxxxyy.MTD** (e.g.: HI8001EN.MTD, HI8101EN.MTD)
- User Method Files - **USERxxxx.MTD** (e.g.: USER0001.MTD)
- Drift/Titration Report Files - **DR_xxxxx.RPT, KF_xxxxx.RPT**
(e.g.: DR_00001.RPT, KF_00001.RPT)

GENERAL OPTIONS

Insert the USB Storage Device into the USB port on the left side of the titrator.

Use the ◀ and ▶ keys to switch between the 3 file types. The number of files and each file name on the titrator will be displayed.

Use the ▲ and ▼ keys to scroll through the list.

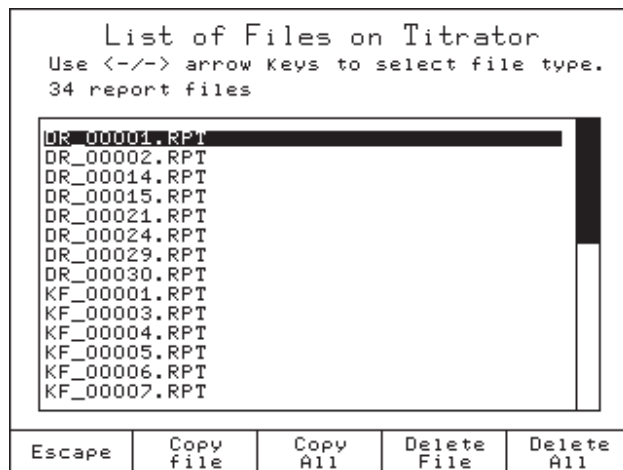

The option keys allow the following operations:

Escape	Returns to the General Options screen
Copy File	Copies the highlighted file from titrator to a USB storage device
Copy All	Copies all currently displayed files from titrator to a USB storage device
Delete File	Deletes the highlighted file.
Delete All	Deletes all currently displayed files.

The status of the transfer ("successful" / "unsuccessful") and the file name of the currently processed file are displayed during copying or deleting.

Note: The saved files will be stored on the USB Key in the HI 903 folder, as follows:

- Methods: USB Drive: \ HI 903 \ Methods \ *.mtd
- Reports: USB Drive: \ HI 903 \ Reports \ *.rpt

4.10 Restore Files from USB Storage Device

This screen allows the user to transfer files from the USB storage device to the titrator. Insert the USB Storage Device into the USB port on the left side of the titrator.

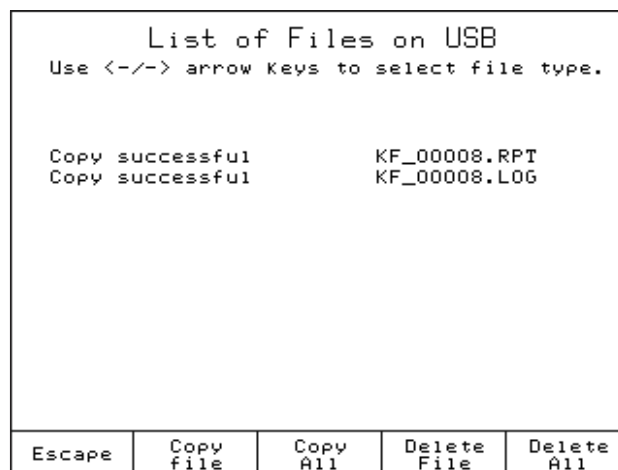
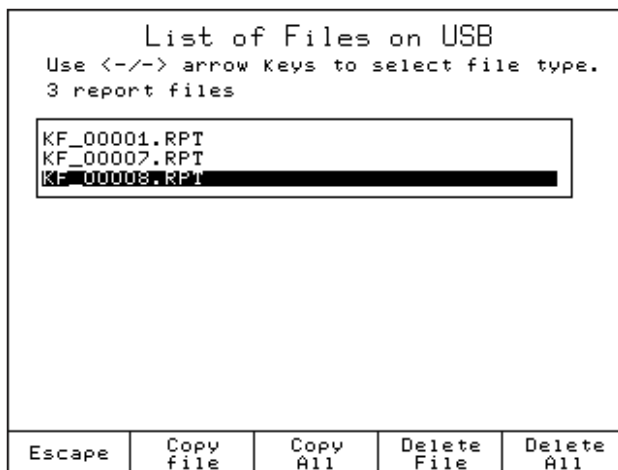

The file types that can be transferred are:

- Standard Method Files - **HIxxxxyy.MTD** (e.g.: HI8001EN.MTD, HI8101EN.MTD)
- User Method Files - **USERxxxx.MTD** (e.g.: USER0001.MTD)
- Drift/Titration Report Files - **DR_xxxxx.RPT, KF_xxxxx.RPT**
(e.g.: DR_00001.RPT, KF_00001.RPT)

Use the ◀ and ▶ keys to select the file type.

Use the ▲ and ▼ keys to scroll through the list.

The number of files and the name of each file found on the USB storage device is displayed on the screen.

The option keys allow the following operations:

- Escape Returns to the **General Options** screen.
- Copy File Copies the highlighted file from the USB storage device to titrator.
- Copy All Copies all currently displayed files from the USB storage device to titrator.
- Delete File Deletes the highlighted file from the USB storage device.
- Delete All Deletes all currently displayed files from the USB storage device.

Note: In order to restore files from USB Key, please ensure that the methods and/or reports you wish to transfer to the titrator are in the correct folder:

- Methods: USB: \ Drive \ HI 903 \ Methods \ *.mtd
- Reports: USB: \ Drive \ HI 903 \ Reports \ *.rpt

GENERAL OPTIONS

4.11 USB Link with PC

The USB Link feature is useful to transfer methods/reports directly to/from a PC. To use this feature, connect the USB cable to the labeled connector on rear of titrator and connect to a PC with HI900PC Application installed. The titrator automatically attempts to connect to the PC while on this screen.

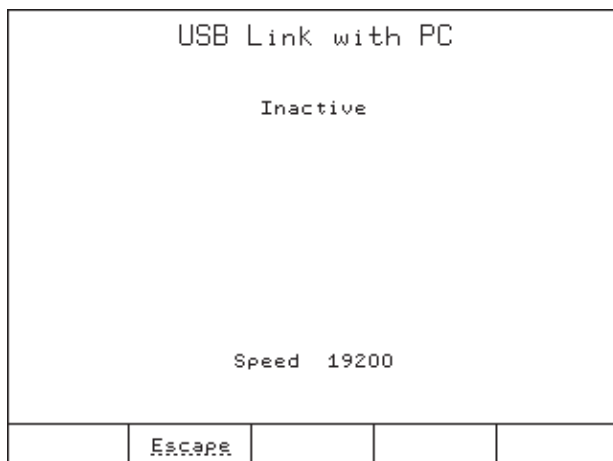

Inactive: The titrator is not connected to the HI 900 PC Application.

Active: The titrator is connected to the HI 900 PC Application.

Ready: The titrator is ready for commands.

Transmit: It shows the progress of the current transfer.

Speed: It shows the baud rate for the communications port.

4.12 Calibration Check

This screen allows the user to verify the analog board calibration.

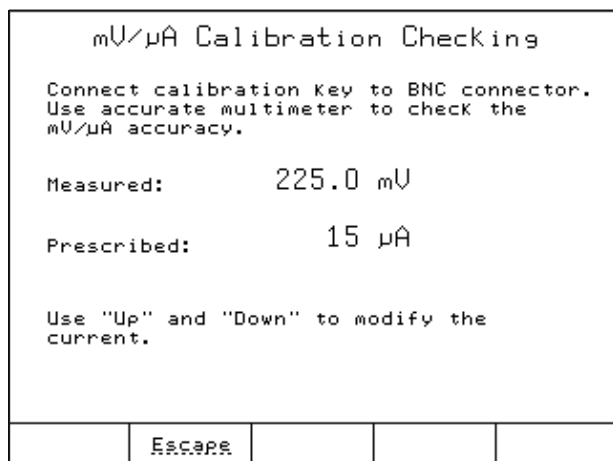

Two parameters can be verified, the *electrode mV input* and the *electrode polarization current*. Both parameters can be measured on the same BNC connector using the calibration key and a mV/μA multimeter (not included).

Disconnect the KF electrode, then connect the HI900941 calibration key to the electrode input (BNC connector).

Depending on which parameters you want to check, follow the indications below:

Checking the mV input accuracy:

Set the multimeter to mV mode.

If necessary, switch the calibration key to mV mode by pressing the red button.

Connect the calibration key banana plugs to the multimeter mV input.

Choose the current value using the \triangle and ∇ keys (from the pre-defined list).

Check if the millivolts indication is in accordance with the value displayed on the titrator screen (within 2% accuracy).

Checking the μ A output accuracy:

Set the multimeter to μ A mode.

If necessary, switch the calibration key to μ A mode by pressing the red button.

Connect the calibration key banana plugs to the multimeter mA input.

Check for the multimeter indication to be in accordance with the titrator μ A prescribed value.

4.13 Setup Balance Interface

This screen allows the user to setup an analytical balance for automatic acquisition of sample mass prior to titration or standardization.

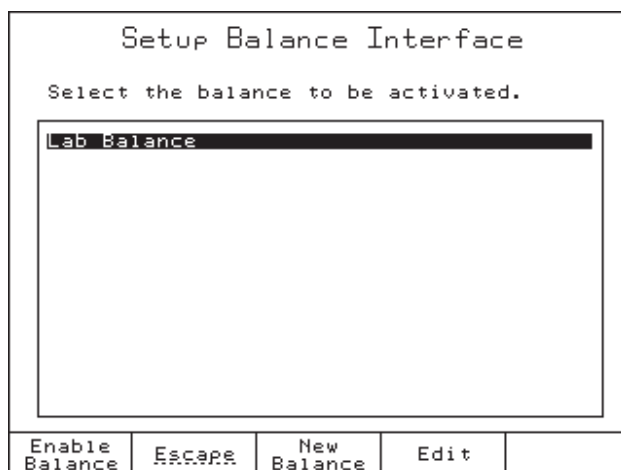

The balance is connected to the titrator via RS 232 interface.

Press to add a new balance to the list.

Press to enable the balance interface feature.

Press to disable the balance feature (automatic mass acquisition will not be available).

Press to customize the serial communication parameters. The **Balance Configuration** screen will open.

Press to remove the highlighted balance. Note: At least one balance must be in the list.

GENERAL OPTIONS

Configure the settings on the titrator *Balance Configuration* menu to match the settings for your particular balance (baud rate, data bits, parity, stop bit number, request command syntax). It may be necessary to change settings on your balance. Users should consult their balance instruction manual.

Before leaving this screen be sure the connection with the balance is working properly by pressing the Test Balance key.

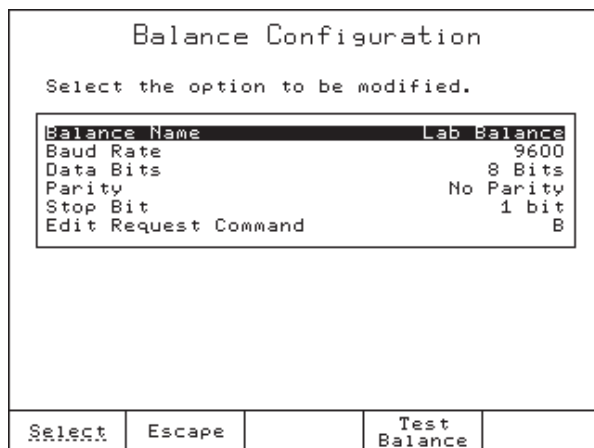

4.14 Printer mode

This screen allows the user to select the printing mode: ANSI (default), ASCII and Text mode.

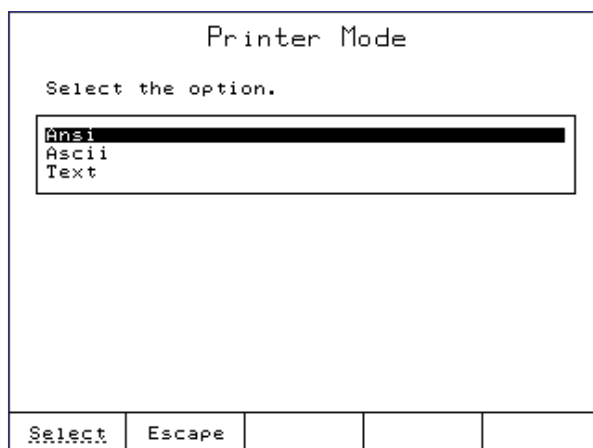

ANSI mode:

Use this mode when your printer is set to ANSI. In this case all accepted characters / symbols available on the titrator will be printed by your printer.

ASCII mode:

Use this mode when your printer is set to ASCII. In this case only some of the accented characters / symbols available on the titrator will print.

Text mode:

Use this when you don't need to print the accented characters.

4.15 Reset to Default Settings

This option restores the manufacturer settings.

Note: Please be careful!!! This will also delete all the user created methods, reports and restore all manufacturer settings such as titrator configuration, standard method parameters, etc.

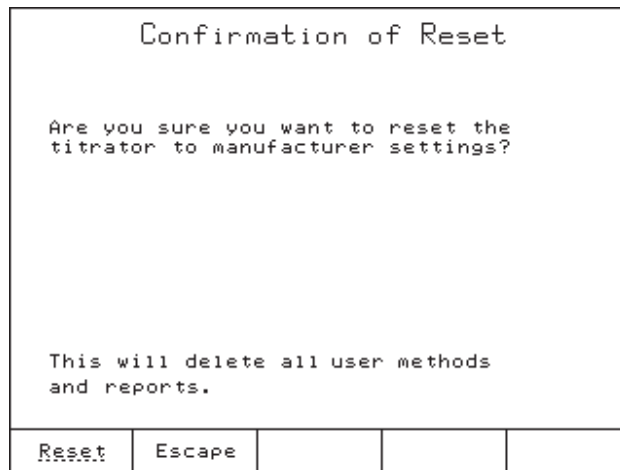

4.16 Update Software

This screen allows the user to update the titrator software from a USB storage device containing a software setup kit.

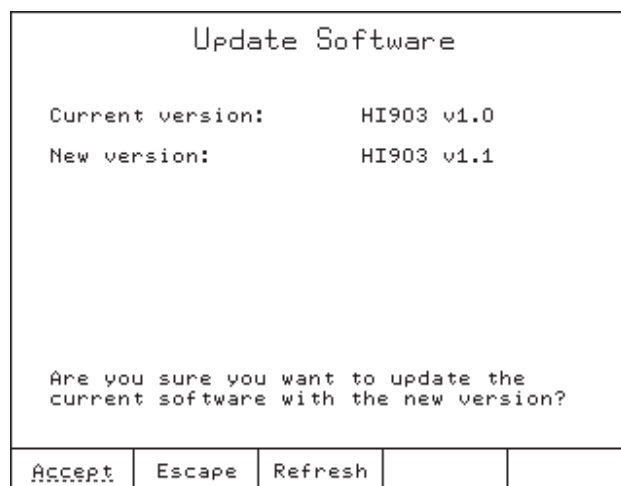

Chapter 5. Contents

5	METHODS	5 - 3
5.1	Selecting Methods	5 - 3
5.2	Standard Methods	5 - 4
5.2.1	Upgrading Standard Methods	5 - 4
5.2.2	Deleting Standard Methods	5 - 4
5.2.3	Restoring the Standard Methods to the Manufacturer's Settings	5 - 5
5.3	User Methods	5 - 5
5.3.1	Creating User Methods	5 - 5
5.3.2	Deleting User Methods	5 - 6
5.4	View / Modify Method	5 - 6
5.5	Method Options	5 - 7
5.5.1	Naming the User Method	5 - 7
5.5.2	Method Revision	5 - 8
5.5.3	Method Type	5 - 8
5.5.4	Predispensing Amount	5 - 9
5.5.5	Pre-Analysis Stir Time	5 - 9
5.5.6	Stirring Speed	5 - 10
5.5.7	Stirbar Type	5 - 10
5.5.8	Drift Entry	5 - 11
5.5.9	Solvent Name	5 - 12
5.5.10	Sample Parameters (<i>Sample Analysis</i> mode only)	5 - 12
5.5.10.1	Sample Determination	5 - 13
5.5.10.2	Sample Name	5 - 13
5.5.10.3	Sample Type	5 - 14
5.5.10.4	Sample Size	5 - 14
5.5.11	Standard (<i>Titrant Standardization</i> mode only)	5 - 15
5.5.11.1	Standard Name	5 - 15
5.5.11.2	Standard Type	5 - 15

METHODS

5.5.11.3 Concentration Unit	5 - 16
5.5.11.4 Water Content	5 - 16
5.5.11.5 Standard Size	5 - 16
5.5.12 Titrant	5 - 16
5.5.12.1 Titrant Name	5 - 17
5.5.12.2 Titrant Type.....	5 - 17
5.5.12.3 Nominal Titrant Concentration	5 - 18
5.5.12.4 Standardized Titrant Concentration	5 - 18
5.5.12.5 Titrant Age Reminder.....	5 - 18
5.5.13 Control Parameters	5 - 19
5.5.13.1 Start Mode.....	5 - 19
5.5.13.2 Standby Mode	5 - 20
5.5.13.3 Standby Duration	5 - 20
5.5.13.4 Imposed Current	5 - 21
5.5.13.5 Dosing Parameters	5 - 21
5.5.13.6 Timed Increment	5 - 22
5.5.13.7 End Point Value.....	5 - 22
5.5.13.8 Signal Averaging	5 - 23
5.5.13.9 Flow Rate.....	5 - 23
5.5.14 Termination Parameters	5 - 24
5.5.14.1 Maximum Duration	5 - 24
5.5.14.2 Maximum Titrant Volume	5 - 25
5.5.14.3 Termination Criterion	5 - 25
5.5.14.4 EndPoint Stability Time	5 - 26
5.5.15 Result Unit	5 - 26
5.6 Printing	5 - 26

5 METHODS

All of the parameters required to complete an analysis are grouped into a method. The titrator is supplied with a pack of standard methods. Standard and user methods can be upgraded, stored or deleted by connecting the titrator to a PC using the HI900PC application or a USB storage device.

5.1 Selecting Methods

To select a method, press the  key (when available). A list of available methods will be displayed.

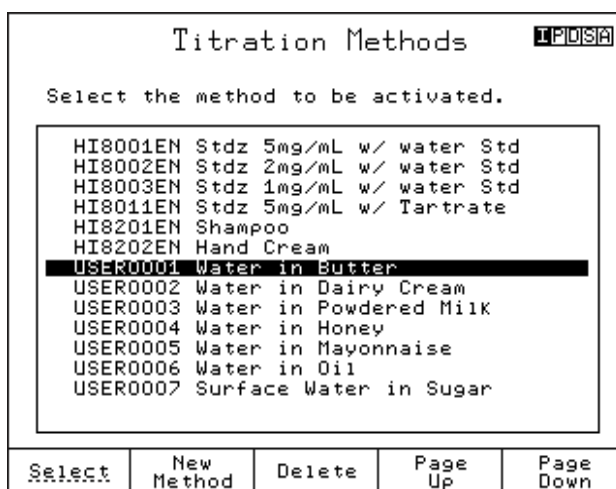

In the **Titration Methods** screen, you can view the list of all available methods (standard and user methods, if available).

To select a method, highlight the method and press . The name of the selected method will be displayed on the screen.

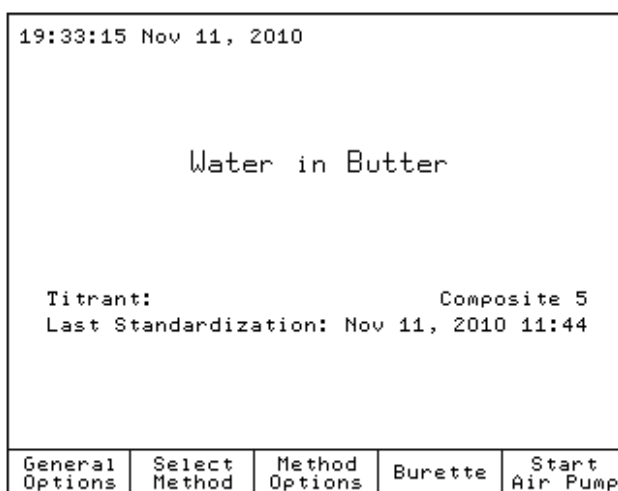

METHODS

5.2 Standard Methods









The standard methods were developed for the most common types of analysis. Also, the standard methods can be used as a model to create new user methods.

Only specific method parameters can be modified by the user (see Section 5.5, *Method Options* section).

5.2.1 Upgrading Standard Methods

To upgrade the titrator with new standard methods, follow the steps below:

From USB Storage Device:

- Insert the USB storage device into the USB port, located on the left side of the titrator.
- Access the **General Options** screen.
- Using the  and  keys, highlight the *Restore Files from USB Storage Device* option and choose .
- Using the  and  keys, navigate through file types to find “standard method files”. The list with available standard methods on the storage device will be displayed.
- Press the  or  key to upgrade the titrator with the standard methods.
- Press  to return to **General Options** screen.

Note: See section 4.8 *Restore Files from USB Storage Device*.









From PC:

You can upgrade the titrator with standard methods from a PC using the HI 900 PC application (see Section 4.9, *USB Link with PC*).

5.2.2 Deleting Standard Methods

Unnecessary standard methods can be removed from titrator by following the procedure below:

From **General Options** screen:

- Access the **General Options** screen.
- Using the  and  keys, highlight the *Save Files to USB Storage Device* option and press .
- Using the  and  keys, navigate through the file types to find “standard method files”. The available standard methods will be displayed.
- Press the  or  keys to remove unnecessary standard methods.
- Press  to return to the **General Options** screen.

From PC:

Unnecessary Standard Methods can be removed from the titrator using the HI 900 PC application (see Section 4.9, *USB Link with PC*).

5.2.3 Restoring the Standard Methods to the Manufacturer Settings

You can restore the standard method to the manufacturer setting by highlighting a standard method and pressing .





<p style="text-align: center;">Titration Methods LIPDUSA</p> <p>Select the method to be activated.</p> <div style="border: 1px solid black; padding: 5px;"> <p>HI8001EN Stdz 5mg/mL w/ water Std HI8002EN Stdz 2mg/mL w/ water Std HI8003EN Stdz 1mg/mL w/ water Std HI8011EN Stdz 5mg/mL w/ Tartrate HI8201EN Shampoo HI8202EN Hand Cream USER0001 Water in Butter USER0002 Water in Dairy Cream USER0003 Water in Powdered Milk USER0004 Water in Honey USER0005 Water in Mayonnaise USER0006 Water in Oil USER0007 Surface Water in Sugar</p> </div>					<p style="text-align: center;">Confirmation of Reset Method</p> <p style="text-align: center;">Are you sure you want to reset selected method to default?</p>				
Select	New Method	Reset to Default	Page Up	Page Down	Reset	Escape			

5.3 User Methods

These methods are defined by the user (usually by modifying a standard method). The user methods can be developed in accordance with the requirements of the user. All method parameters can be modified by the user.

5.3.1 Creating User Methods

To create a new user method start from a standard or user method, and follow these steps:

- Press  from the main screen.
- Using the  and  keys, highlight an existing method from the methods list.
- Press . A new user method will be generated.
- Press  to activate the new created user method.

<p style="text-align: center;">Titration Methods LIPDUSA</p> <p>Select the method to be activated.</p> <div style="border: 1px solid black; padding: 5px;"> <p>HI8001EN Stdz 5mg/mL w/ water Std HI8002EN Stdz 2mg/mL w/ water Std HI8003EN Stdz 1mg/mL w/ water Std HI8011EN Stdz 5mg/mL w/ Tartrate HI8201EN Shampoo HI8202EN Hand Cream USER0001 Water in Butter USER0002 Water in Dairy Cream USER0003 Water in Powdered Milk USER0004 Water in Honey USER0005 Water in Mayonnaise USER0006 Water in Oil USER0007 Surface Water in Sugar USER0008 copy of Shampoo</p> </div>					<p>19:34:26 Nov 11, 2010</p> <p style="text-align: center;">copy of Shampoo</p> <p>Titrant: Composite 5 Last Standardization: Nov 11, 2010 11:44</p>				
Select	New Method	Delete	Page Up	Page Down	General Options	Select Method	Method Options	Burette	Start Air Pump

METHODS

Note: Only a limited number of user methods can be generated. The titrator can hold 100 methods (standard and user). When it is reached, a warning message will be displayed.

5.3.2 Deleting User Methods

To remove a user method, press **Select Method** (when available). Highlight the user method that you want to delete and press **Delete**. A screen will appear in order to confirm the deletion. Press **Delete** again to confirm, or press **Escape** to cancel the operation.

Confirmation of Method Deletion				
Are you sure you want to delete the selected method?				
copy of Water in Butter				
Delete	Escape			

5.4 View / Modify Method

To modify the method's parameters, press **Method Options** from the main screen. A list of all the parameters for the selected method will be displayed. Press the **△** and **▽** keys to highlight the option that you want to modify and choose **Select**.

View / Modify Method IPUSA				
Id: USER0001 Modified: Feb 01, 2011 09:05				
Select the option to be modified.				
Name: copy of Moisture in Sham				
Method Revision: 1.0				
Type: Sample Analysis				
Predispensing Amount: 40 %				
Pre-Analysis Stir Time: 15 Sec				
Stirring Speed: 900 RPM				
Stirbar Type: Medium				
Drift Entry: Automatic				
Solvent: Methanol				
Sample Parameters:				
Titrant: Composite 5				
Control Parameters:				
Termination Parameters:				
Result Unit: %				
Select	Escape	Print Method		

Save method:

After making modifications highlight **Save Method** and press

After making modifications, press and select **Save Method** to keep the changes.

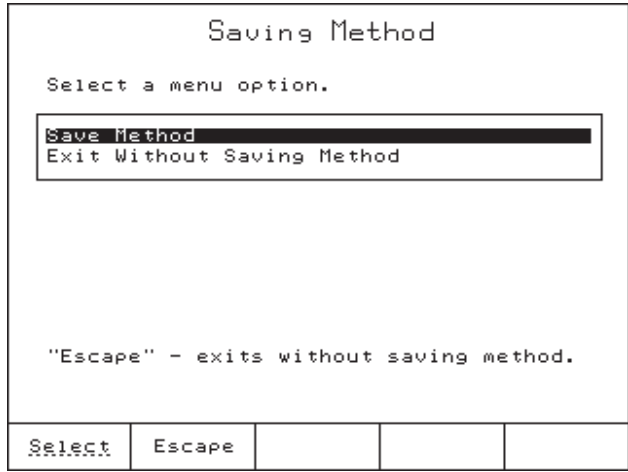

5.5 Method Options

5.5.1 Naming the User Method

This option allows you to enter a name for the new method (up to 24 characters). Use the arrow keys to navigate through the character table. Press to add the highlighted character to the method name.

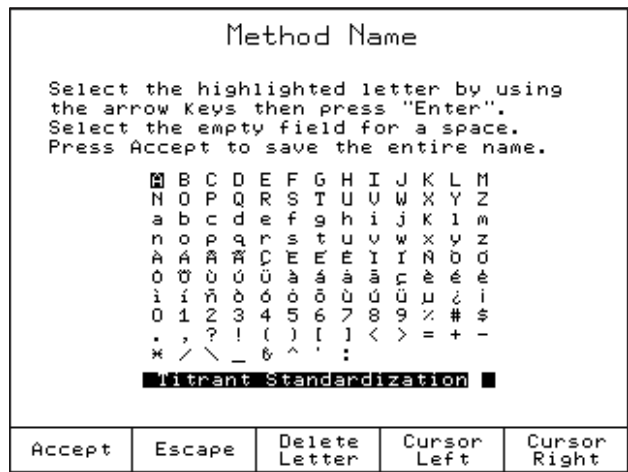

METHODS

5.5.2 Method Revision

This option allows you to enter a string representing the current method revision. The revision string format should be "X.Y", where X and Y are numerical digits.

Method Revision				
Select the highlighted letter by using the arrow keys then press "Enter". Select the empty field for a space. The revision string format is "X.X".				
☐	B	C	D	E
N	O	P	Q	R
a	b	c	d	e
n	o	p	q	r
À	Á	Â	Ã	Ä
Ò	Ó	Ô	Õ	Ö
ì	í	î	ï	ò
0	1	2	3	4
.	,	?	!	(
*	/	\	-	^
				1.0
Accept	Escape	Delete Letter	Cursor Left	Cursor Right

5.5.3 Method Type

Method type is a parameter listed in each method.

In order to conduct a titration the user has to choose between water determination in the sample (Sample Analysis) or determination of titrant concentration (Titrant Standardization).

Method Type				
Choose the method application type.				
<input checked="" type="checkbox"/> Sample Analysis				
<input type="checkbox"/> Titrant Standardization				
Select	Escape			

5.5.4 Predispensing Amount

The titration time can be shortened by adding a large fraction of the titrant at the start of the analysis, if the approximate water content of the sample is known.

Predispensing Amount				
Enter the percentage of titrant volume that will be predispensed.				
██████████ 40 %				
Low Limit: 0 %				
High Limit: 90 %				
ACCEPT	Escape	Delete Digit		

The predispensing amount can be set to deliver between 1 and 90% of the titrant required to reach the end point.

Setting the amount to 0% will disable the titrant predispensing feature.

5.5.5 Pre-Analysis Stir Time

To avoid erroneous results or unreachabe endpoints when analyzing samples with limited solubility, the sample must be completely dissolved in the solvent prior to the start of a titration.

The pre-analysis stir time can be set between 0 and 1000 seconds. After the sample is added to the reaction vessel the titrator will stir for the set period of time before any titrant (excluding predispensing) is added to the cell.

Pre-Analysis Stir Time				
Enter the initial mixing time prior to the start of the titration.				
██████████ 10 seconds				
Low Limit: 0 seconds				
High Limit: 1000 seconds				
ACCEPT	Escape	Delete Digit		

METHODS

5.5.6 Stirring Speed

Stirring Speed				
Enter the speed of the stirrer during the titration.				
500 RPM				
Low Limit: 200 RPM High Limit: 2000 RPM				
ACCEPT	Escape	Delete Digit		

The stirring speed can be set between 200 and 2000 RPM with a resolution of 100 RPM. The stirrer will remain on, as long as the method is active. The speed can be adjusted at any time by using the \triangle and ∇ keys when the stirrer is running.

5.5.7 Stirbar Type

Allows the user to edit the stirbar description.

Stirbar Type				
Select the highlighted letter by using the arrow keys then press "Enter". Select the empty field for a space. Press Accept to save the stirrbar type.				
B C D E F G H I J K L M N O P Q R S T U V W X Y Z a b c d e f g h i j k l m n o p q r s t u v w x y z À Á Â Ã Ç È É I J K L M N O P Q R S T U V W X Y Z [\] ^ _ ` i j k l m n o p q r s t u v w x y z 0 1 2 3 4 5 6 7 8 9 % & # \$. , ? ! () [] < > = + - * / \ _ & ^ ' : Medium				
Accept	Escape	Delete Letter	Cursor Left	Cursor Right

5.5.8 Drift Entry

Allows the user to choose the drift entry mode that is used during the titration process:

Drift Entry				
Choose the drift entry mode.				
<input type="checkbox"/> Automatic				
<input type="checkbox"/> User				
Select	Escape			

Automatic - the drift rate will be calculated automatically after the Pre-titration of the solvent.
User - the drift is set to a fixed value (entered by the user). The user enters the estimated drift value. The drift analysis stage will be skipped and the user must enter the drift value between 0.0 µg/min and 10.0 µg/min.

User Drift Value				
Enter the background drift value for final result correction.				
<input type="text" value="8.0"/> µg/min				
Low Limit: 0.0 µg/min				
High Limit: 10.0 µg/min				
Accept	Escape	Delete Digit		

METHODS

5.5.9 Solvent Name

The user can enter a name for the solvent (up to 15 characters). Use the arrow keys to navigate through the character table. Press to add the highlighted character to the solvent name.

Solvent Name

Select the highlighted letter by using the arrow keys then press "Enter".
Select the empty field for a space.
Press Accept to save the entire name.

A	B	C	D	E	F	G	H	I	J	K	L	M
N	O	P	Q	R	S	T	U	V	W	X	Y	Z
a	b	c	d	e	f	g	h	i	j	k	l	m
n	o	p	q	r	s	t	u	v	w	x	y	z
À	Á	Â	Ã	Ä	Å	Æ	Ç	È	É	Ê	Ë	Ì
Í	Î	Ï	Ñ	Ò	Ó	Ô	Õ	Ö	Ù	Ú	Û	Ü
Ý	ÿ	0	1	2	3	4	5	6	7	8	9	X
#	\$.	,	?	!	()	[]	<	>	=
+	-	*	/	\	_	`	^	'	:			

Methanol

Accept	Escape	Delete Letter	Cursor Left	Cursor Right
--------	--------	---------------	-------------	--------------

5.5.10 Sample Parameters (Sample Analysis mode only)

This screen allows the user to access and configure the specific sample parameters.

Sample Parameters

Select the option to be modified.

Sample Determ.:	Normal
Sample Name:	Butter
Sample Type:	Mass
Sample Size:	0.5000 g

Select	Escape			
--------	--------	--	--	--

5.5.10.1 Sample Determination

This screen allows the user to select the sample determination mode.

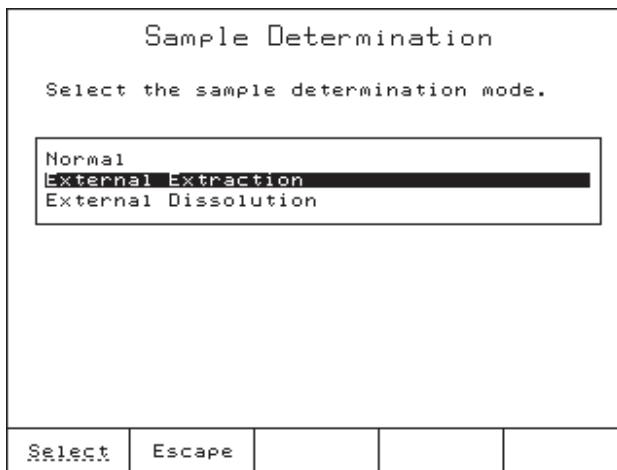

Normal sample determination is performed through direct titration of samples that are soluble in solvent or are finely divided and have homogeneous distribution in water.

External extraction is a method for the preparation of insoluble samples that require an external water extraction. Using the proper solvents the sample is broken down into a fine suspension from which, the water is extracted and released into the solvent.

External dissolution is a method for the preparation of the following types of samples:

- samples with a very high water content.
- samples that do not exhibit a homogeneous water distribution.
- slow-dissolving samples
- samples that can contaminate the titration vessel, thus reducing the accuracy, precision, number of titrations between solvent changes and raising the cell maintenance requirements.

5.5.10.2 Sample Name

This screen allows the user to enter a name for the sample (up to 14 characters). Use the arrow keys to navigate through the character table. Press to add the highlighted character to the sample name.

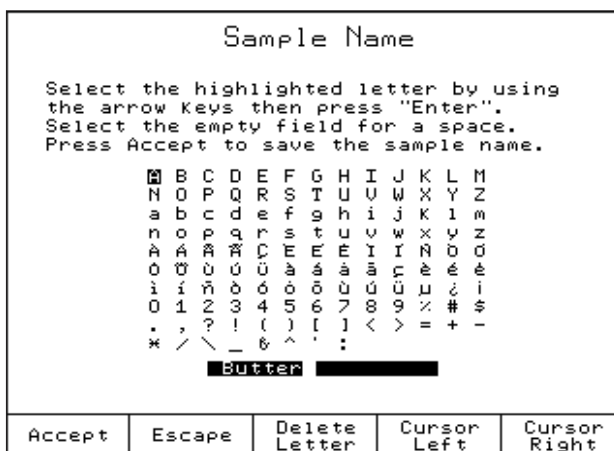

METHODS

5.5.10.3 Sample Type

This option allows the user to select the type of the sample: mass, volume or pieces.

Sample Type							
Choose the sample amount type.							
<table><tr><td style="background-color: black; color: white;">Mass</td></tr><tr><td>Volume</td></tr><tr><td>Pieces</td></tr></table>					Mass	Volume	Pieces
Mass							
Volume							
Pieces							
Select	Escape						

This information is used to determine the appropriate sample size required by the titration prior to analysis.

5.5.10.4 Sample Size

Sample Size						
Enter the sample size in current unit.						
<table><tr><td style="background-color: black; color: white;">0.5000</td><td>g</td></tr></table>					0.5000	g
0.5000	g					
Low Limit: 0.0010 g						
High Limit: 100.0000 g						
Accept	Escape	Delete Digit				

This option allows the user to enter the sample size. For external/Dissolution, enter the size of the aliquot taken from the external vessel.

Before the titration is started, the user is asked again to enter the sample size. The sample size (mass or volume) can be automatically acquired from the balance (when the balance feature is enabled - see Section 4.11, *Setup Balance Interface*)

5.5.10.5 External Solvent Size (External Dissolution/Extraction Determination Modes Only).

Enter the mass of the solvent used for external dissolution or extraction of the sample. Weigh the solvent after determining the solvent water content but before adding sample to the solvent

5.5.10.6 External Solvent Conc. (External Dissolution/Extraction Modes Only).

Enter the water content of the solvent used for extraction or dissolution.

5.5.10.7 Extracted Sample Size (External Extraction Determination Mode Only).

Enter the amount of sample added to the External Extraction vessel.

5.5.10.8 Dissoluted Sample Size (External Dissolution Determination Mode Only).

Enter the amount of sample added to the External Dissolution vessel.

Standard Database				
Select the KF standard to be modified.				
Liquid 10 mg/g				
Water Content: 10.0000 Concentration Unit: mg/g Type: Liquid by mass Standard Density: 1.000 g/mL				
Select	Escape	Edit	New Standard	

5.5.11 Standard (Titrant Standardization mode only)

This screen allows the user to define a list of Karl Fischer standards and customize related parameters.

Using the \triangle and ∇ keys, highlight the standard from the existing list and press to choose it.

Press if you want to create and add a new standard to the Karl Fischer standard data base.

Press if you want to remove a Karl Fischer standard from the pre-defined list.

Press if you want to edit the Karl Fischer standard parameters.

Hanna Standard Methods (Titrant standardizations only) are designed to be used with standards of specific types and water contents. The HI903 will automatically select an appropriate standard when such a method is selected. If there is no usable standard in the database, a new one will be created.

METHODS

5.5.11.1 Standard Name

This option allows the user to edit the name of the standard.

KF Standard Options	
Select the option to be modified.	
Name:	Liquid 10 mg/g
Type:	Liquid by mass
Concentration Unit:	mg/g
Water Content:	10.0000

Select	Escape			
--------	--------	--	--	--

5.5.11.2 Standard Type

The user can select the type of the standard: Mass or Volume.

5.5.11.3 Concentration Unit

The concentration unit can be selected: %[W/W], ppm, mg/g, mg/mL.

5.5.11.4 Water Content

The concentration of the standard can be entered (content of water in the selected unit).

5.5.12 Standard Size

Enter the amount of standard used during titrant standardization.

Before the titrant standardization is started, the user is asked again to enter the standard size. The standard size (mass and volume) can be acquired automatically from a compatible analytical balance (when the balance feature is enabled - see Section 4.11, *Setup Balance Interface*).

5.5.13 Titrant

The user can access the Karl Fischer titrant database and customize related parameters.

Using the \triangle and ∇ keys, highlight the titrant from the existing list and press Select to choose it.

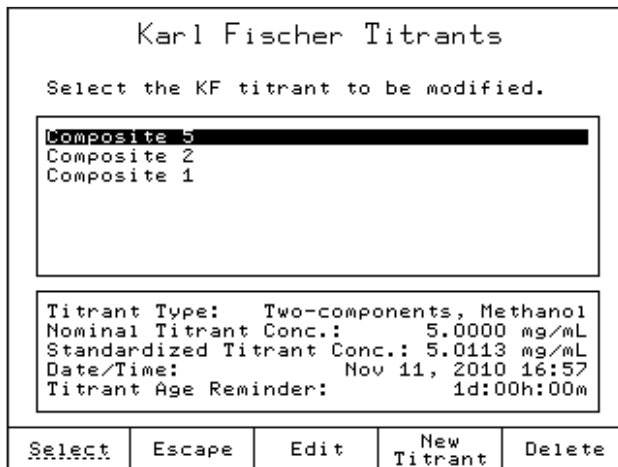

Press New Titrant to create a new titrant.

Press Delete to remove the titrant from the list.

Press Edit to edit the titrant parameters.

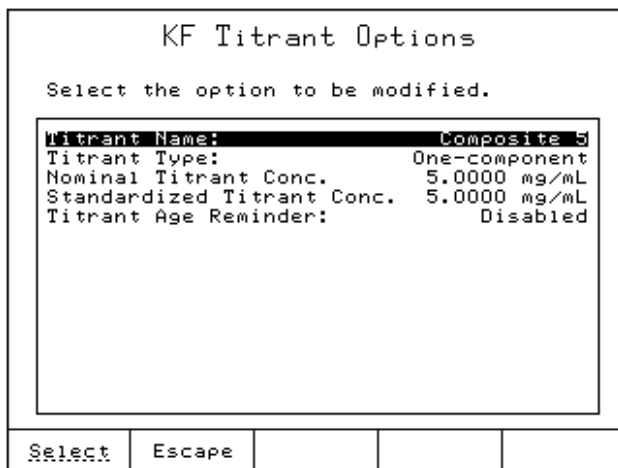

Hanna Standard Methods are designed to be used with titrants of specific types and concentrations. The HI903 will automatically select an appropriate titrant when such a method is selected. If there is no usable titrant in the database, a new one will be created.

METHODS

5.5.13.1 Titrant Name

The user can edit the name for the titrant.

5.5.13.2 Titrant Type

The user can select the type of titrant.

Titrant Name					Titrant Type				
Select the highlighted letter by using the arrow keys then press "Enter". Select the empty field for a space. Press Accept to save the entire name.					Select the Karl Fischer titrant type.				
M B C D E F G H I J K L M N O P Q R S T U V W X Y Z a b c d e f g h i j k l m n o p q r s t u v w x y z À Á Â Ã Ä Å Æ Ç È É Ê Ë Ì Í Î Ï Ñ Ò Ó Ô Õ Ö Ù Ú Û Ü à á â ã ä å ç è é ê ì í î ï ò ó ô õ ö ù ú û ü ÿ ÿ ÿ ÿ 0 1 2 3 4 5 6 7 8 9 % # \$. , ? ! () [] < > = + - * / \ _ ` ^ ' : Composite 5					One-component One-comp. (Ketone/Aldehyde) Two-components, Methanol Two-components, Ethanol Others				
Accept	Escape	Delete Letter	Cursor Left	Cursor Right	Select	Escape			

5.5.13.3 Nominal Titrant Concentration

The user can enter the titrant concentration.

5.5.13.4 Standardized Titrant Concentration

The user can manually enter the exact titrant concentration.

Nominal Titrant Conc.					Standardized Titrant Conc.				
Enter the nominal titrant concentration.					Enter the standardized titrant conc.				
5.0000 mg/mL					5.0000 mg/mL				
Low Limit: 0.0010 mg/mL High Limit: 20.0000 mg/mL					Low Limit: 4.0000 mg/mL High Limit: 6.0000 mg/mL				
Accept	Escape	Delete Digit			Accept	Escape	Delete Digit		

5.5.13.5 Titrant Age Reminder

The user can set a reminder that a verification of the titrant concentration is necessary. When the set reminder period has expired, a warning message will be displayed on the main screen. The reminder period will reset once the titrant is restandardized or the set time is modified.

Titrant Age Reminder

Enter the time allowed to elapse before the standardization reminder appears.

days hours minutes
█ 2 00 00

Press Next to move to the next entry.

ACCEPT	Escape	Delete Digit	Next
--------	--------	--------------	------

5.5.14 Control Parameters

The user can access and edit the parameters related to the titration.

Control Parameters

Select the option to be modified.

Start Mode:	Cautious
Standby Mode:	Enabled
Standby Duration:	12:00 [hh:mm]
Imposed Current:	20 μ A
Dosing Parameters:	
Timed Increment:	1 second
End Point Value:	180.0 mV
Signal Averaging:	3 Readings
Flow Rate:	5.0 mL/min

Select	Escape		
--------	--------	--	--

METHODS

5.5.14.1 Start Mode

The user can select the starting mode for the titration. In *Cautious* mode, the titrant dosing begins with the minimum dose in order to prevent over-titration. In *Normal* mode, the titrant dosing begins with the median value between the minimum and maximum (i.e. minimum dose 5 μ L, maximum dose 25 μ L, first dose will be 15 μ L).

Start Mode														
Select the KF titration start mode.														
<table border="1"><tr><td>Cautious</td><td colspan="4"></td></tr><tr><td>Normal</td><td colspan="4"></td></tr></table>					Cautious					Normal				
Cautious														
Normal														
Select	Escape													

5.5.14.2 Standby Mode

When enabling this option the titrator will automatically revert to Standby mode after a titration is completed.

See also the *Standby Duration* option.

Standby Mode														
Select the option for standby mode.														
<table border="1"><tr><td>Disabled</td><td colspan="4"></td></tr><tr><td>Enabled</td><td colspan="4"></td></tr></table>					Disabled					Enabled				
Disabled														
Enabled														
Select	Escape													

5.5.14.3 Standby Duration

The user can enter the period of time which the cell is kept dry and ready for subsequent analysis after a titration has finished.

Standby Duration				
Enter time period (10 or more minutes) which titrator will run in standby mode.				
hours		minutes		
12		00		
Low Limit: 00:10				
High Limit: 23:59				
Press Next to move to the next entry.				
Accept	Escape	Delete Digit	Next	

The user can set the standby period up to 23 hours and 59 minutes.

5.5.14.4 Imposed Current

The **HI 903** uses a bivoltametric electrode system. During a titration, the titrator monitors the voltage required to maintain a constant polarization current (imposed current).

This option allows the user to select the electrode polarization current from the predefined list.

Imposed Current												
Choose the imposed current value in μA .												
<table border="1" style="width: 100%;"> <tr><td>1 μA</td></tr> <tr><td>2 μA</td></tr> <tr><td>5 μA</td></tr> <tr><td>10 μA</td></tr> <tr><td>15 μA</td></tr> <tr><td>20 μA</td></tr> <tr><td>30 μA</td></tr> <tr><td>40 μA</td></tr> </table>					1 μA	2 μA	5 μA	10 μA	15 μA	20 μA	30 μA	40 μA
1 μA												
2 μA												
5 μA												
10 μA												
15 μA												
20 μA												
30 μA												
40 μA												
Select	Escape											

Note: Higher polarization currents will speed the contamination of the electrode and potentially degrade samples.

METHODS

5.5.14.5 Dosing Parameters

The user can set the minimum and maximum volume of titrant / dose. The titrant min and max dose values are determined by the type of reagent, reagent concentration and the expected content of water in the sample. Correct determination of these values is necessary in order to prevent over-titration and ensure the highest possible accuracy.

Dosing Parameters				
Enter the minimum and maximum dose.				
0.5000 μ L - min Vol				
20.000 μ L - max Vol				
Press Next to move to the next entry.				
Accept	Escape	Delete Digit	Next	

5.5.14.6 Timed Increment

The user can enter the period of time between two successive doses. The time period must be defined in accordance with the specifics of the analysis.

Timed Increment				
Choose the period for wait time up to the next dose dispensing.				
0.5 seconds				
1. second				
2 seconds				
3 seconds				
4 seconds				
5 seconds				
Select	Escape			

5.5.14.7 End Point Value

This option defines the mV value at which the titration equivalence point (endpoint) has been reached.

The pre-titration is completed when the mV is under the endpoint value, for a user defined period of time (see Section 5.5.14.4, *Endpoint Stability Time*).

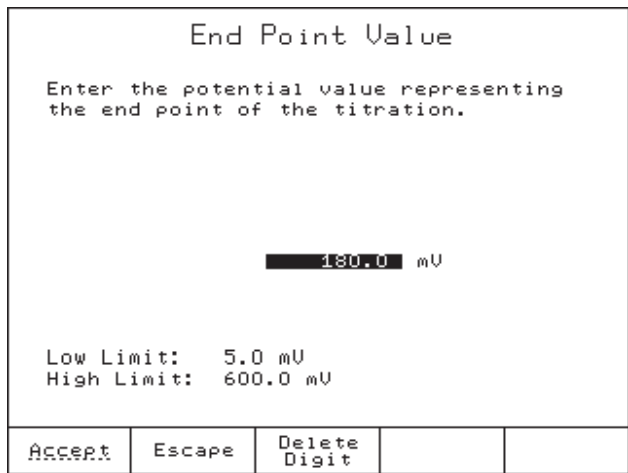

The mV value can be set from 5.0 to 600.0 mV.

5.5.14.8 Signal Averaging

This option enables averaging of the mV reading when enabled.

If *1 Reading* is selected, the filtering is disabled. The titrator will take the last reading and places it into a "moving window" along with the last 2, 3 or 4 readings (depending on the selected option). The average of those readings is displayed and used for calculations.

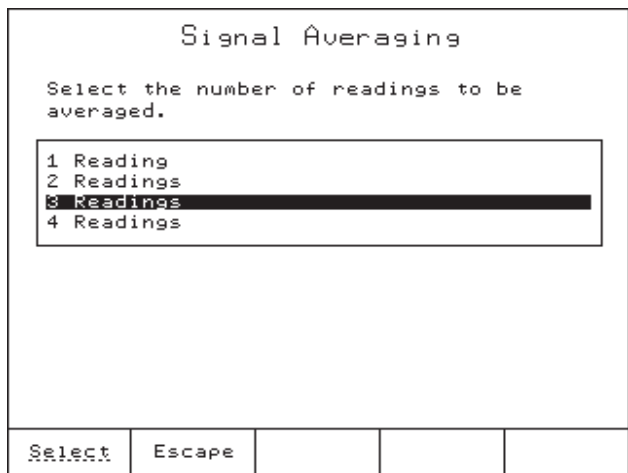

Averaging more readings is helpful when a noisy signal is received from the electrode.

METHODS

5.5.14.9 Flow Rate

The flow rate for the dosing system can be set by the user in an interval of 0.1 to two times the burette volume: 0.1 to 10 mL/min for a 5 mL burette

Flow Rate				
Enter the titrant flow rate.				
5.0 mL/min				
Low Limit: 0.1 mL/min				
High Limit: 10.0 mL/min				
Accept	Escape	Delete Digit		

Note: The titrator will automatically detect the burette size and display the correct high limit volume.

The flow rate is set for all burette operations.

5.5.15 Termination Parameters

Termination Parameters				
Select the option to be modified.				
Maximum Duration: 3600 sec				
Maximum Titrant Volume: 20.0000 mL				
Termination Criterion: mV End Point				
End Point Stability Time: 4 sec				
Select	Escape			

This screen allows the user to set the control parameters related to the end of the titration.

5.5.15.1 Maximum Duration

Specify the maximum time a titration is allowed to run. Once this point is reached the titration will be terminated even if the end point is not reached.

The time can be set from 10 to 3600 seconds.

Maximum Duration				
Enter the time period after the titration is automatically stopped.				
3600 seconds				
Low Limit: 10 seconds				
High Limit: 3600 seconds				
Accept	Escape	Delete Digit		

5.5.15.2 Maximum Titrant Volume

The maximum titrant volume used in the titration must be set according to the analysis. If the titration end point is not reached, the titration will be terminated after the maximum titrant volume has been dispensed. The error message ("Limits Exceeded") will appear on the display.

Range is from 0.100 to 50.000 mL.

Maximum Titrant Volume				
Enter the maximum titrant volume to be dispensed.				
10.0000 mL				
Low Limit: 0.1000 mL				
High Limit: 50.0000 mL				
Accept	Escape	Delete Digit		

METHODS

5.5.15.3 Termination Criterion

This screen allows the user to set the titration termination criterion.

Termination Criterion							
Select titration termination criterion.							
<table border="1"><tr><td>mV End Point</td></tr><tr><td>Absolute Drift</td></tr><tr><td>Relative Drift</td></tr></table>					mV End Point	Absolute Drift	Relative Drift
mV End Point							
Absolute Drift							
Relative Drift							
Select	Escape						

- mV End Point The titration is terminated when the potential remains below a set mV value for a specified period of time (see Section 5.5.14.4, *End Point Stability Time*).
- Absolute Drift The titration is terminated when the actual drift is less than the pre-defined absolute drift value.
- Relative Drift The titration is terminated when the actual drift is less than the sum between the initial drift and the predefined relative drift.

5.5.15.4 End Point Stability Time

This screen allows users to set the time period in which the electrode potential must remain stable.

This setting is in accordance with the *mV end point* termination criterion.

End Point Stability Time				
Enter the time period necessary to validate the titration end point.				
4 seconds				
Low Limit: 1 seconds				
High Limit: 30 seconds				
Accept	Escape	Delete Digit		

5.5.16 Result Unit

The titrator provides the results based on the selected units.

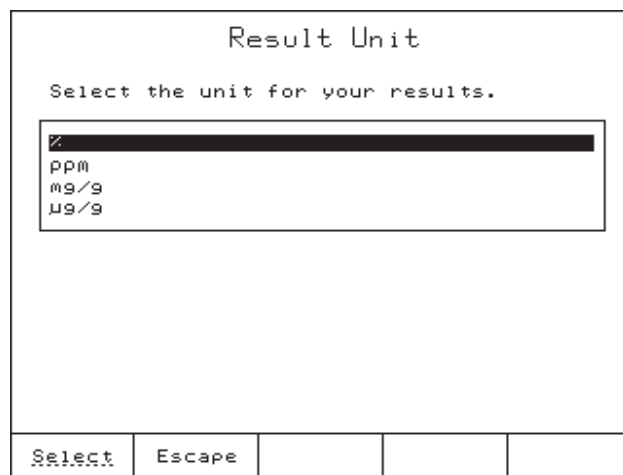

5.6 Printing

To print method parameters, press Method Options from the main screen, then Print Method.

If no printer is connected to the dedicated socket, or if the printer is offline, an error message will appear on the display (see Section 8.3.3, *Connecting a Printer* for information about connecting a printer to the titrator).

Chapter 6. Contents

6 TITRATION 6 - 3

6.1 Idle 6 - 3

6.2 Pre-titration 6 - 3

6.3 Drift Analysis 6 - 4

6.4 Standby 6 - 5

6.5 Sample Analysis 6 - 6

6.6 Titrant Standardization 6 -11

6 TITRATION

6.1 Idle

The titrator first enters Idle mode when it is switched on. All of the **HI 903**'s software features and adjustable parameters can be accessed from the Idle state. This includes all of the user-adjustable method parameters, solvent handling system, file transfers, calibration checks, software upgrades, options for interface with PC and accessories as well as burette options.

To access the titration menu (*Process* screen) press .

The titration (Sample Analysis or Titrant Standardization) is performed with the selected method. Be sure that the selected method is customized in accordance with the specifics of the application.

Before performing a titration make sure that the following conditions are met:

- All of the attached systems (e.g.: solvent system) are properly assembled.
- The right amount of solvent is present in the beaker (between the min and max marks) for best reproducibility.

The following intermediary stages are performed automatically before starting the analysis:

- **Solvent pre-titration**
- **Drift analysis (Automatic Drift Entry only)**

When the drift analysis process is finished, the titrator enters **Standby** mode. At this point, a titration can be initiated.

6.2 Pre-titration

In pre-titration the residual water on the interior surface of the titration vessel, the water contained in the entrapped air and the small amount of water from the solvent is eliminated. The **HI 903** reacts residual water by adding titrant until the specified endpoint potential is reached. This setting is associated with the active method. After the electrode potential has stabilized, the titrator moves into the Drift Rate Determination Stage.

When the pre-titration is started, the stirrer is automatically turned on (when *Internal* or *External* stirrer is selected).

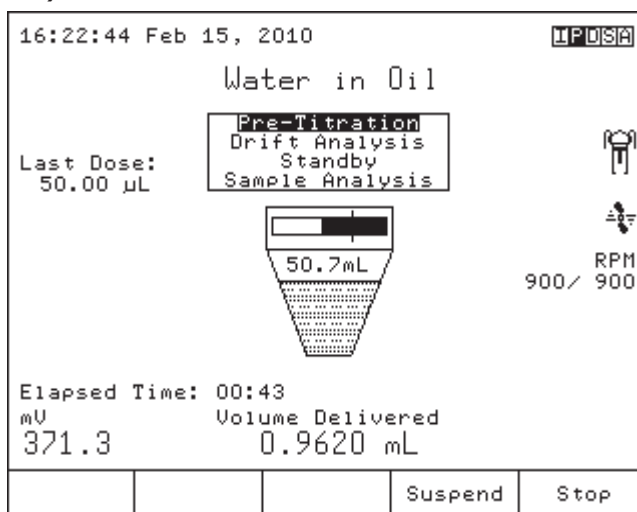

TITRATION

During the pre-titration the user cannot change the currently selected method or access the method parameters.

Note: If the pre-titration lasts longer than 30 minutes the titrator switches to **Idle** mode. Errors may have occurred in your titration system (beaker is not properly sealed, wrong or missing titrant, unconnected or bad electrode, etc.). Check the system and start the pre-titration again.

6.3 Drift Analysis (Automatic Drift Entry only)

While in this mode the **HI 903** conducts an automatic one minute analysis which determines the amount of moisture leaking into the cell from the atmosphere. Despite the titration vessel being tightly sealed, water will still seep into the cell. The amount of water that migrates into the cell per unit time is known as the background drift rate, or the drift rate.

The drift rate is determined by keeping track of the number of very small, successive doses of titrant required to maintain the 'dryness' of the solvent over the course of a minute. The rate at which water leaks into the cell is then calculated and reported by the HI 903 in units of $\mu\text{g}/\text{min}$. The **HI 903** uses the drift rate determined during this state to automatically subtract the quantity of water which leaks into the cell during a titration from titration results. This is especially important for titration accuracy when analyzing samples with very low water content where the amount of water which has leaked into the cell is a considerable fraction of the total water titrated during the analysis.

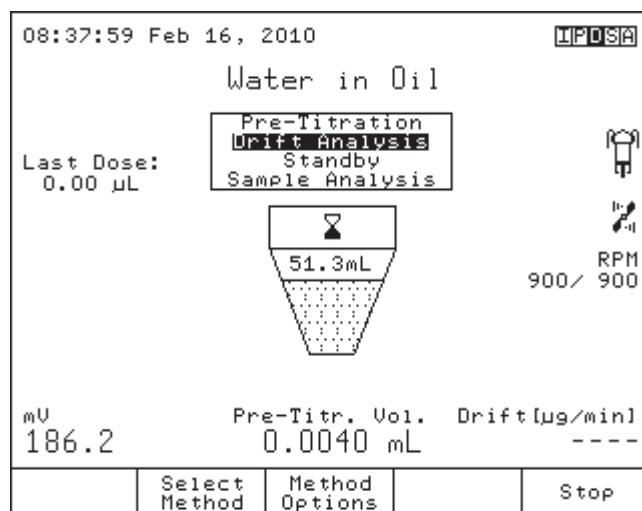

When the drift becomes stable the titrator switches to **Standby** mode.

During the drift analysis, if the titrator cannot maintain cell dryness, the titrator reverts to pre-titration.

Note: If the drift entry mode is set as Manual the drift analysis stage is skipped.

6.4 Standby

After the drift rate has been determined, the **HI 903** moves into **Standby** mode. In standby mode the dryness of the titration cell is maintained and the drift rate is continuously monitored and updated.

From **Standby** mode a sample analysis, titrant standardization or drift rate logging session can be launched as well as method selection, customization of method parameters, and general options (external keyboard only, by pressing <<Home>>).

After an initial titrator setup and prior to the first titration or standardization, the drift rate should be allowed to settle in **Standby** mode for 45 min. This ensures that the drift rate is stable and reflects the actual rate at which water vapor is entering the cell rather than representing a slow drying of the air between the solvent and the top of the cell. The stabilization can be verified by examining the drift rate vs. time curve which can only be accessed from standby mode.

During standby, if the drift becomes unstable, the titrator switches back to Drift Analysis mode.

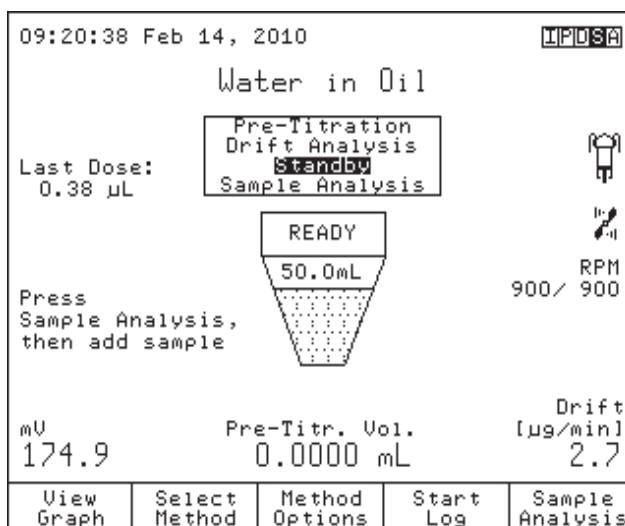



TITRATION

6.5 Sample Analysis

While in **Standby** mode, press .

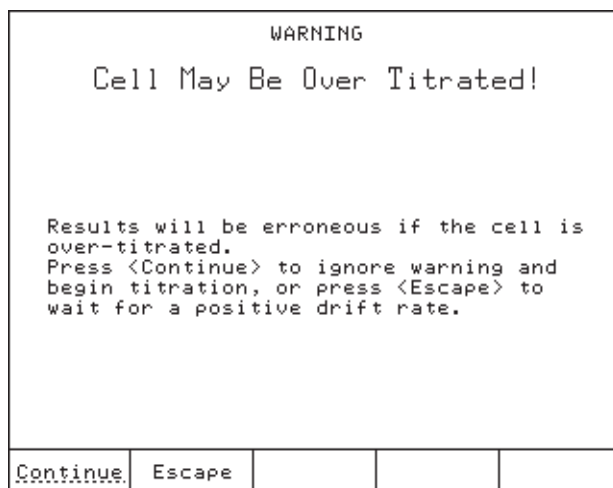
Note: If the drift value is zero a warning message appears to inform the user that the solvent may be overtitrated.



The user can choose to continue the titration by pressing  or to return to **Standby** mode by pressing .

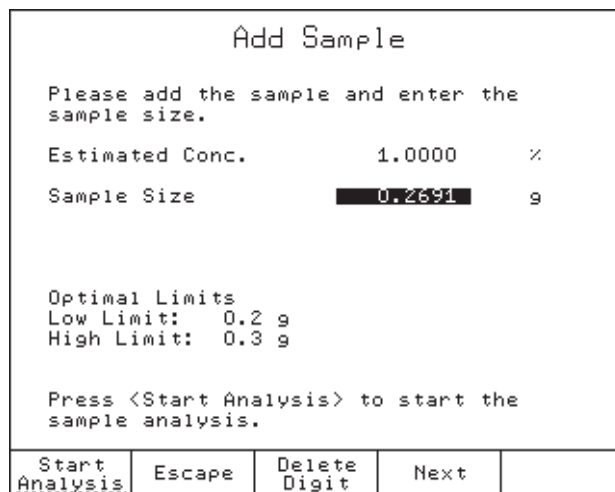

Entering estimated concentration: The user has the option to enter the estimated concentration, which is in accordance with the pre-titration amount and the suggested optimal limits.

Adding the sample: The user must add the sample into the titration vessel via the sample port.

Entering sample size: The user has two options to determine the sample size.

Manual Entering

Follow the steps below:

Sample size by mass:

1. Measure the mass of the sample in a weigh boat or syringe.
2. Slide the sample plug up out of the vessel top to open the sample port, or insert the syringe needle through the septum.
3. Rapidly add the sample through the sample port ensuring that ALL of the sample is transferred to the solvent. Avoid any contact between the sample and the cell cover.
4. Replace the sample plug into the cell cover, or remove the syringe from the septum.
5. Determine the mass of the 'empty' weigh boat or syringe.
6. Calculate the mass of the sample added (subtract the mass of the emptied weigh boat or syringe from the mass of the full weigh boat or syringe).
7. Enter the calculated mass of the sample.

Sample size by volume:

1. Attach a long needle (approximately 6 cm for best control) to a precision-volume syringe large enough to hold at least one complete sample volume.
2. Rinse the syringe and needle with sample several times by drawing in a small portion of sample, fully extending the plunger, shaking to coat the syringe interior and expelling the sample into a waste collection container.
3. Draw enough sample into the syringe for at least one titration.
4. Dry the outside of the needle with a lint free wipe or tissue.
5. Insert the needle through the septum in the sample port. Push the syringe through the septum until the end of the needle is approximately 1 cm from the surface of the solvent.
6. Steadily dispense the appropriate volume of sample ensuring that the sample is introduced directly into the solvent and does not splash or spatter onto the wall of the titration vessel, electrode, or dispensing tip.
7. Draw a small amount of air from inside the cell into the syringe to ensure that no sample drops remain on the tip of the needle.
8. Remove the syringe and needle from the septum taking care to not touch the needle to the solvent or other internal cell components.
9. Enter the calculated mass of the sample.

Sample size by pieces:

1. Enter the number of pieces that were added to the titration vessel.

TITRATION

Automatic Mass Acquisition from Analytical Balance

It is available only for *Sample Mass* and *Sample Volume* types.

The sample size can be automatically acquired from the balance when connected to the titrator using the RS232 interface.

Note: The user must make sure that the balance and the titrator are properly configured and the balance feature is enabled (see Section 4.10, Setup Balance Interface).

Sample Weighing				
Balance: Lab Balance				
Initial Weight: 0.2814 g				
Final Weight: -----				
Put weighing boat on the balance.				
Press <Accept> to update weight.				
Accept	Escape		Balance Setup	

Procedure

1. Place the syringe or the weighing boat containing the sample on the balance.
2. Wait until the reading is stabilized and press .
3. Add the sample in the titrator vessel.
4. Place the empty syringe or weighing boat on the balance again.
5. Wait for the reading to stabilize and press .

Sample Weighing				
Balance: Lab Balance				
Initial Weight: 0.2814 g				
Final Weight: 0.0117 g				
Put empty weighing boat on the balance.				
Press <Accept> to update weight.				
Accept	Escape		Balance Setup	

The titrator returns to the previous screen and the sample size is automatically updated. Now the analysis can be started.

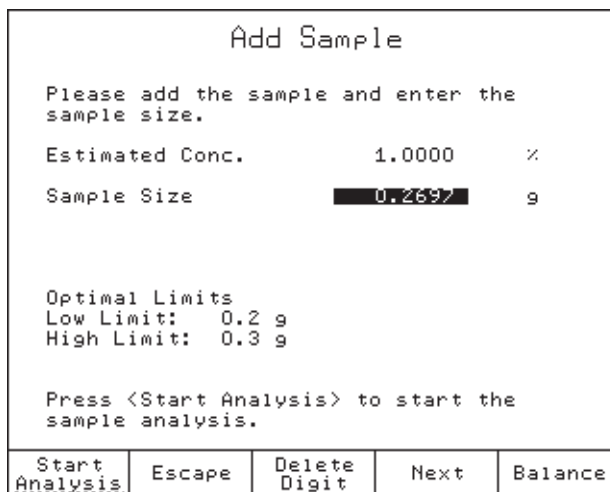

Start Analysis

Press to begin analysis.

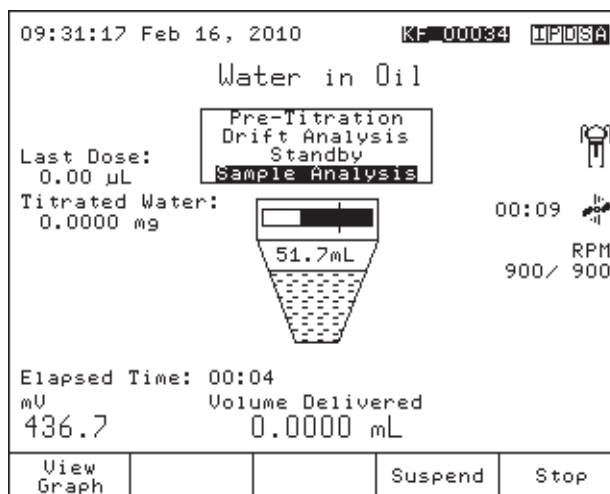

Suspend Titration

While the titration is in progress, you can temporarily stop it by pressing . The burette will stop dispensing titrant.

To continue the titration press .

TITRATION

Viewing the Titration Curve

During a titration, the titration curve can be displayed on the **Titration Graph** screen, by pressing . The titration ID report is also displayed inside the graph window.

Press  to stop the titration manually and return to **Idle** mode.

Press  to stop the titration and return to **Standby** mode.

When the end point is reached the titration is finished and the following screen is displayed.

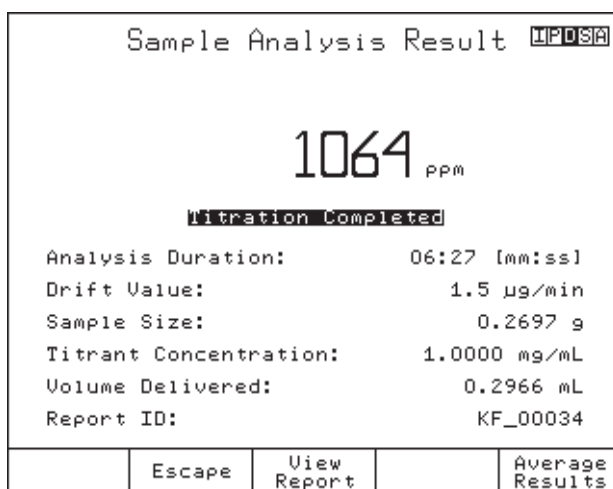

This screen displays information about the titration (duration, drift value used for compensation, sample size, titrant concentration, dispensed titrant volume, titration report ID).

Press  to see the titration report.

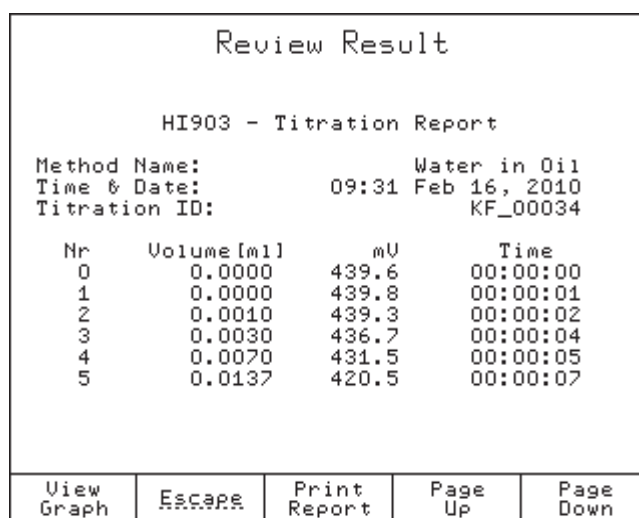

Press  to see the titration graph.

Press  to print the report.

Averaging Sample Analysis Results

By pressing , results will be added to the *Sample Analysis History* in order to obtain an average of titration results.

Use the  and  keys to scroll the concentration results list.



Use  to choose the sample concentration results that will be used for averaging.

Sample Analysis History	
Date/Time	Sample Conc. [%]
May 06, 2009 15:24	9.65
May 06, 2009 15:26	9.23
May 06, 2009 15:30	8.81
Titration Parameters:	
Titrant Conc.:	5.0010 mg/mL
Sample Size:	0.5960 g
Average Sample Conc.:	---- %
Standard Deviation:	---- %
Select	Escape
	Delete

Note: When there are no results selected dashes will appear in the Average Sample Concentration and the Standard Deviation fields.

6.6 Titrant Standardization

While in **Standby** mode, press .

07:59:15 Mar 24, 2011		IPDUSA
Stdz 5mg/mL w/ Tartrate		
Last Dose: 0.13 µL	Pre-Titration Drift Analysis Standby Titrant Stdz.	
Press Stdz. Titrant, then add standard	READY 50.0mL 	
mV 180.8	Pre-Titr. Vol. 0.0000 mL	RPM 900/ 900
		Drift [µg/min] 2.8
View Graph	Select Method	Method Options
	Start Log	Stdz. Titrant

Note: If the drift value is zero, a warning message appears to inform the user that the solvent may be overtitrated.

TITRATION

Adding the standard: The user must add the standard into the beaker and enter the standard size. The units of sample size are determined by the method setting.

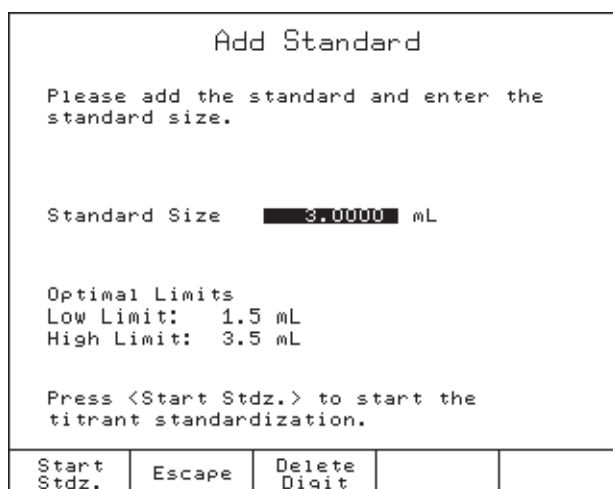

Follow the same procedure as for adding samples (see Section 6.5, Sample Analysis)

Start Standardization

Press to begin standardization.

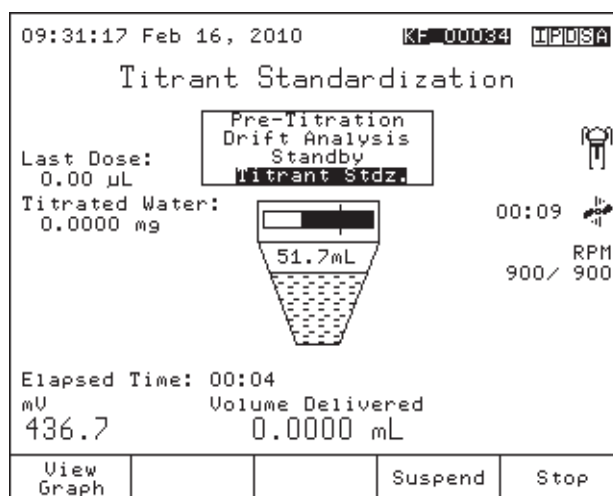

Note: During titrant standardization the user has the same options as a sample analysis (see Section 6.5, Sample Analysis).

When the titrant standardization is finished the user has two options to update the titrant concentration:

By pressing the titrant is updated with the current result.

By pressing the user can average the titrant concentration using more results.

Standardization Result IPUSA				
1.7925 mg/mL				
Titration Completed				
Analysis Duration:		06:30 [mm:ss]		
Drift Value:		2.1 µg/min		
Standard Size:		0.0317 g		
Standard Concentration:		10.0000 % [W/W]		
Volume Delivered:		1.7763 mL		
Report ID:		KF_00035		
	Escape	View Report	Update Titrant	Average Results

Averaging Titrant Standardization Results

By pressing Average Results results can be added to the sample analysis history in order to obtain an average of titrant concentration.

Titrant Standardization History					
Date/Time	Titer [mg/mL]				
* Feb 16, 2010 11:36	1.7925				
* Feb 16, 2010 11:44	1.7724				
* Feb 16, 2010 11:55	1.7790				
<table style="width: 100%; border: none;"> <tr> <td style="border: none;">Standard Water Content:</td> <td style="border: none; text-align: right;">10.0000 % [W/W]</td> </tr> <tr> <td style="border: none;">Standard Size:</td> <td style="border: none; text-align: right;">0.0227 g</td> </tr> </table>		Standard Water Content:	10.0000 % [W/W]	Standard Size:	0.0227 g
Standard Water Content:	10.0000 % [W/W]				
Standard Size:	0.0227 g				
<table style="width: 100%; border: none;"> <tr> <td style="border: none;">Average Titer:</td> <td style="border: none; text-align: right;">1.7813 mg/mL</td> </tr> <tr> <td style="border: none;">Standard Deviation:</td> <td style="border: none; text-align: right;">0.0102 mg/mL</td> </tr> </table>		Average Titer:	1.7813 mg/mL	Standard Deviation:	0.0102 mg/mL
Average Titer:	1.7813 mg/mL				
Standard Deviation:	0.0102 mg/mL				
<u>Unselect</u>	Escape	Update Titrant		Delete	

Use the ▲ and ▼ keys to scroll the concentration results list.

Use Select to choose the titrant concentration results that will be used for averaging.

Press Update Titrant to update the concentration with the current average.

Note: When there are no results selected dashes will appear in the average titrant concentration and the standard deviation fields. Update Titrant is not available in this case.

Chapter 7. Contents

7. AUXILIARY FUNCTIONS	7 - 3
7.1 Air Pump	7 - 3
7.1.1 Filling the Beaker	7 - 3
7.1.2 Emptying the Beaker.....	7 - 3
7.2 Burette	7 - 4
7.2.1 Prime Burette	7 - 4
7.2.2 Rinse Tip	7 - 5
7.2.3 Manual Dispense	7 - 5
7.2.4 Purge Burette	7 - 6
7.3 Stirrer	7 - 6
7.4 Results	7 - 7
7.4.1 Review Last Titration Report	7 - 7
7.4.2 Review Available Reports	7 - 8
7.4.3 GLP Data	7 - 8
7.4.4 Meter Information	7 - 9
7.4.7 Setup Titration Report	7 - 10

7 AUXILIARY FUNCTIONS

7.1 Air Pump

The air pump is used to add or remove the solvent in the titration beaker without exposure to atmospheric moisture.

To start the air pump, press  from the *Idle* screen.

The air pump can be stopped by pressing .

7.1.1 Filling the Beaker

To add solvent to the titration vessel:

1. Depress the 'fill' button on the top of the pump housing. Pressing the rubberized button creates a seal which provides the pressure required for the solvent to flow into the cell. Hold the button down until the level of solvent inside the cell reaches the 'min' indicator line. If the solvent is not flowing, or is flowing very slowly, verify that the bottle top assemblies are properly assembled and tightly sealed and that the liquid handling tubing reaches the bottom of the solvent bottle.
2. When the level of solvent inside the titration cell reaches the 'min' line release the **Fill** button and deactivate the air pump with the  option key.
3. The **HI 903** will prompt the user to verify that the titration cell has been filled to the 'min' line (approx. 50 mL).

Estimated Cell Volume				
Confirm the cell has been filled to the "Min" line or enter approximate cell volume.				
<div style="background-color: black; color: white; display: inline-block; padding: 2px 10px;">50.0</div> mL				
Low Limit: 0.0 mL				
High Limit: 200.0 mL				
Accept	Escape	Delete Digit		

Press  to return to *Idle* screen.

7.1.2 Emptying the Beaker

To remove the waste from the titration vessel:

1. Loosen the waste tube fitting slightly and slide the waste tube down until it reaches the bottom of the beaker.
2. Press and hold the **Empty** button until all of the waste is removed from the beaker.
3. Return the waste tube back into its original position and re-tighten the fitting.

AUXILIARY FUNCTIONS

7.2 Burette

To access the **Burette** screen, press Burette from the *Idle* screen.

Highlight the desired option and then press Select.

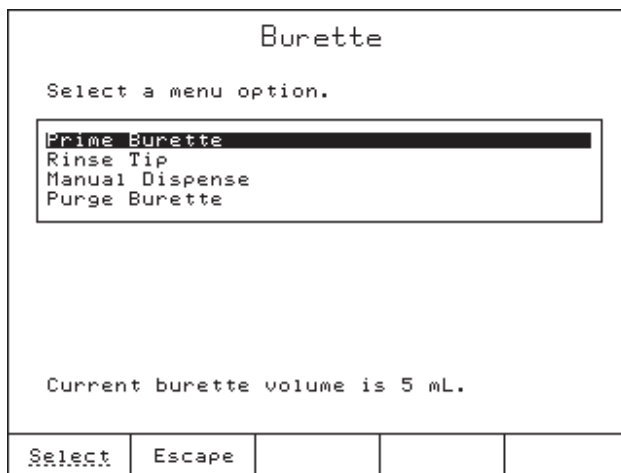

Note: Do not perform burette functions with solvent below the "Min" sign. Doing so could spray titrant on the beaker top or other components.

7.2.1 Prime Burette

After solvent has been added to the titration cell, the burette can be primed with titrant. The priming process consists of several cycles of filling and emptying the burette with titrant. It ensures that any air, water or water vapor in the burette or tubing is removed. Two rinse cycles of burette are shown in the figure below. The dispensing tube is connected on the right side and the aspiration tube on the left side.

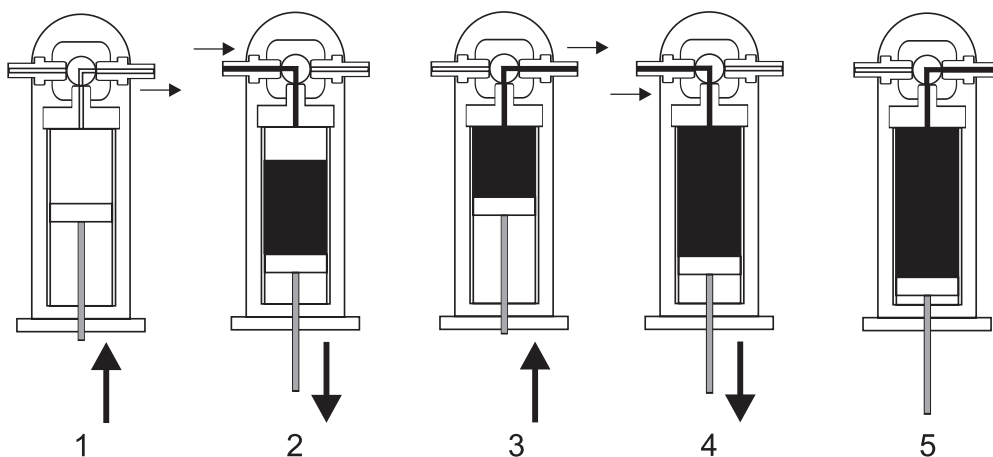

Note: Before starting this operation, the aspiration tube must be inserted into the titrant bottle.

AUXILIARY FUNCTIONS

To prime the burette, select *Prime Burette* from the **Burette** screen. Enter the number of rinses and press .

The number of burette rinses can be set between 1 and 5 (we recommend at least three rinses to assure that the air bubbles are completely removed).

Total Burette Rinses				
Enter the total number of burette rinses.				
3				
A minimum of three rinses is recommended.				
Accept	Escape	Delete Digit		

7.2.2 Rinse Tip

A 0.25 mL dose of titrant will be dispensed from the burette when this operation is selected. This operation will eliminate any contamination from the anti-diffusion dispensing tip.

7.2.3 Manual Dispense

Manual Dispense allows a defined titrant volume to be be dosed. Select the *Manual Dispense* option and press . The **Manual Volume Dispense** screen will become active and the display will prompt you to enter the desired volume to be dispensed.

Manual Volume Dispense				
Enter the amount of volume to be dispensed.				
1.000 mL				
Current burette volume is 5 mL.				
Accept	Escape	Delete Digit		

AUXILIARY FUNCTIONS

The manual dispense volume must be between the limits shown below:
0.001 to 4.500 mL for a 5-mL burette

7.2.4 Purge Burette

This option allows the burette to be emptied before cleaning and/or storing.

Note: Before starting this operation, remove the aspiration tube from the titrant bottle.

The figures below show the steps in a purge burette operation.

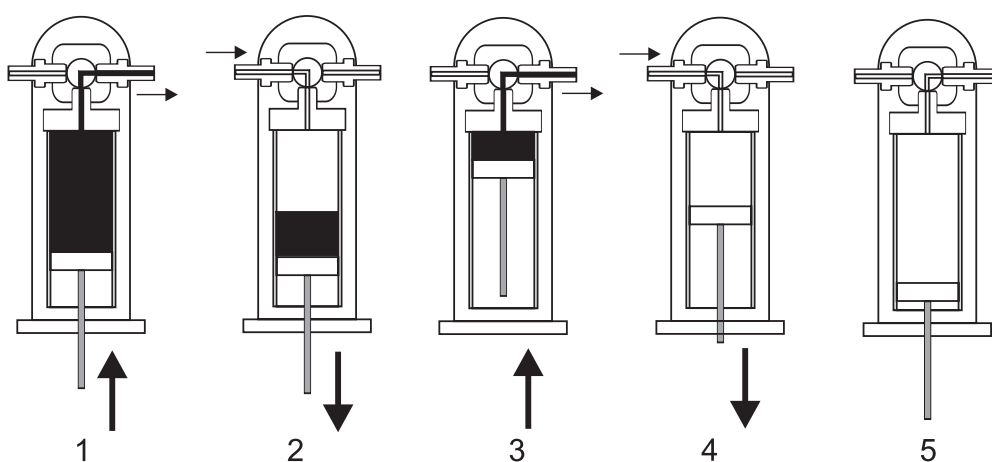

7.3 Stirrer

Note: When custom stirrer is selected (see Section 4.4, *Stirrer in General Options chapter*), the commands related to the stirrer are not available.

The stirrer can be turned on and off by pressing while in *Idle* mode.

During the titration process the stirrer cannot be turned off.

The stirring speed is set within the method parameters (see Section, 5.5.6 *Stirring Speed*).

During the titration process, the stirring speed can be manually adjusted by using the \triangle and ∇ keys.

7.4 Results

To access the "Data Parameters" screen, press  button.

From the **Data Parameters** screen you can access the following options:

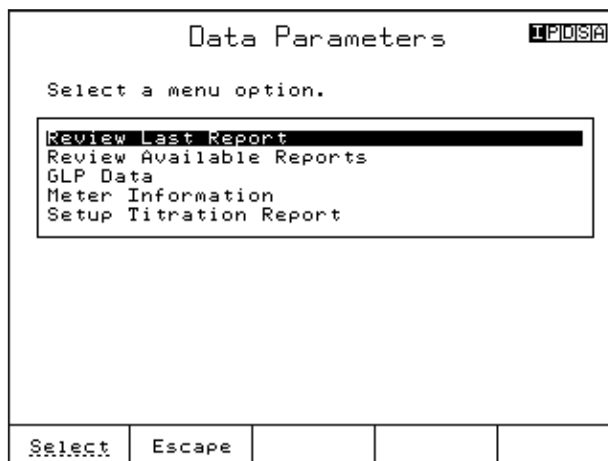

```
Data Parameters L.PUSA
Select a menu option.
Review Last Report
Review Available Reports
GLP Data
Meter Information
Setup Titration Report
Select  Escape  [ ]  [ ]  [ ]
```

7.4.1 Review Last Titration Report

The last titration report can be reviewed.

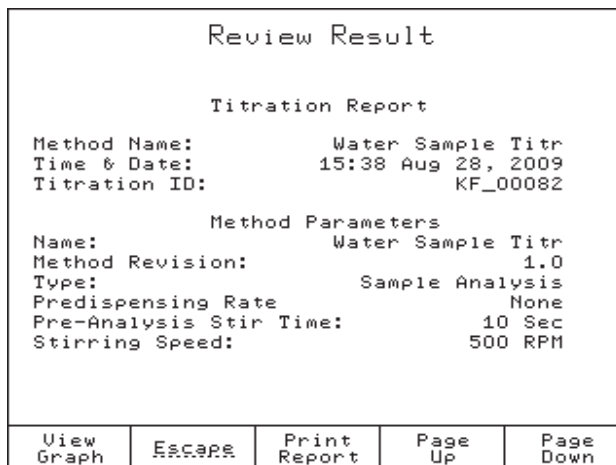



```
Review Result
Titration Report
Method Name:      Water Sample Titr
Time & Date:      15:38 Aug 28, 2009
Titration ID:     KF_00082
Method Parameters
Name:             Water Sample Titr
Method Revision:  1.0
Type:             Sample Analysis
Predispensing Rate:  None
Pre-Analysis Stir Time: 10 Sec
Stirring Speed:   500 RPM
View Graph  Escape  Print Report  Page Up  Page Down
```

The titration graph can be reviewed by selecting .

The information seen in the report is based on the selections made in the **Setup Titration Report** screen.

The following option keys are available:

-  Review the titration graph.
-  Print the titration report.

AUXILIARY FUNCTIONS

7.4.2 Review Available Reports

Up to 100 reports can be saved on the titrator. To view one of the saved reports highlight a report and then press .

All of the saved reports can be reviewed and printed.

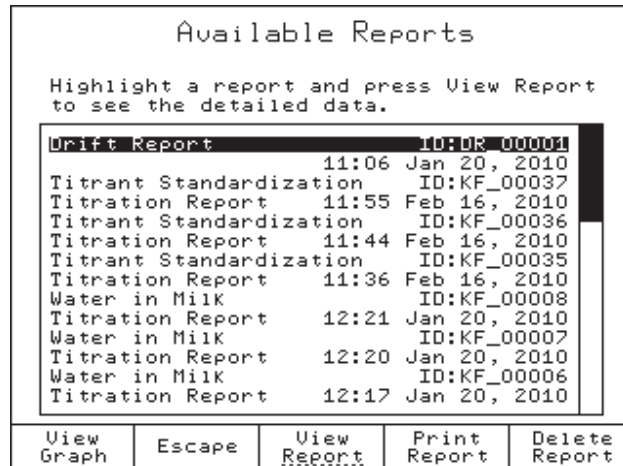

The report contains only the information selected in the **Setup Titration Report** screens during report generation.

The following option keys are available:



Review the titration graph.



Print the titration report.



Delete the selected report.

7.4.3 GLP Data

GLP data can be optionally be displayed in each report.

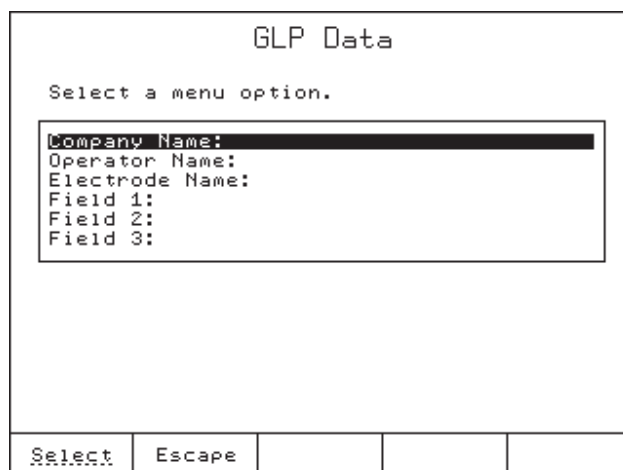

Enter up to 20 alphanumeric characters for each option from **GLP Data** screen.

- Company Name:* Allows the company name to be recorded in each report.
- Operator Name* Allows the operator name to be recorded in each report.
- Electrode Name* Allows the electrode name to be recorded in each report.
- Fields 1, 2, 3* Allows any additional information to be recorded in each report.

The fields must be selected from the **Setup Titration Report** screen (see Section 7.4.5, *Setup Titration Report*) in order to be displayed in the titration report.

Meter Information			
HI 903 Karl Fischer Volumetric Titrator			
SERIAL NUMBER			
Titrator Serial Number:	03103201		
Analog Board Serial Number:	32100102		
Pump Serial Number:	70094603		
SOFTWARE VERSION			
Titrator Software Version:	v1.00		
Base Board Software Version:	v2.7		
Pump Software Version:	v1.4		
Analog Calibration Date:	Feb 16, 2010		
Escape	Print		

7.4.4 Meter Information

Displays titrator configuration data.

Titrator Serial Number: The serial number of the titrator base board.

Analog Board Serial Number: The serial number of the titrator analog board.

Dosing Pump Serial Number: The serial number of the connected pump.

Titrator Software Version: The current software version installed on the titrator.

Base Board Software Version: The current software version present on the base board of the titrator.

Dosing Pump Software Version: The current software version for the pump.

Analog Calibration Date: Manufacturer calibration date of analog board.

Note: *If more than 1 year elapsed from the calibration date of the analog board, the message **Analog Calibration Due** will appear on the main screen and analog board recalibration must be performed.*

AUXILIARY FUNCTIONS

7.4.5 Setup Titration Report

Customize a unique report to record the titration results. An asterisk means that it will be included in the titration report.

Setup Titration Report				
Select fields to be saved in the report.				
<ul style="list-style-type: none">* Result and Units* Titration Method* Standard/Sample Size* End Point Volume* Titration Duration* Date and Time* Titration Ended By* All Data PointsMethod ParametersCompany NameOperator NameElectrode NameField 1Field 2				
Unselect.	Escape	Save Report	Page Up	Page Down

Chapter 8. Contents

8	MAINTENANCE, PERIPHERALS	8 - 3
8.1	Burette Maintenance	8 - 3
8.1.1	Burette Assembly	8 - 3
8.1.2	Changing the Burette	8 - 3
8.1.3	Disassembling the Dispensing Tube and Aspiration Tube	8 - 4
8.1.4	Assembling the Dispensing Tube and Aspiration Tube	8 - 4
8.1.5	Cleaning the Burette	8 - 5
8.1.6	Burette Preparation (Filling with Titrant)	8 - 7
8.2	Probe Maintenance	8 - 8
8.3	Fuse Replacement	8 - 9
8.4	Peripherals	8 - 9
8.4.1	Connecting an External Display	8-10
8.4.2	Connecting an External PC Keyboard	8-10
8.4.3	Connecting a Printer	8-12
8.4.4	Connecting to a Computer	8-12

8 MAINTENANCE, PERIPHERALS

The 5-mL burette included with the titrator exceeds the ISO 8655 standard for the accurate delivery of liquids by a motor-driven piston burette.

8.1 Burette Maintenance

8.1.1 Burette Assembly

The burette is delivered with a 5-mL syringe inside and with all the accessories mounted (see Section 2.3.4.2, *Attaching the Burette* for assembly details). The burette assembly consists of a rigid housing which holds the glass syringe, a 3-way valve and is connected to titrant tubing with specially designed fittings.

Note: *The dispensing tube has two fitted ends. One end is equipped with a burette fitting and the other is equipped with a beaker fitting.*

8.1.2 Changing the Burette

Remove the burette from the pump assembly by sliding it forward and then slide the new burette into place (see the picture below).

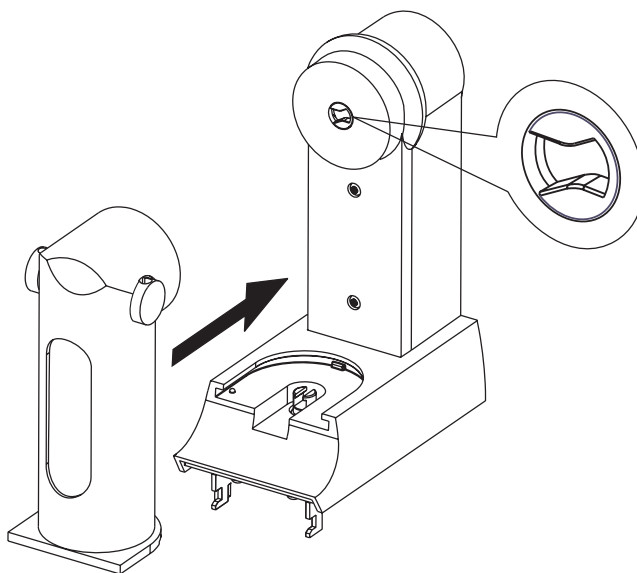

MAINTENANCE, PERIPHERALS

8.1.3 Disassembling the Dispensing Tube and Aspiration Tube

Both the aspiration and the dispensing tubes have a fitting and a tube protector. The aspiration tube will be mounted in the left side and the dispensing tube will be mounted in the right side of the burette.

To remove the dispensing tube and the aspiration tube follow these steps:

- Slide the tube protector up (A);
- Remove the tube lock (B) from the burette holder;
- Unscrew the fitting (C);
- Repeat these steps for the aspiration tube.

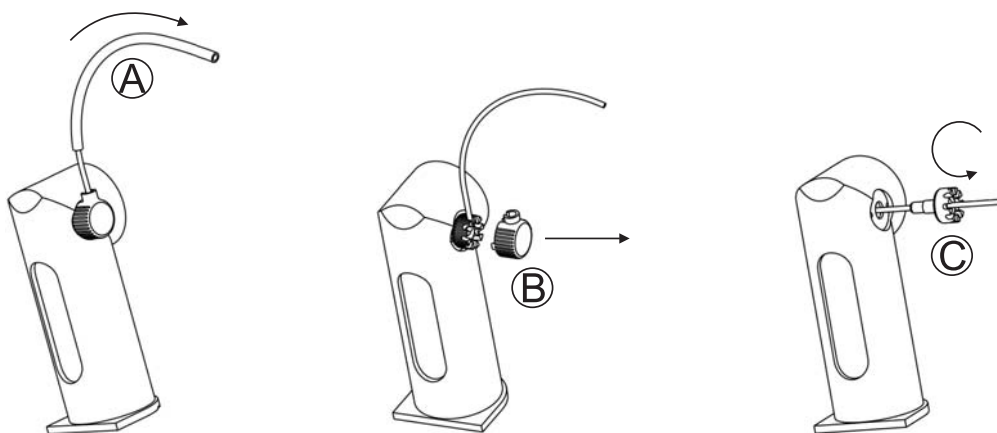

8.1.4 Assembling the Dispensing Tube and Aspiration Tube

To attach the dispensing tube and the aspiration tube follow these steps:

- Insert the end of the dispensing tube with the tan-colored fitting (A) into the valve outlet;
- Screw in the fitting so that the highest of its 9 cuts stays vertical in the final position;
- Bend the tube up into vertical position to enter the highest cut of the fitting;
- Put the tube lock on (B) the fitting;
- Slide down the tube protector (C) into the dedicated gap of the tube lock;
- Repeat these steps for the aspiration tube.

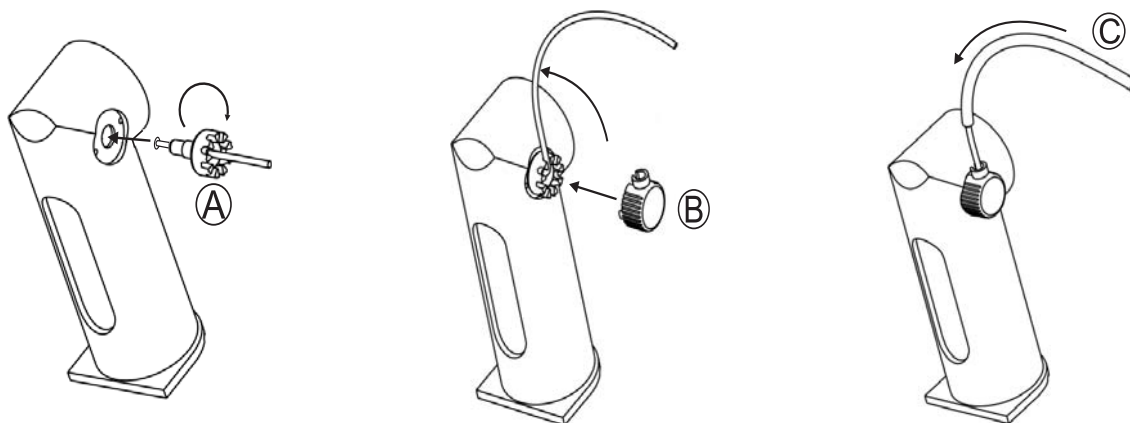

8.1.5 Cleaning the Burette

To clean the burette, follow these steps:

- If the burette is filled with titrant, remove the aspiration tube from the titrant bottle and purge burette (*see Section 7.2.4, Purge Burette*).
- Insert the aspiration tube into the Karl Fischer solvent.
- Prime burette to fill the burette with solvent (use 2 rinses) (*see Section 7.2.1, Prime Burette*).
- During second refilling of the burette remove the aspiration tube from the solvent or cleaning solution and allow the air to replace the liquid in the burette. This will clean the aspiration tube.

If this simple cleaning procedure is not adequate, continue with these steps:

- Slide the burette out from the pump assembly.
- Remove the dispensing and aspiration tubes. Clean them separately or insert new ones.
- Remove the protective cap from the bottom of the burette assembly by using the special tool (HI900942).
- Remove the syringe from the burette assembly by unscrewing it with your fingers.
- Extract the piston from the syringe.
- Clean both the piston and the syringe with appropriate cleaning solution.
- Remove the excess liquid.

MAINTENANCE, PERIPHERALS

Warning: Avoid contact with the titrant with bare hands.

Avoid spilling titrant.

Clean the external side of the syringe and piston to remove aggressive chemicals.

Do not touch the Teflon part of the piston or internal walls of the burette with bare hands or greasy materials.

Consult Manufacturer's MSDS for safe handling instructions.

- Reinsert the piston into the syringe.
- Reinsert the syringe by screwing it in the valve with your fingers.
- Reinsert the protective cap to the bottom of the burette assembly. Carefully position the cap into the burette.
- Slide the burette into the burette stand. Position the piston shaft to couple the pump correctly.
- Priming the burette three times with new titrant is recommended.

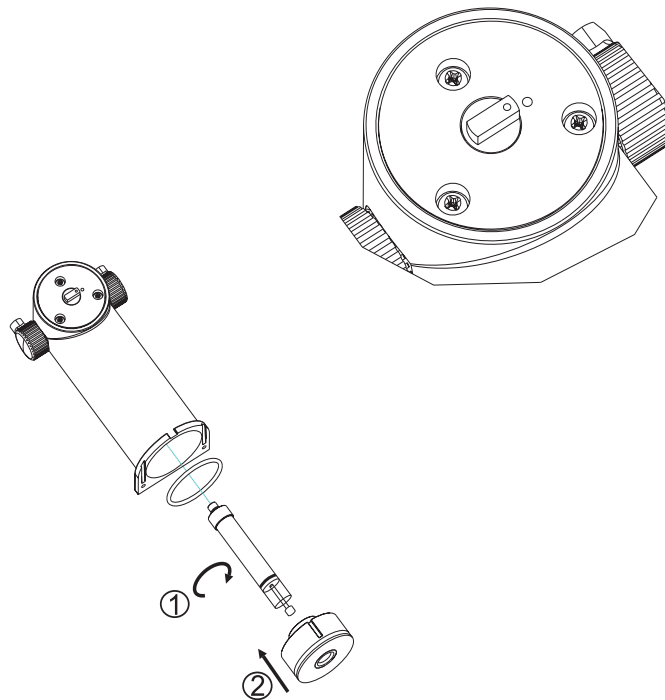

8.1.6 Burette Preparation (Filling with Titrant)

Before starting a titration, the burette must be properly filled with titrant in order to obtain an accurate and repeatable result. To fill the burette, follow the next steps and recommendations:

- If necessary, clean the burette and make sure it is empty and dry.
- From the main screen press .
- Highlight *Prime Burette* option and press .
- Enter the number of times the burette needs to be rinsed (minimum three rinses are recommended allowing air bubbles to be evacuated).
- Press .
- Insert the aspiration tube into the titrant bottle only when the piston is going down and has reached about $\frac{1}{4}$ from the top.

To avoid the presence of air bubbles inside the burette, make sure to have continuous liquid flow inside the burette and a little air just above the liquid level during the first filling is normal. The next filling will evacuate all of the air, no air will be left in the valve.

Sometimes during this process, slight finger tapping on the tubes is helpful to remove any residual air bubbles from the tubes.

MAINTENANCE, PERIPHERALS

8.2 Probe Maintenance

Proper probe maintenance is crucial for reliable measurements and extending the life of the probe. The frequency of maintenance will depend largely on the type of samples that are analyzed. Maintenance may be required if any of the following are observed:

- Slow or no electrode response;
- Noisy mV readings;
- Debris on or between electrode pins
- Coating on electrode pins

If these signs are observed, the electrode pins may be dirty. Rinse the electrode with a solvent that is appropriate for the type of sample used – methanol is usually sufficient. Allow the probe to dry completely before re-installing.

If a more thorough cleaning is required, soak the electrode in HI 7061 Electrode Cleaning Solution for General Use for several hours, then rinse with water followed by methanol. Allow to dry before re-installing.

After allowing the probe to dry, inspect the glass cracks, especially near the electrode pins. Replace the electrode if any cracks are found.

Warning: *Take care to protect the electrode pins from damage! Avoid using brushes/ abrasives to clean the pins. Pins can easily bend, which will cause permanent errors in mV readings!*

8.3 Fuse Replacement

To replace the fuses, follow these steps:

- Turn off the titrator.
- Remove the power cord from the power connector located on the rear side of the titrator case.
- With a screw driver open the fuse holder cover located at the rear of the Titrator.

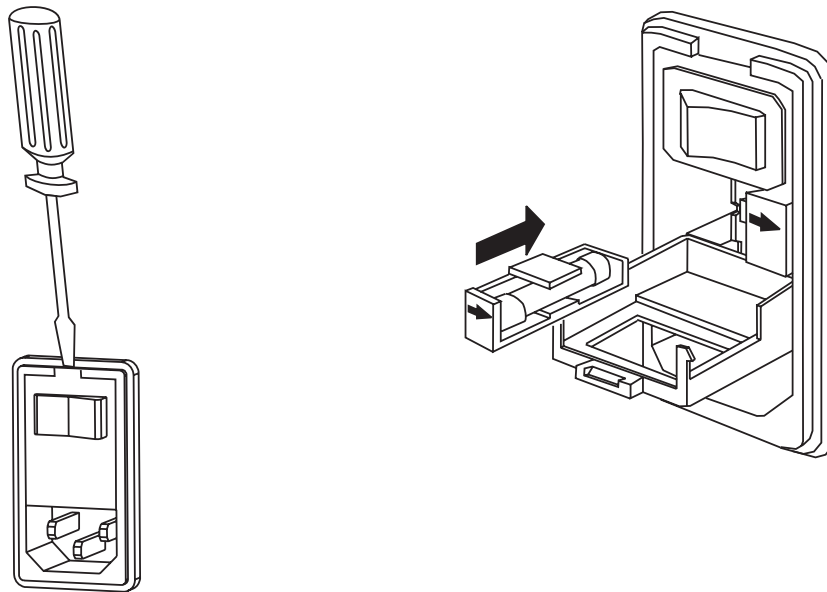

- Extract the fuse holder.
- Replace the fuses (for recommended fuses, see the label located above the main power switch).
- Close the fuse holder cover.
- Connect the power cord.

Note: For other maintenance operations please contact your dealer or the nearest Hanna Customer Service Center.

8.4 Peripherals

Warning! Connection/disconnection of POWER CORD, PUMP ASSEMBLY, EXTERNAL PC DISPLAY, PRINTER, RS232 INTERFACE or EXPANSION DEVICE must be done only when titrator and external devices are turned off.

The correspondence between the Titrator's Keypad and the United States 101-type external keyboard are:

External PC Keyboard

MAINTENANCE, PERIPHERALS

8.4.1 Connecting an External Display

The information shown on the titrator display can be viewed also on a Standard VGA display connected with a 15-pin cable, as presented below.

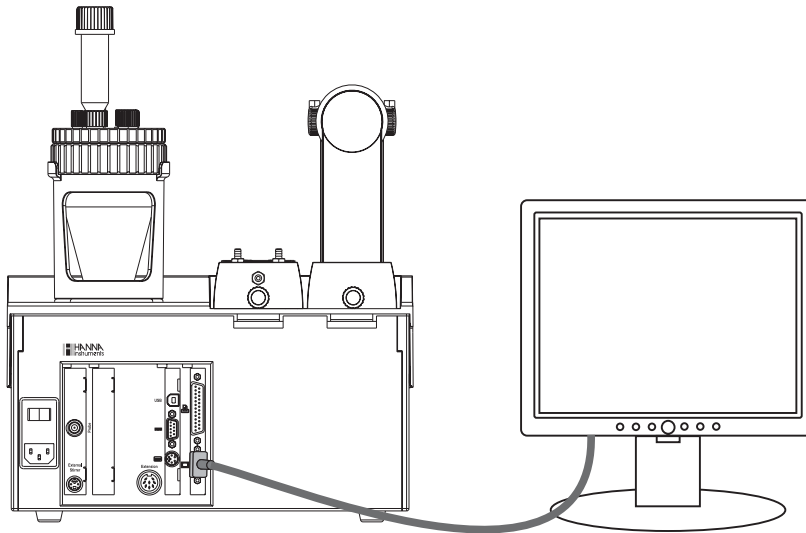

Connect the external display to the display socket.
Turn on the titrator and then the external display.





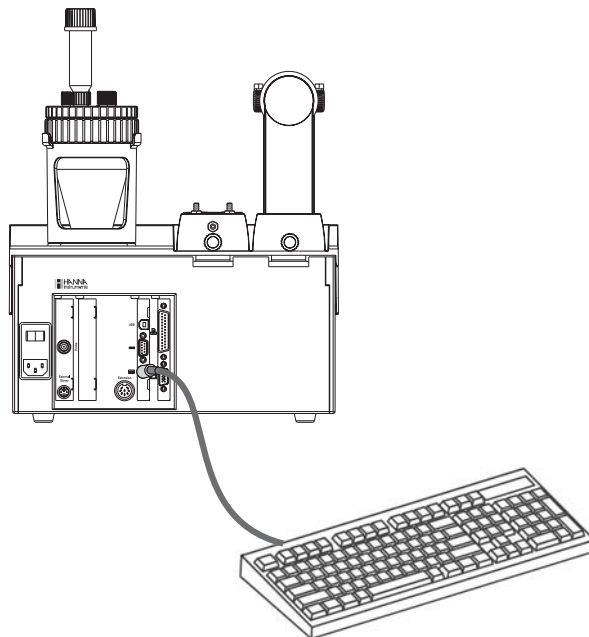









8.4.2 Connecting an External PC Keyboard

This connection allows you to use an external PS/2 PC Keyboard in addition to titrator's keypad.



Connect an external PC Keyboard (PS/2 connector).

MAINTENANCE, PERIPHERALS

(United States 101)	Titrator Keypad
Function Key F-1	
Function Key F-2	
Function Key F-3	
Function Key F-4	
Function Key F-5	Option Key 1 (from left to right)
Function Key F-6	Option Key 2 (from left to right)
Function Key F-7	Option Key 3 (from left to right)
Function Key F-8	Option Key 4 (from left to right)
Function Key F-9	Option Key 5 (from left to right)
Function Key F-10	
Arrow Key: Up	
Arrow Key: Down	
Arrow Key: Left	
Arrow Key: Right	
Page Up	
Page Down	
Numeric Keys: 0 to 9	
Tab	
Enter	
Home (access <i>General Options</i>)	
Alphanumeric Keys	Allow alphanumeric entries.

8.4.3 Connecting a Printer

A variety of parallel printers can be connected to the parallel port of the titrator using a standard DB25-pin cable.

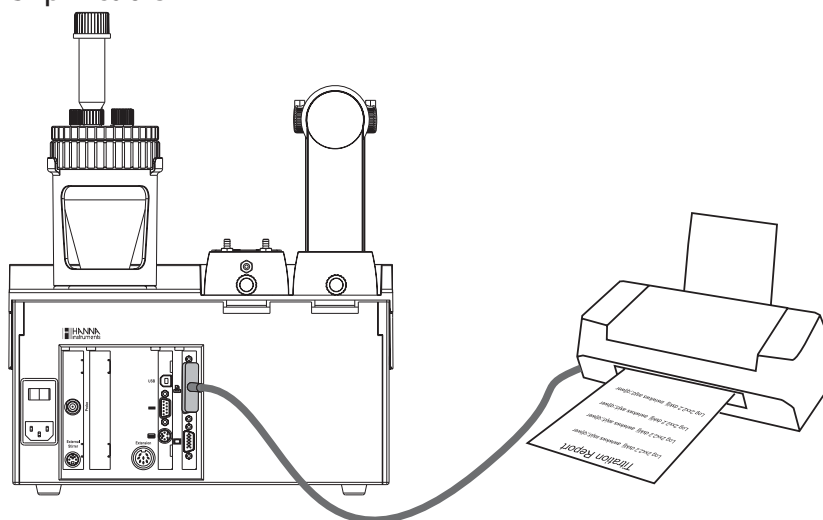

Warning: *The titrator and the external printer must both be OFF before they are connected.*

Connect the external printer to the standard 25-pin Socket.
Turn on the titrator and then the printer.

8.4.4 Connecting to a Computer

The titrator can be connected to a computer using a USB cable. HI 900 PC application needs to be installed on the PC.

Connect the cable to the USB port on the rear panel of the titrator.

Connect the cable to the USB port on the PC.

Select the **USB Link with PC** screen on the titrator by following the path:

General Options - USB Link with PC

Launch the HI 900 PC application and then select the appropriate USB port on the PC.

The HI 900 PC application allows the transfer of files (methods and reports) between titrator and PC.

Chapter 9. Contents

9	OPTIMIZATION	9 - 3
9.1	Titrator Settings	9 - 3
9.1.1	Control Parameters.....	9 - 3
9.1.1.1	Endpoint Potential and Polarization Current	9 - 3
9.1.1.2	Dosing Parameters	9 - 4
9.1.1.2.1	Minimum Dose	9 - 4
9.1.1.2.2	Maximum Dose	9 - 4
9.1.1.3	Timed Increment	9 - 5
9.1.1.4	Start Mode	9 - 6
9.1.1.5	Signal Averaging	9 - 6
9.1.1.6	Flow Rate	9 - 6
9.1.2	Termination Parameters	9 - 6
9.1.2.1	Stability Time	9 - 6
9.1.2.2	Drift Stop Termination Criteria	9 - 6
9.1.2.2.1	Relative Drift Stop	9 - 7
9.1.2.2.2	Absolute Drift Stop	9 - 7
9.1.3	Method Options	9 - 8
9.1.3.1	Pre-Dispensing Amount	9 - 8
9.1.3.2	Pre-Analysis Stir Time	9 - 8
9.1.3.3	Stirring Speed	9 - 8
9.1.3.4	Background Drift Rate Entry	9 - 8
9.2	The Sample	9 - 9
9.2.1	Proper Sampling Procedure	9 - 9
9.2.2	Determining the Optimal Sample Size	9 - 9
9.2.3	Solid Samples	9 - 10

METHODS OPTIMIZATION

9.2.4 Liquid Samples	9 - 11
9.2.5 Sample Preparation Techniques	9 - 12
9.2.5.1 Internal Extractions	9 - 12
9.2.5.2 Dilutions	9 - 12
9.2.5.3 External Dissolution	9 - 13
9.2.5.4 External Extractions.....	9 - 13
9.2.5.5 Homogenization	9 - 14
9.2.5.6 Heating.....	9 - 14
9.3 Karl Fischer Reagent System.....	9-15
9.3.1 Reagent System Classification	9 - 15
9.3.1.1 One-Component Reagent Systems	9 - 15
9.3.1.2 Two-Component Reagent Systems	9 - 15
9.3.1.3 Reagents for Aldehydes and Ketones	9 - 15
9.3.2 Choosing and Modifying a Solvent	9 - 16
9.3.3 Water Standards	9 - 16
9.3.4 Standardizing the Titrant	9 - 17

9 OPTIMIZATION**9.1 Titration Settings**

The default settings included with the standard methods have been developed by Hanna Instruments in order to provide accurate results for the majority of samples without requiring additional analyst input or method fine-tuning. However, in order to suit a wider variety of sample types and matrices, all of the **HI 903** titration parameters are customizable.

This section provides the descriptions of critical titration parameters necessary for an analyst to modify a standard method or develop a titration method from scratch.

HI 903 methods can be modified and customized based on the requirements of the sample, sample matrix and the Karl Fischer reagent formulation. The user changeable settings are separated into two categories: Control Parameters, which set critical functions that determine the course of a titration and set the way in which titrations are terminated, and Method Options, which control lesser features not directly affecting measurements and primarily allow advanced users to shorten titration times.

9.1.1 Control Parameters**9.1.1.1 Endpoint Potential and Polarization Current**

The **HI 903** uses the polarized electrode system known as bivoltametric indication. The titrator monitors the voltage required to maintain a constant polarization current (I_{p0}) between the pins of a dual platinum-pin Karl Fischer electrode during the course of a titration.

During a titration, no excess iodine is present. In order to maintain the set polarization current the **HI 903** must apply a relatively large voltage across the pins of the electrode.

At the endpoint of the titration, the amount of iodine added is equal to the amount of water from the sample. When an excess of titrant has been added, iodine is present in the solution. The excess iodine is easily reduced, and the resulting iodide is easily oxidized in electrode reactions at the cathode and anode respectively. The ease of these reactions make maintaining the constant polarization current possible at a much lower electrode potential.

In theory, a large shift in the electrode potential indicates the endpoint. In practice, a titration endpoint is reached when the electrode potential drops below a value defined by the user and the chosen termination criteria is met.

The choice of endpoint potential should be based, foremost, on the polarization current and, to a lesser extent, on the composition of the Karl Fischer solvent and the sample matrix. If the polarization current is changed, the endpoint potential must also be changed. In addition, there are pitfalls to be avoided when choosing an endpoint potential. Selecting endpoints which are both 'too high' or 'too low' will result in long titration times and poor reproducibility. Endpoints which are 'too high' are those which result in endpoints that either precede or coincide with equivalence point such that the concentration of excess iodine is not reliably detected. Endpoint potentials are considered 'too low' when they correspond to a large excess of iodine in the titration cell.

METHODS OPTIMIZATION

The table that follows correlates endpoint potential ranges for each of the possible polarization current settings of the HI 903. The suggested endpoints below are applicable for reagents formulated with methanol. Endpoint potentials should be increased by 20 to 25% when titrating with reagent systems formulated for use with aldehydes or ketones or where methanol has been replaced with higher alcohols or substituted ethers like diethylene glycol monoethyl ether or 2-methoxyethanol.

Polarization Current	1 μ A	2 μ A	5 μ A	10 μ A	15 μ A	20 μ A	30 μ A	40 μ A
Endpoint Potential	20 to 30 mV	25 to 35 mV	50 to 70 mV	80 to 100 mV	90 to 110 mV	100 to 120 mV	130 to 150 mV	150 to 170 mV

Additionally, the duration of a titration is proportional to the polarization current. Thus, titration time can be reduced by increasing the polarization current. While the default I_{pol} value of 20 mA results in the faster titration than smaller 1, 2, 5, 10, and 15 mA options a further increase to 30 or 40 mA does not significantly shorten a titration. However, the choice of higher polarization currents will speed contamination of the electrode and potentially degrade samples using special solvent systems.

9.1.1.2 Dosing Parameters

The **HI 903** predicts the approaching endpoint and reduces the volumes of titrant added until the endpoint is reached. This is a software controlled process known as dynamic dosing. Dynamic dosing prevents the addition of titrant beyond the endpoint and provides enhanced data density in the vicinity of the endpoint resulting in accurate endpoint determination and faster titrations. The minimum and maximum dose volume must be set appropriately by the user for dynamic dosing to be effective.

9.1.1.2.1 Minimum Dose

Decreasing the minimum dose increases precision but lengthens the titration time. The only exception is when stability time has been selected as the termination criteria and there is a high drift rate. Under these circumstances, the minimum dose must be large enough to maintain the endpoint potential by reacting all of the water due to the drift rate over the course of the chosen time period. Increasing the minimum dose shortens titration time but reduces precision and increases the chance of overtitration.

9.1.1.2.2 Maximum Dose

The maximum dose volume should be adapted according to the formulation and concentration of the titrant. The maximum dose volume should be set as high as possible without exceeding the reaction rate of the reagent system. The table below provides suggested maximum doses for popular reagent systems based on their relative reaction rates.

The most effective way to optimize the maximum dose volume is to consider the titration duration and to examine the shape of the titration curve. In the case where the maximum dose volume is too high, the iodine will be added faster than the titration reaction rate. This

excess iodine will result in a steep drop in electrode potential which will be interpreted by the **HI 903** as an approaching endpoint. This will in turn result in the dynamic dosing algorithm reducing the dose size until the excess iodine has time to react. The reduced dose size effectively interrupts the titration and adds considerable time to the titration duration. The titration will be interrupted repeatedly in this way such that the overall titration time is longer, even though the value of the maximum dose size is set to a large volume. The

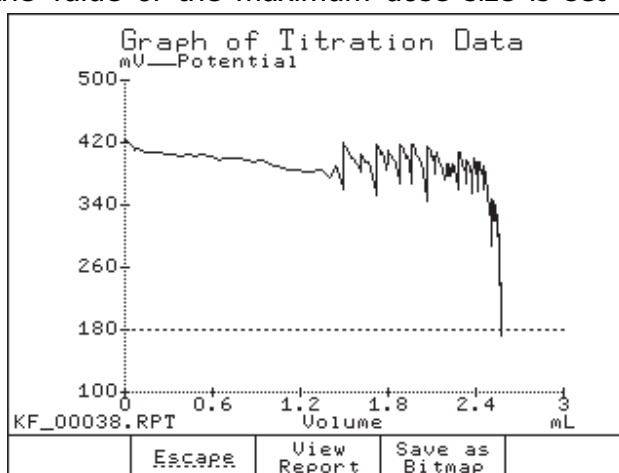

resulting titration curve will show:

Because reaction rates are faster with two-component reagents than those observed with one-component reagents the maximum dose volume can be set slightly higher when using two-component systems. In the case where the maximum dose is too low, titration time will be extended.

Karl Fischer Reagent System	Maximum Dose Volume
One-Component Systems	20 to 30 μ L
One-Component Systems for aldehydes and ketones	20 to 25 μ L
One-Component Systems formulated with pyridine	15 to 20 μ L
Two-Component Systems	40 to 60 μ L
Two-Component Systems formulated with pyridine	25 to 30 μ L

9.1.1.3 Timed Increment

This setting controls the amount of time between successive titrant doses.

Setting the time increment appropriately is important to ensure that the titrant has adequate time to mix with the sample such that the electrode measures a homogeneous solution before the titrator makes the decision on the size of the next dose of titrant.

The value of the timed increment is dependent on the type of reagent system being used. While the default value of 1 second is compatible for use with any reagent system, titrations using two-component reagent systems can be expedited by decreasing the time between successive doses.

METHODS OPTIMIZATION

9.1.1.4 Start Mode

The **HI 903** can be set to either normal or cautious start mode. The cautious start feature is designed to prevent the accidental over-titration of a sample with very low water content. In cautious start mode, the HI 903 starts a titration using the minimum dose size specified by the user rather than starting with half of the maximum dose size as with normal start mode.

9.1.1.5 Signal Averaging

The chosen value for the signal averaging setting determines how many readings the electronics will average to produce a single data point on the titration curve. While higher values of 3 or 4 readings reduce the response time of the electrode, they also result in a 'smoother' titration curve which may result in a faster titration (single unstable readings may cause the dose size to be reduced).

9.1.1.6 Flow Rate

The flow rate setting specifies the volume of titrant delivered per minute. The default flow rate should be used for the majority of titrations. In cases where the titrant is more viscous, the flow rate can be reduced.

9.1.2 Termination Parameters

HI 903 provides a choice of three criteria by which a titration can be considered to have reached an endpoint successfully.

9.1.2.1 Stability Time

When this termination criteria is selected, a titration is considered to have reached an endpoint when the electrode potential stays below the specified endpoint potential for a period of time called the stability time. Typical endpoint stability times range between 5 and 15 seconds.

In order for this criteria to successfully terminate a titration the stability time and the minimum dose size must be set such that, at the end of a titration, the minimum dose size is large enough to react all of the water leaking into the cell due to drift during the set stability time. If the minimum dose volume is too small to compensate for the water introduced by the drift, the titration will never be terminated.

9.1.2.2 Drift Stop Termination Criteria

Drift-based termination criteria, or Drift stop, terminates titrations based on the idea that at the end of a titration, when all of the water due to the sample has been reacted, the titrator should only be titrating the water seeping into the cell due to the background drift rate (see section 6.3 for a detailed explanation of background drift).

Ideally, drift stop termination criteria would end a titration when a drift rate identical to that which preceded the start of a titration is observed at the end of a titration. However, from a practical standpoint the achievement of an identical drift rate results in very long titration times.

In order to shorten titration times while still taking advantage of the positive aspects of

drift-based termination, the HI 903 incorporates two drift stop termination criteria which terminate titrations when the drift rate passes below a specified threshold. The methods can be distinguished by the way in which the drift rate thresholds are specified.

9.1.2.2.1 Relative Drift Stop

The relative drift stop termination parameter should be the first choice termination criteria. It is the most universally applicable, easiest to use and results in fast, repeatable titrations. This parameter has the advantage over other termination criteria in that the relative drift rate termination value can be set independently from the titrant concentration and the initial drift rate.

Under this criteria a titration reaches an endpoint successfully when the **HI 903** titrates all of the water introduced with the sample and maintains a drift rate which is equal to the sum of the initial drift (drift rate when the titration was initiated) and the set 'relative drift stop' value (i.e. a slightly higher drift than the initial drift rate).

The choice of relative drift stop value influences the titration duration and reproducibility. Choosing low relative drift stop values (5 to 10 $\mu\text{g}/\text{min}$) will result in titrations with high reproducibility and long durations. Setting high relative drift stop values (20 to 30 $\mu\text{g}/\text{min}$) will result in fast titrations with potentially reduced reproducibility. Reduced reproducibility at higher drift stop values is of particular concern when using reagents that have slower reaction rates (one-component or aldehyde and ketone reagents).

It is important to set an appropriate relative drift stop value when working with insoluble or sparingly soluble samples. During these types of titrations, the final traces of water are released very slowly. If the sample contains a small amount of water (the final traces are a large fraction of the total water), the relative drift stop value should be set very low. If the final traces can be ignored because the sample water content is large, then the titrations can be terminated at a higher drift rate termination value.

9.1.2.2.2 Absolute Drift Stop

Under this criteria, a titration reaches an endpoint successfully when the drift falls below a predefined threshold called the absolute drift stop value.

The absolute drift stop value does not take the initial drift rate into account but does have the advantage of being able to be set without consideration of the titrant concentration. In addition, for a titration to reach endpoint, the absolute drift stop threshold must be set higher than the initial drift rate value.

The primary disadvantage associated with the absolute drift rate termination criteria is that the actual background drift rate must be considered before setting the absolute drift rate threshold.

When setting the absolute drift threshold, a balance must be struck between the titration speed and accuracy. Choosing a threshold slightly higher than the initial drift rate will result in high reproducibility and relatively slow titrations. Setting the threshold higher ($>30 \mu\text{g}/\text{min}$) will result in very fast titrations and reduced titration reproducibility.

METHODS OPTIMIZATION

9.1.3 Method Options

9.1.3.1 Pre-dispensing Amount

It is possible to shorten titration times by adding a large fraction of the titrant at the start of the analysis if the approximate water content of the sample is known.

When activated, the pre-dispensing amount can be set to deliver between 1% and 90% of the titrant required to reach the titration endpoint.

A high pre-dispensing amount (around 90%) increases the chances of erroneous results. Pre-dispensing amounts above 50% should only be used if the reaction is very rapid.

9.1.3.2 Pre-analysis Stir Time

When analyzing solid samples with limited solubility or release bound water slowly, the sample must be stirred in the chosen solvent prior to the start of a titration, to avoid erroneously low titration results or unreachable endpoints. The pre-analysis stir time option ensures that after the sample is added the titration mixture is stirred for a period of time before any titrant is added to the cell. The pre-analysis stir time can be set between 0 and 1000 seconds.

9.1.3.3 Stirring Speed

The **HI 903**'s stirring speed can be set between 200 and 2000 RPM with 100 RPM resolution. The stirring system is equipped with an optical feedback mechanism to ensure that the stirring motor is rotating at the speed set by the user.

The optimum stirring speed is obtained when a small vortex is visible. If the stirring speed is too low, the titrant will not react with the sample before reaching the electrode resulting in over-titration and poor titration reproducibility. If the stirring speed is too high, bubbles will form in the solution. Bubbles can destabilize or falsify the measured electrode potential.

The default stirring speed for commercially available standard Karl Fischer reagents used within the operable volume range of the standard Hanna Instruments cell and with the supplied magnetic stirring bar is 900 RPM. Samples which result in a titration solution with higher or lower viscosity may require stir speed adjustment.

9.1.3.4 Background Drift Rate Entry

This option provides a choice between the **HI 903**'s automatic drift rate determination and assigning a fixed value to be used by the titrator as the drift rate.

The primary benefit of bypassing the automatic drift rate feature is saving time. This is appropriate when titrating samples with high water content where the drift rate is too low to affect titration results or in diagnostic situations where there is no advantage in waiting for the **HI 903** to conduct a drift rate analysis.

9.2 The Sample

9.2.1 Proper Sampling Procedure

Proper sampling is essential for accurately determining the water content of bulk materials, particularly with non-homogeneous samples. Many standard methods detail instructions to ensure proper sampling. As a general rule, the following guidelines should be followed:

1. The sample must be representative. The water content of the sample taken is the same as the average water content of the bulk material.
2. Avoid exposing samples to the contaminating effects of atmospheric moisture. Take samples as quickly as possible and protect the sample during transport and/or storage.
3. Take samples from the interior of bulk materials. Surfaces of hygroscopic materials may contain higher levels of moisture relative to the rest of the material. Surfaces of materials which release water may contain less water relative to the rest of the material.
4. Taking large samples of bulk materials will result in a more representative sample.

9.2.2 Determining the Optimal Sample Size

The proper choice of sample size is critical to achieving accurate and repeatable titration results. As a general rule, the sample size should be selected such that about 30-70% of the burette volume is consumed during a titration. This provides enough titrant to ensure good accuracy while conserving reagents and minimizing the generation of waste.

The table below illustrates the relationship between titration reproducibility, the volume of titrant consumed during a titration, the amount of water contained in a sample, the size of a

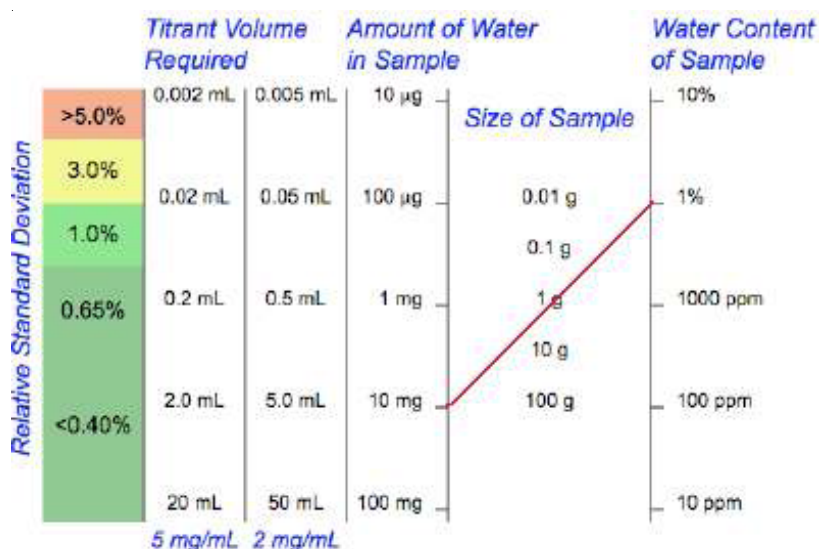

METHODS OPTIMIZATION

sample and the water content of a sample.

The ideal sample size can be estimated using the table by drawing a line from the expected water content to the amount of water in the sample corresponding to the desired titration reproducibility (relative standard deviation). The ideal sample size is indicated by where the drawn line intersects the 'size of sample' scale.

Consider the line on the table as an example. The line was drawn for a user with a sample having approximately 1% water who required the best possible reproducibility. The intersection of the red line with the size of sample column indicates that in order to introduce the optimal 10 mg of water into the titration cell the user must add 1g of sample.

The amount of sample required to introduce 10 mg of water into the titration cell can also be calculated directly using the equation below.

$$\text{Sample mass (g)} = \frac{1}{\% \text{ H}_2\text{O in sample}}$$

9.2.3 Solid Samples

Sample water must be available to react with the titrant. This typically means that the sample must be adequately dissolved in the solvent. This is achieved by choosing an appropriate solvent system, proper preparation of the sample and optimization of the reaction conditions. After ensuring that the sample is soluble in the choice of solvent or solvent mixture, dissolution of a solid sample can be aided by grinding the sample into a fine powder, increasing the pre-analysis stir time or heating the solvent during a titration with an optional jacketed titration cell and water circulator.

Solid samples are added to the titration cell by removing the sample plug. The quantity of solid sample added can be entered into the **HI 903** as a mass or by number of pieces if, for example, pills are to be analyzed.

The most accurate way to determine the mass of the sample added to the cell can be achieved by an analytical technique called back-weighing. Back-weighing consists of the following steps:

1. Measure the mass of a sample in a weigh boat.
 2. Initiate the titration sequence on the HI 903 using the 'start analysis' option key from standby mode. This will bring up the 'add sample' screen.
 3. Slide the sample plug up out of the vessel top to open the sample port.
 4. Rapidly add the sample through the sample port ensuring that ALL of the sample is transferred to the solvent. Avoid any contact between the sample and the cell walls or top.
 5. Replace the sample plug into the vessel top.
 6. Determining the mass of the 'empty' weight boat.
 7. Calculate the mass of the sample added (subtract the mass of the emptied weigh boat from the mass of the full weigh boat).
 8. Enter the calculated mass of the sample into the **HI 903**.
 9. Start titration using the option key 'start analysis' from the add sample screen.
-

Care should be taken to add a solid sample as fast as possible in order to minimize the amount of time that the sample port is open. It is also important to be sure that all of the sample reaches the solvent and does not make contact with, or stick to, the inner sides of the vessel cap. Losing even a small fraction of the sample mass will result in a high sample water content.

In some cases solid samples may require one of the additional preparatory steps listed in the sections that follow. Specific sample preparation instructions are included with each standard method.

9.2.4 Liquid Samples

As with solids, the water contained in liquid samples must be available to react with the titrant. It is important to select a solvent system or mixture with which the sample is miscible. Liquids are typically added through the septum in the sample port via a syringe and needle using the following steps:

1. Attach a long needle (approximately 6 cm long, 21-gauge) to a syringe large enough to hold at least one complete sample volume.
2. Rinse the syringe and needle with sample several times by drawing in a small portion of sample, fully extending the plunger, shaking to coat the syringe interior and expelling the sample into a waste collection container.
3. Draw enough sample into the syringe for at least one titration.
4. Dry the outside of the needle with a lint free wipe or tissue.
5. Determine the mass of the syringe and sample.
6. Initiate a titration from standby mode by pressing the 'start analysis' option key.
7. Insert the needle through the septum in the sample port. Push the syringe through the septum until the end of the needle is approximately 1 cm from the surface of the solvent.
8. Steadily dispense the contents of the syringe ensuring that the sample is introduced directly into the solvent and does not splash or spatter onto the wall of the titration vessel electrode or dispensing tip.
9. Draw a small amount of air from inside the cell into the syringe to ensure that no sample drops remain on the tip of the needle.
10. Remove the syringe and needle from the septum taking care to not touch the needle to the solvent or other internal cell components.
11. Determine the mass of the syringe and needle.
12. Calculate the mass of the sample added to the titration cell (subtract the mass of the syringe after the sample has been added from the mass of the syringe before sample addition).
13. Enter the calculated mass of the sample into the **HI 903**.
14. Start titration using the option key 'start analysis' from the add sample screen.

As indicated above, when adding a liquid sample with a needle and syringe, it is important that the sample is introduced directly into the solvent. Sample that is deposited on the sides of the

METHODS OPTIMIZATION

vessel or other internal components of the cell may not be titrated with the rest of the sample. It is equally important that no drops remain on the tip of the needle. 'Hanging drops' will end up on the bottom of the septum. This will result in false low results for the determination.

Liquid samples with high viscosity like honey can be added via a syringe without needle through the sample port following the steps outlined above.

In some cases liquid samples may require one of the additional preparatory steps listed in the sections that follow. Specific sample preparation instructions are included with each standard method.

9.2.5 Sample Preparation Techniques

While many samples can be introduced directly into the titration vessel (see section 6.5 *Sample Addition*), others require preparatory steps. It is critical that samples are not contaminated with additional water or lose water during the preparation phase.

The steps required for the most common sample preparation techniques are outlined below. For detailed application-specific instructions, consult the instructions included with applicable standard methods.

The **HI 903** provides options for the automatic calculation of samples prepared normally, using external extraction and external dissolution.

9.2.5.1 Internal Extractions

Internal extractions are carried out using the 'normal' sample type option within the 'sample parameters menu'. This type of sample preparation is suitable for solid samples which release their water relatively quickly (during the pre-analysis stir time) and exhibit limited or no solubility in Karl Fischer solvents. Internal extraction should be used preferentially over external extraction techniques because the extracted water is titrated immediately, which favors complete extraction by Le Chatlier's principle.

An outline of the general procedure follows:

1. Add methanol or an appropriate solvent to the titration cell and pre-titrate to dryness.
2. Adjust the pre-analysis stir time to be sufficiently long enough to complete the extraction. Appropriate set times will be sample and solvent specific. Consult an applicable standard method or experiment by increasing the pre-analysis stir time and titrating samples until the resulting water content no longer increases.
3. Reduce the samples to as fine of a powder as possible to ensure that sample water is extracted quickly.
4. Add the sample to the titration vessel using the back weighing method.

9.2.5.2 Dilutions

It is very difficult to accurately add very small amounts of sample to the titration vessel. In order to produce accurate and reproducible results, samples having water content greater than 50% should therefore be diluted with a dry solvent before being introduced into the

titration vessel. Dilutions are carried out using the 'external dissolution' sample type option. Anhydrous methanol is the solvent of choice for sample dilutions. If the sample contains fats or oils, then a mixture of methanol and chloroform can be used to promote solubility of the sample.

The following outlines a generic dilution procedure:

1. Determine the mass of a dry flask equipped with a septum stopper.
2. Transfer approximately 1 g of sample to the flask and measure the mass of the flask and the sample together.
3. Add 30 grams of dilution solvent to the flask. Re-seal and mix the flask contents.
4. Determine the moisture content of the dry solvent used as the diluent in a separate titration.
5. Add the diluted sample as per the instructions for adding liquid samples in this section.

9.2.5.3 External Dissolution

External dissolutions are recommended for titrations which require a large amount of soluble solid sample due to inhomogeneous water distribution or very low water content. External dissolution reduces the error typically associated with the titration of low water content solids by collecting the water released by a large amount of solid sample by dissolving it in a relatively small amount of solvent. A small portion of the solvent can then be injected into the titration vessel.

Sample preparation and choice of solvent or solvent mixture is sample specific. Consult an applicable standard method for procedural details.

The **HI 903** will conduct the necessary calculations automatically when 'external dissolution' is selected from the sample type menu.

9.2.5.4 External Extraction

External extraction is recommended for insoluble solid samples which release water slowly.

The **HI 903** will conduct the necessary calculations automatically when 'external extraction' is selected from the sample type menu.

An outline of a general procedure follows:

1. Determine the mass of an extraction bottle or flask equipped with a septum.
2. Add the extraction solvent to the bottle and determine the mass of the bottle and the solvent. In order to maximize the effectiveness of the extraction, the water content of the solvent should be as low as possible. When choosing an extraction solvent, one must carefully consider the limit of water saturation for a possible solvent.
3. Determine the water content of the solvent.
4. Determine the mass of the solvent remaining in the extraction bottle.
5. Add a finely crushed sample to the solvent in the extraction bottle. The amount of sample added should be large enough so that the amount of water in the sample is much greater than that in the solvent before the extraction.

METHODS OPTIMIZATION

6. Facilitate extraction by shaking the solution or placing the solution on a stirring plate or in a sonicator.
7. Allow the insoluble portion of the sample to settle to the bottom of the extraction bottle.
8. Titrate an appropriately sized sample of the supernatant (solvent above the settled solid sample).

9.2.5.5 Homogenization

Homogenization is recommended for non-aqueous or mixed phase liquid samples as well as solids with inhomogeneous distributions of water. Water can be evenly distributed throughout a collected sample by the use of high speed, high shear mixers called homogenizers.

In mixed phase (oil and water) non-aqueous samples, water tends migrate to the surface of the sample solution, adhere to the inner walls of or sink to the bottom of the sample bottle. This is particularly problematic when sampling is done at high temperatures and the specimen is subsequently allowed to cool to room temperature prior to analysis.

Solid samples typically exhibit inhomogeneous water distributions and must therefore be thoroughly reduced to powder or homogenized. The procedure for homogenization depends upon the characteristics of the specific sample.

Homogenization is particularly suited for semi-solid samples and suspensions and is the only method that can disrupt plant and tissue cells in order to release water present inside the cells. Homogenization is typically carried out externally in a dry flask with the addition of a suitable solvent, preferably methanol.

9.2.5.6 Heating

Sample heating is used for the analysis of solid or liquid samples that cannot be extracted or that interfere with the Karl Fischer reaction. These include plastics, minerals, petrochemical products which contain additives, and starting materials for pharmaceutical products.

Samples are heated in a special oven while a dry stream of carrier gas passes through the sample chamber or, for liquid samples, the sample itself. The carrier gas is introduced into the titration vessel.

The heating temperature is sample specific and can be found in applicable standard methods. The temperatures are chosen to be as high as possible without decomposing the sample, which can result in contamination of the titration vessel.

9.3 Karl Fischer Reagent System

A wide variety of Karl Fischer reagents exist on the market today, each designed and formulated for specific sample matrices and titration conditions. Karl Fischer reagent systems consist of a solvent and a titrant. The solvent is the liquid to which the sample is added in the reaction vessel. The titrant is the iodine-containing liquid pumped into the cell during the titration.

9.3.1 Reagent System Classification

Reagent systems are classified as either one-component or two-component depending on whether the sulfur dioxide and base are included in the titrant or with the solvent. In one-component systems, also known as composites, the titrant contains all of the reactants needed to conduct the titration (iodine, sulfur dioxide and a base) dissolved in an alcohol or ether. In a two-component reagent system, the solvent already contains the sulfur dioxide and the base while the titrant is typically a solution consisting of iodine and methanol.

9.3.1.1 One-Component Reagent Systems

One-component reagents are less stable than two-component systems, typically having only a two-year shelf life, but they provide several significant advantages. The major advantage is that the titrant is providing the sulfur dioxide and the base. The constant supply of reaction components from the titrant allows a high level of flexibility with respect to the chemical composition of the solvent and provides a nearly limitless solvent capacity for water. One-component solvent systems can be easily customized, creating mixtures specially adapted to specific sample characteristics without having to worry about providing appropriate levels of sulfur dioxide and buffer components. Common solvent mixtures include ethanol, chloroform, xylene, toluene, and long chain alcohols such as hexanol and decanol.

9.3.1.2 Two-Component Reagent Systems

Two-component reagents have advantages of their own. They are more stable and have a longer shelf life than one-component systems. The sulfur dioxide is pre-mixed in excess with an alcohol-based solvent, therefore the necessary reactive sulfite esters are present in vast excess prior to the start of a titration. This results in higher titration speeds and greater accuracy for low levels of water. In addition, having the base present in excess in the solvent prior to sample addition results in a higher solvent buffer capacity.

9.3.1.3 Reagents for Aldehydes and Ketones

The addition of a sample containing aldehydes or ketones to a methanol-based Karl Fischer solvent results in side reactions that adversely affect titration results. When alcohols react with the carbonyl groups of aldehydes and ketones they form acetals and ketals via a reaction that releases water. The generation of water during a titration will falsely inflate water content results and could lead to vanishing endpoints.

While ketones are less reactive than aldehydes, the reactivity of both species is inversely

METHODS OPTIMIZATION

proportional to carbonyl chain lengths. The formation of acetals and ketals is also dependent on the type of alcohol included in the solvent. As the chain length of an alcohol's alkyl or substituted alkyl group increases, the alcohol's reactivity toward ketones and aldehydes decreases (i.e. methanol is the most reactive).

Acetal or ketal formation can be prevented by the use of methanol-free reagents specially produced for this purpose. Reagents for aldehyde and ketone analysis replace methanol with higher alcohols, ethers, halogenated alkanes or similar combinations.

9.3.2 Choosing and Modifying a Solvent

The solvent plays an important role in the KF titration. It must react with sulfur dioxide to form the reactive methyl sulfite species, dissolve the sample and/or extract water, and it should help prevent side reactions from occurring. The most common solvent is methanol. Co-solvents can be added to increase sample solubility in one-component solvents, as long as the mixture contains at least 20 - 30% methanol. In a two component reagent system, 50% solvent for two component system and 50% co-solvent can be used. This ensures that there is enough sulfur dioxide and base for the Karl Fischer reaction to take place.

In general a solvent should be chosen in accordance with the sample composition:

Fats, oils and long-chain hydrocarbons have limited solubility in methanol. Co-solvents of long-chain alcohols (n-decanol) or chloroform should be used;

Carbohydrates and proteins have poor solubility in methanol, formamide can be used as a co-solvent;

Analyzing acids or bases may take the pH outside the optimal range and additional buffering may be required; a commercial Karl Fischer 'Buffer' reagent can be added or extra imidazole can be added for acid samples and salicylic acid can be added to the solvent for basic samples; For analysis of ketones or aldehydes, the methanol can be replaced with special "K" reagents that contain mixtures including 2-chloroethanol, chloroform, ethanol or 1-methoxy-2-propanol.

9.3.3 Water Standards

Water standards are used to standardize the titrant and to verify the titrator's performance and analyst technique. Water standards are an integral part of ISO 9000, GMP, GLP and FDA guidelines for water determination.

The most commonly utilized water standard for volumetric Karl Fischer titration is sodium tartrate dihydrate. Available as a highly-purified, non-hygroscopic powder, sodium tartrate dihydrate has a stable water content of $15.66 \pm 0.05\%$. The compound is, however, sparingly soluble in methanol requiring at least 3 minutes of stirring for complete dissolution.

If high precision or NIST traceability is required, water standards sealed in glass ampules are also commercially available. Although they are more expensive, sealed standards come pre-analyzed and certified by the manufacturer and are available in a wide range of concentrations.

The experienced analyst can also use very small volumes of deionized water as a standard.

Due to the very water-sensitive nature of a Karl Fischer titration, only a few milligrams of water are required for a typical standardization or system verification. A great deal of skill is therefore required in determining the mass of the water introduced into the titration vessel in order to achieve highly accurate results.

9.3.4 Standardizing the Titrant

Standardizing the Titrant, or determining the titer, is a routine and necessary part of accurate Karl Fischer analyses. The titrant should be standardized daily for greatest accuracy. Standardization serves to standardize the combination of parameters selected as part of a particular method and serve as a system check. It is recommended that the titrant be re-standardized if the method to be used for an analysis is very different from that which was used to standardize the titrant initially. The titrant can be standardized using hydrated salt, liquid water standards or tiny amounts of pure water.

A general procedure for titrant standardization:

1. Setup titrator according to the instruction manual. Ensure the titrator is set up with the same reagents, solvents, working conditions, temperature and titrator settings to be used for subsequent sample analyses.
2. Select the appropriate standardization method included with the **HI 903**.

Using a Sodium Tartrate Dihydrate Standard:

3. Back-weigh between 30 and 200 mg of standard. Be sure that the salt is a high quality standard, which has been stored properly and exists as a fine, free flowing powder.
4. Repeat the standardization at least three times and update the titrant concentration using the averaged result value via the statistics screen if the variability between the standardizations is small.

Using a Prepared Liquid Water Standard (Ampule):

3. Break open an ampule of standard. Rinse a syringe with a small portion of standard.
4. Draw up the remainder of the standard into the syringe, weight and titrate about one third of the standard in the syringe.
5. Conduct two more standardizations with the standard remaining in the syringe.
6. Review the set of results on the 'average results' statistics screen. The titrant concentration should be updated with the averaged results as long as there is not excessive variability between standardization results.

With pure water standards:

3. Draw approximately 10 μL of pure water into a glass micro-liter syringe.
4. Introduce the water standard by back-weighing using an analytical balance with 0.01 mg resolution. Because of the extremely small sample size, it is important to strictly follow the procedure for the addition of liquid samples outlined in the section 'addition of liquid samples' above.

METHODS OPTIMIZATION

5. Review the set of results on the 'average results' statistics screen. The titrant concentration should be updated with the averaged results as long as there is not excessive variability between standardization results.

Appendix 1. Contents

A1 TECHNICAL SPECIFICATIONS A1-3

A1 TECHNICAL SPECIFICATIONS

Range	100 ppm to 100%
Resolution	1 ppm to (0.0001%)
Result Units	%, ppm, mg/g, µg/g, mg, µg, mg/mL, µg/mL, mg/pc, µg/pc
Sample Type	Liquid or Solid
Determination	
Pre-Titration Conditioning	Automatic
Background Drift Correction	Automatic or User Selectable Value
Endpoint Criteria	Fixed mV persistence, Relative drift stop or Absolute drift stop
Dosing	Dynamic with optional pre-dispensing
Result Statistics	Mean, Standard Deviation

Clip-Lock™ Exchangeable Burette System

Dosing Pump	
Resolution	1/40000 of the burette volume (0.125 µL per dose)
Accuracy	± 0.1% of full burette volume
Syringe	5-mL precision ground with PTFE plunger
Valve	Motor-driven 3-way, PTFE liquid contact material
Tubing	PTFE with light block and thermal jacketing
Dispensing Tip	Glass, fixed position anti-diffusion
Titration Vessel	Conical with operating volume between 50-150 mL
Solvent Handling System	Sealed system, integrated diaphragm air pump.

Electrode

Type	Dual platinum pin, polarization electrode
Connection	BNC
Polarization Current	1, 2, 5, 10, 15, 20, 30 or 40 µA
Voltage Range	2 mV to 1000 mV
Voltage Resolution	0.1 mV
Accuracy	± 0.1%

Stirrer

Type	Magnetic, Optically regulated, digital stirrer
Speed	200- 2000 RPM
Resolution	100 RPM
External Stirrer	4-pin mini DIN Connection allows for the control of an external stirring apparatus

Peripheral Devices

PC	Transfer methods and reports via USB connection to a PC using the HI 900 PC Software
----	--

APPENDIX 1

USB Flash Drive	Methods and reports can be easily transferred between devices using a USB Flash Drive. Software upgrades are made easy.
Laboratory Analytical Balance	RS-232 to connect any laboratory balance
Printer	Parallel port is used to connect a printer which allows printing from the titrator
Monitor	Instrument status and titrations can be viewed on a larger screen using any VGA-compatible external monitor
Keyboard	Alphanumeric text can be entered using an optional PS/2 keyboard
Graphic Display	5.7" (320 x 240 Pixel) Color LCD
Power Supply	HI 903-01: 115 VAC, 50-60 Hz HI 903-02: 230 VAC, 50-60 Hz
Power Draw	HI 903-01: 0.2 Amps HI 903-02: 0.1 Amps
Fuses	2 Exchangeable Fuses
Languages	English, Portuguese, Spanish
Titration Methods	Up to 100 (standard and user) methods
Data Storage	Up to 100 complete titration reports and drift rate reports can be stored
GLP Conformity	Good Laboratory Practice and Instrumentation Data Storage and printing
Enclosure Material	ABS plastic and Steel
Keypad	Polycarbonate
Dimensions	Width x Depth x Height = 390 x 350 x 380 mm (15.3 x 13.8 x 14.9 in)
Weight	Approx. 22 lbs. (10 kg)
Operating Environment	10 to 40°C, up to 95% relative humidity
Storage Environment	-20 to 70°C, up to 95% relative humidity

Appendix 2. Recommended Reagents

A2	RECOMMENDED REAGENTS	A2-3
A2.1	Titration	A2-3
A2.1.1	1-component Titrants	A2-3
A2.1.2	2-component Titrants.....	A2-3
A2.2	Solvents	A2-3
A2.2.1	1-component Solvents	A2-3
A2.2.2	1-component Solvents	A2-4
A2.3	Standards	A2-4

A2 RECOMMENDED REAGENTS**A2.1 Titrants****A2.1.1 1-component Titrants**

Sigma-Aldrich®	34805 HYDRANAL® Composite 5
	34806 HYDRANAL® Composite 2
	34816 HYDRANAL® Composite 5K
	34827 HYDRANAL® Composite 1
GFS Chemicals®	1600 WaterMark® Pyridine-Free Single Solution, 5 mg/mL
	1601 WaterMark® Pyridine-Free Single Solution, 2 mg/mL
J.T. Baker®	8890 HYDRA-POINT™ Comp 5
	8891 HYDRA-POINT™ Comp 2

A2.1.2 2-component Titrants

Sigma-Aldrich®	34723 HYDRANAL® Titrant 2E
	34811 HYDRANAL® Titrant 2
GFS Chemicals®	1603 WaterMark® Stable, 2 mg/mL, Non-hygroscopic
	1604 WaterMark® Stable, 5 mg/mL, Non-hygroscopic
	1616 WaterMark® 5 mg/mL, in Methanol
	1970 WaterMark® Stable, 0.5 mg/mL, Non-hygroscopic
J.T. Baker®	8844 HYDRA-POINT™ Titrant 5
	8845 HYDRA-POINT™ Titrant 2

A2.2 Solvents**A2.2.1 1-component Solvents**

Sigma-Aldrich®	34697 HYDRANAL® Solver (Crude) Oil Working Medium
	34698 HYDRANAL® Medium K Working Medium
	34734 HYDRANAL® CompoSolver E Working Medium
	34738 HYDRANAL® KetoSolver Working Medium
	34741 HYDRANAL® Methanol Dry Working Medium
	34855 HYDRANAL® LipoSolver CM Working Medium

APPENDIX 2

A2.2.2 2-component Solvents

GFS Chemicals® 1609 WaterMark® Solvent, Methanol-Free
1610 WaterMark® Solvent, General Purpose

J.T. Baker® 8855 HYDRA-POINT™ Solvent G

A2.3 Standards

Sigma-Aldrich® 34803 HYDRANAL® Standard Sodium Tartrate Dihydrate
34828 HYDRANAL® Water Standard 1.00
34847 HYDRANAL® Water Standard 0.10
34849 HYDRANAL® Water Standard 10.0

GFS Chemicals® 2302 KF Water Standard, 1.0 mg/g

Appendix 3. Accesories

A3 TITRATOR COMPONENTS A3-3

A3 TITRATOR COMPONENTS

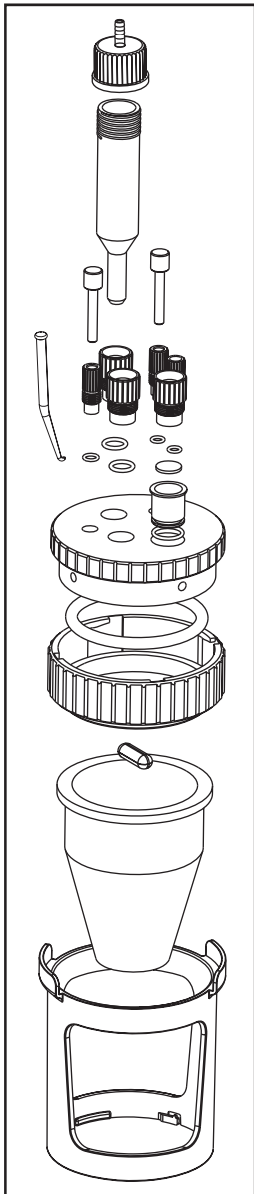

HI900520
Beaker Assembly

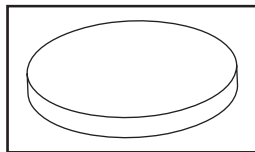

HI900527
Septum, 5pcs

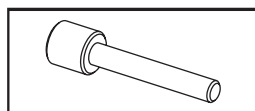

HI900528
Solvent Port Plugs, 2pcs

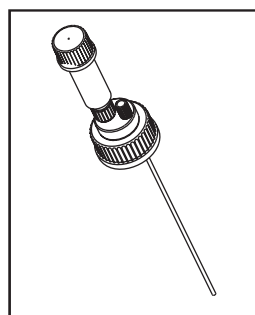

HI900530
Titrant Bottle Top
Assembly

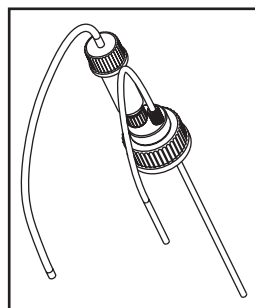

HI900531
Solvent/Waste Bottle Top
Assembly

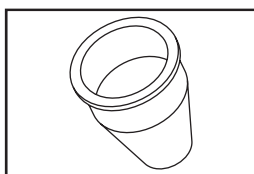

HI900522
Beaker for HI903

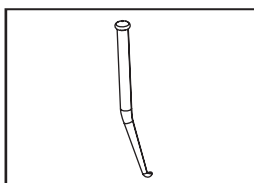

HI900523
Dispensing tip, 2pcs

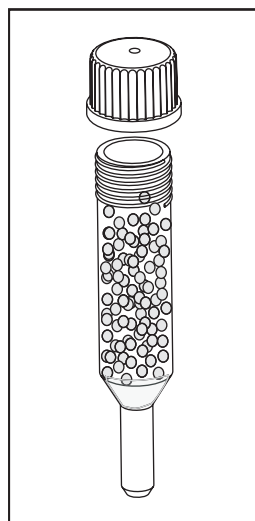

HI900532
Desiccant Cartridge for
Beaker or Titrant

APPENDIX 3

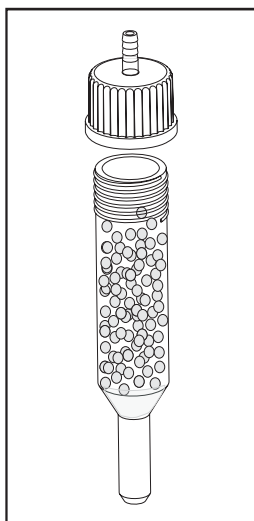

HI900533
Desiccant Cartridge for
Solvent or Waste

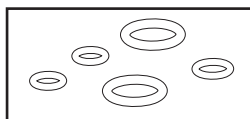

HI900540
O-Ring Set

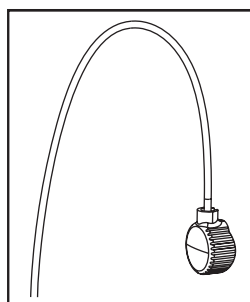

HI900570
Aspiration Tubing

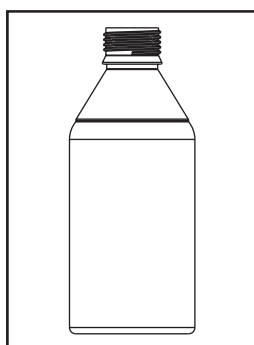

HI900534
Waste Bottle

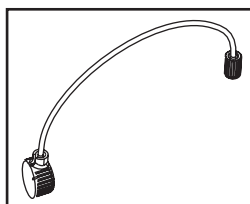

HI900580
Dispensing
Tubing and fitting

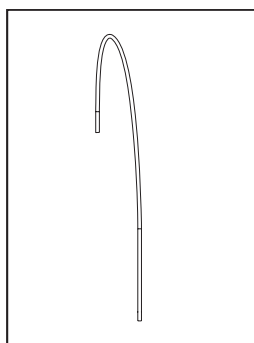

HI900535
2 x Tubing for Solvent/
Waste Handling

HI900536
2 x Tubing for Air Pump

- HI900550 Desiccant, 250 g
- HI900810 Manual (English) for HI 903
- HI900903U PC Application on USB Flash Drive
- HI900941 Calibration Key
- HI900942 Tool for Burette Cap Removal
- HI900943 Fuses, 1A (UL) x 2 pcs
- HI900944 Fuses, 2A (UL) x 2 pcs

MAN HI903
05/12

GENERAL APPLICATIONS BROCHURE

HI 903

KARL FISCHER VOLUMETRIC TITRATOR

Revision 1.00

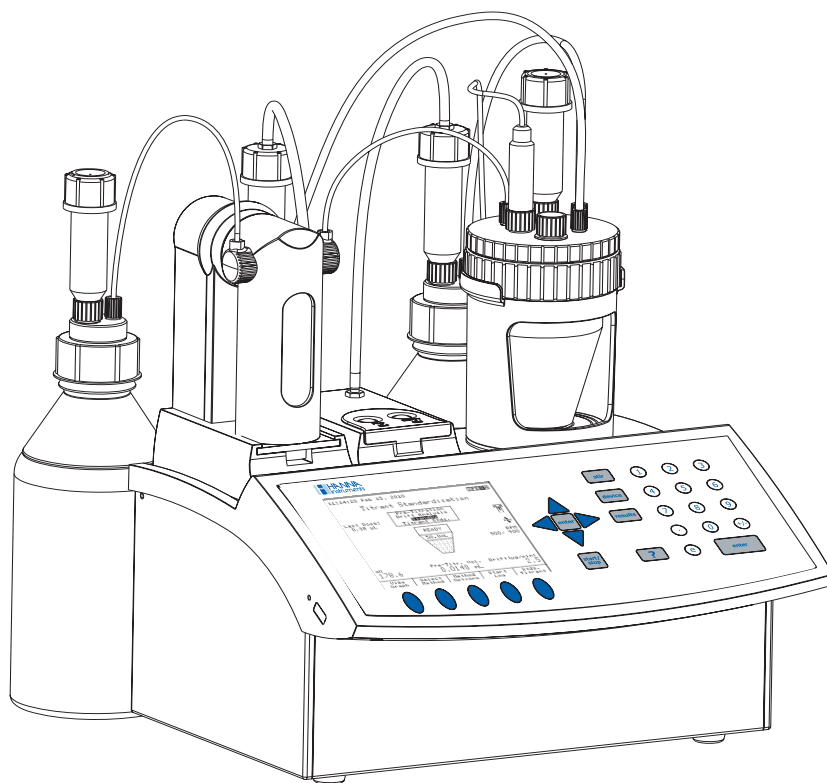

5.0 mg/mL Titrant Standardization using a Liquid Water Standard

for one-component titrant

Description:

Method for the standardization of 5.0 mg/mL One-Component Karl Fischer Titrant using a Liquid Water Standard. The results are expressed in **mg/mL**.

Electrode:

- HI 76320 Double Platinum Pin Electrode

Reagents:

- 5 mg/mL One-Component KF Volumetric Titrant
- 10 mg/g Liquid Water Standard
- Dry Methanol

Other Accessories:

- A clean, dry 3-mL syringe
- A clean, dry 22-gauge, 6" non-coring septum penetration needle
- GL 45-Thread Solvent Bottle

Procedure:

- Setup titrator according to the instruction manual.
- Press "*Select Method*" from the main screen. Use the arrow keys to highlight 'HI8001EN Stdz 5mg/mL w/ water Std.' and press "*Select*".
- Install a 5-mL burette filled with 5 mg/mL One-Component KF Volumetric Titrant to be standardized and verify that no air bubbles are present in the burette or tubing. If necessary prime until all air has been removed completely.
- Connect the solvent bottle top assembly to the bottle of methanol according to the manual.
- Prepare the titration vessel according to the manual. Dispense enough solvent from the solvent bottle to fill the vessel to the "min" line (about 50 mL).
- Press "Start/Stop" to pre-titrate the solvent and the titration vessel moisture. Allow the background drift rate to stabilize before proceeding to the next step.
- Fill the syringe and needle with the water standard.
- Weigh the syringe, needle and water standard.
- Press "*Start Analysis*". You will be prompted to enter the sample size.
- Dispense 1.00 g (about 1 mL) of standard into the titration vessel through the septum using the needle. Pay attention not to get any sample on the electrode or beaker walls. If necessary swirl the titration vessel by hand.
- Clear the needle of residual standard by intaking a small volume of air from the titration vessel. If a "hanging drop" of standard is seen on the end of the needle, dip the end of the needle briefly in the solvent.
- Remove the needle from the titration vessel and weigh the syringe again in order to determine the

added standard mass (by difference of the two measurements.)

- Use the numeric keypad to enter the exact weight and press "*Enter*" to start the analysis.
- At the end of the titration, the "Standardization Result" screen is displayed. The results are expressed in **mg/mL**.

Method Parameters:

Name:	Stdz 5mg/mL w/ water Std
Method Revision:	1.0
Type:	Titrant Standardization
Predispensing Amount:	25 %
Pre-Analysis Stir Time:	5 Sec
Stirring Speed:	900 RPM
Stirbar Type:	Medium
Drift Entry:	Automatic
Solvent:	Methanol
Standard:	Liquid 10 mg/g
Type:	Liquid by mass
Concentration Unit:	mg/g
Water Content:	10.0000 mg/g
Standard Size:	1.0000 g
Titrant:	Composite 5
Titrant Type:	One Component
Nominal Titrant Conc.:	5.0000 mg/mL
Std. Titrant Conc.:	5.0000 mg/mL
Date/Time:	Jan 1, 2011 12:00
Titrant Age Reminder:	2d:00h:00m
Control Parameters:	
Start Mode:	Normal
Standby Mode:	Enabled
Standby Duration:	720 minutes
Imposed Current:	20 uA
Minimum Dose:	0.500 uL
Maximum Dose:	20.000 uL
Timed Increment:	1 second
End Point Value:	180.0 mV
Signal Averaging:	3 Readings
Flow Rate:	10.0 mL/min
Termination Parameters:	
Maximum Duration:	1200 sec
Maximum Titrant Volume:	10.0000 mL
Term. Criterion:	Relative Drift
Relative Drift:	7.0 ug/min

Calculations:

Titrant units:	mg/mL
Titrant volume consumed:	V (mL)
Final Results Units:	mg/mL
Standard Concentration:	10.0000 mg/g
Standard mass:	1.0000 g

$$\text{mg/mL} = \frac{10.0000 \times 1.0000}{V}$$

5.0 mg/mL Titrant Standardization using a Liquid Water Standard for one-component titrant

Results:

Titration Report

Method Name: Stdz 5mg/mL w/ water Std.
Time & Date: 12:00 Jan 1, 2011
Standard Size: 1.0000 g
Standard Conc.: 10.0000 mg/g
Drift Value: 5.4 ug/min
End Point Volume: 2.0341 mL
Result: 4.9276 mg/mL
Titration Duration: 4:19 [mm:ss]
Estimated Cell Volume: 55.88 mL
Titration went to Completion
Operator Name:
Analyst Signature: _____

2.0 mg/mL Titrant Standardization using a Liquid Water Standard

for one-component titrant

Description:

Method for the standardization of 2.0 mg/mL One-Component Karl Fischer Titrant using a Liquid Water Standard. The results are expressed in **mg/mL**.

Electrode:

- HI 76320 Double Platinum Pin Electrode

Reagents:

- 2 mg/mL One-Component KF Volumetric Titrant
- 1.00 mg/g Liquid Water Standard
- Dry Methanol

Other Accessories:

- A clean, dry 3-mL syringe
- A clean, dry 22-gauge, 6" non-coring septum penetration needle
- GL 45-Thread Solvent Bottle

Procedure:

- Setup titrator according to the instruction manual.
- Press "*Select Method*" from the main screen. Use the arrow keys to highlight 'HI8002EN Stdz 2mg/mL w/ water Std.' and press "*Select*".
- Install a 5-mL burette filled with 2 mg/mL KF Titrant to be standardized and verify that no air bubbles are present in the burette or tubing. If necessary prime until all air has been removed completely.
- Connect the solvent bottle top assembly to the bottle of methanol according to the manual.
- Prepare the titration vessel according to the manual. Dispense enough solvent from the solvent bottle to fill the vessel to the "min" line (about 50 mL).
- Press "Start/Stop" to pre-titrate the solvent and the titration vessel moisture. Allow the background drift rate to stabilize before proceeding to the next step.
- Fill the syringe and needle with the water standard.
- Weigh the syringe, needle and water standard.
- Press "*Start Analysis*". You will be prompted to enter the sample size.
- Dispense 2.00 g (about 2 mL) of standard into the titration vessel through the septum using the needle. Pay attention not to get any sample on the electrode or beaker walls. If necessary swirl the titration vessel by hand.
- Clear the needle of residual standard by intaking a small volume of air from the titration vessel. If a "hanging drop" of standard is seen on the end of the needle, dip the end of the needle briefly in the solvent.
- Remove the needle from the titration vessel and weigh the syringe again in order to determine the

added standard mass (by difference of the two measurements.)

- Use the numeric keypad to enter the exact weight and press "*Enter*" to start the analysis.
- At the end of the titration the "Standardization Result" screen is displayed. The results are expressed in **mg/mL**.

Method Parameters:

Name:	Stdz 2mg/mL w/ water Std
Method Revision:	1.0
Type:	Titrant Standardization
Predispensing Amount:	25 %
Pre-Analysis Stir Time:	5 Sec
Stirring Speed:	900 RPM
Stirbar Type:	Medium
Drift Entry:	Automatic
Solvent:	Methanol
Standard:	Liquid 1.0 mg/g
Type:	Liquid by mass
Concentration Unit:	mg/g
Water Content:	1.0000 mg/g
Standard Size:	2.0000 g
Titrant:	Composite 2
Titrant Type:	One Component
Nominal Titrant Conc.:	2.0000 mg/mL
Std. Titrant Conc.:	2.0000 mg/mL
Date/Time:	Jan 1, 2011 12:00
Titrant Age Reminder:	2d:00h:00m
Control Parameters:	
Start Mode:	Normal
Standby Mode:	Enabled
Standby Duration:	720 minutes
Imposed Current:	20 uA
Minimum Dose:	1.000 uL
Maximum Dose:	20.000 uL
Timed Increment:	1 second
End Point Value:	180.0 mV
Signal Averaging:	3 Readings
Flow Rate:	10.0 mL/min
Termination Parameters:	
Maximum Duration:	1200 sec
Maximum Titrant Volume:	10.0000 mL
Term. Criterion:	Relative Drift
Relative Drift:	7.0 ug/min

Calculations:

Titrant units:	mg/mL
Titrant volume consumed:	V (mL)
Final Results Units:	mg/mL
Standard Concentration:	1.0000 mg/g
Standard mass:	2.0000 g

$$\text{mg/mL} = \frac{1.0000 \times 2.0000}{V}$$

2.0 mg/mL Titrant Standardization using a Liquid Water Standard for one-component titrant

Results:

Titration Report

Method Name: Stdz 2mg/mL w/ water Std.
Time & Date: 12:00 Jan 1, 2011
Standard Size: 2.0000 g
Standard Conc.: 1.0000 mg/g
Drift Value: 5.0 ug/min
End Point Volume: 1.0605 mL
Result: 1.9103 mg/mL
Titration Duration: 5:10 [mm:ss]
Estimated Cell Volume: 60.11 mL
Titration went to Completion
Operator Name:
Analyst Signature: _____

1.0 mg/mL Titrant Standardization using a Liquid Water Standard

for one-component titrant

Description:

Method for the standardization of 1.0 mg/mL One-Component Karl Fischer Titrant using a Liquid Water Standard. The results are expressed in **mg/mL**.

Electrode:

- HI 76320 Double Platinum Pin Electrode

Reagents:

- 1 mg/mL One-Component KF Volumetric Titrant
- 1 mg/g Liquid Water Standard
- Dry Methanol

Other Accessories:

- A clean, dry 3-mL syringe
- A clean, dry 22-gauge, 6" non-coring septum penetration needle
- GL 45-Thread Solvent Bottle

Procedure:

- Setup titrator according to the instruction manual.
- Press "*Select Method*" from the main screen. Use the arrow keys to highlight 'HI8003EN Stdz 1mg/mL w/ water Std.' and press "*Select*".
- Install a 5-mL burette filled with 1 mg/mL KF Titrant to be standardized and verify that no air bubbles are present in the burette or tubing. If necessary prime until all air has been removed completely.
- Connect the solvent bottle top assembly to the bottle of methanol (or solvent) according to the manual.
- Prepare the titration vessel according to the manual. Dispense enough solvent from the solvent bottle to fill the vessel to the "min" line (about 50 mL).
- Press "Start/Stop" to pre-titrate the solvent and the titration vessel moisture. Allow the background drift rate to stabilize before proceeding to the next step.
- Fill the syringe and needle with the water standard.
- Weigh the syringe, needle and water standard.
- Press "*Start Analysis*". You will be prompted to enter the sample size.
- Dispense 2.00 g (about 2 mL) of standard into the titration vessel through the septum using the needle. Pay attention not to get any sample on the electrode or beaker walls. If necessary swirl the titration vessel by hand.
- Clear the needle of residual standard by intaking a small volume of air from the titration vessel. If a "hanging drop" of standard is seen on the end of the needle, dip the end of the needle briefly in the solvent.
- Remove the needle from the titration vessel and weigh the syringe again in order to determine the

added standard mass (by difference of the two measurements.)

- Use the numeric keypad to enter the exact weight and press "*Enter*" to start the analysis.
- At the end of the titration the "Standardization Result" screen is displayed. The results are expressed in **mg/mL**.

Method Parameters:

Name:	Stdz 1mg/mL w/ water Std
Method Revision:	1.0
Type:	Titrant Standardization
Predispensing Amount:	25 %
Pre-Analysis Stir Time:	5 Sec
Stirring Speed:	900 RPM
Stirbar Type:	Medium
Drift Entry:	Automatic
Solvent:	Methanol
Standard:	Liquid 1.0 mg/g
Type:	Liquid by mass
Concentration Unit:	mg/g
Water Content:	1.0000 mg/g
Standard Size:	2.0000 g
Titrant:	Composite 1
Titrant Type:	One Component
Nominal Titrant Conc.:	1.0000 mg/mL
Std. Titrant Conc.:	1.0000 mg/mL
Date/Time:	Jan 1, 2011 12:00
Titrant Age Reminder:	2d:00h:00m
Control Parameters:	
Start Mode:	Normal
Standby Mode:	Enabled
Standby Duration:	720 minutes
Imposed Current:	20 uA
Minimum Dose:	2.000 uL
Maximum Dose:	40.000 uL
Timed Increment:	1 second
End Point Value:	180.0 mV
Signal Averaging:	3 Readings
Flow Rate:	10.0 mL/min
Termination Parameters:	
Maximum Duration:	1200 sec
Maximum Titrant Volume:	10.0000 mL
Term. Criterion:	Relative Drift
Relative Drift:	7.0 ug/min

Calculations:

Titrant units:	mg/mL
Titrant volume consumed:	V (mL)
Final Results Units:	mg/g
Standard Concentration:	1.0000 mg/g
Standard mass:	2.0000 g

$$\text{mg/mL} = \frac{1.0000 \times 2.0000}{V}$$

1.0 mg/mL Titrant Standardization using a Liquid Water Standard for one-component titrant

Results:

Titration Report

Method Name: Stdz 1mg/mL w/ water Std.
Time & Date: 12:00 Jan 1, 2011
Standard Size: 2.0000 g
Standard Conc.: 1.0000 mg/g
Drift Value: 5.0 ug/min
End Point Volume: 1.8732 mL
Result: 1.0824 mg/mL
Titration Duration: 5:30 [mm:ss]
Estimated Cell Volume: 64.20 mL
Titration went to Completion
Operator Name:
Analyst Signature: _____

5.0 mg/mL Titrant Standardization using Disodium Tartrate Dihydrate

for one-component titrant

Description:

Method for the standardization of 5.0 mg/mL One-Component Karl Fischer Titrant using Disodium Tartrate Dihydrate water standard. The results are expressed in **mg/mL**.

Electrode:

- HI 76320 Double Platinum Pin Electrode

Reagents:

- 5 mg/mL One-Component KF Volumetric Titrant
- Disodium Tartrate Dihydrate, 15.66% H₂O (w/w)
- Dry Methanol
- Dry Formamide

Other Accessories:

- A clean, dry weigh boat
- GL 45-Thread Solvent Bottle

Procedure:

- Setup titrator according to the instruction manual.
- Press "*Select Method*" from the main screen. Use the arrow keys to highlight 'HI8011EN Stdz 5mg/mL w/ Tartrate' and press "*Select*".
- Install a 5-mL burette filled with 5 mg/mL One-Component KF Titrant to be standardized and verify that no air bubbles are present in the burette or tubing. If necessary prime until all air has been removed completely.
- Connect the solvent bottle top assembly to the bottle of methanol according to the manual.
- Prepare at least 200 mL of solvent by mixing 2 parts dry methanol and 2 parts dry formamide in a solvent bottle.
- Attach the solvent bottle top assembly to the bottle according to the instruction manual.
- Prepare the titration vessel according to the manual. Dispense enough solvent from the solvent bottle to fill the vessel to the "min" line (about 50 mL).
- Press "Start/Stop" to pre-titrate the solvent and the titration vessel moisture. Allow the background drift rate to stabilize before proceeding to the next step.
- Add 0.050 g to 0.100 g of tartrate standard to a weigh boat.
- Weigh the weigh boat and tartrate standard.
- Press "*Start Analysis*". You will be prompted to enter the sample size.
- Quickly remove the sample port plug from the beaker assembly, pour the tartrate into the titration vessel, and replace the sample port plug. Pay attention not to get any sample on the electrode or beaker walls. If necessary swirl the titration vessel by hand.

- Weigh the weigh boat again in order to determine the added standard mass (by difference of the two measurements.)
- Use the numeric keypad to enter the exact weight and press "*Enter*" to start the analysis.
- At the end of the titration the "Standardization Result" screen is displayed. The results are expressed in **mg/mL**.

Method Parameters:

Name:	Stdz 5mg/mL w/ Tartrate
Method Revision:	1.0
Type:	Titrant Standardization
Predispensing Amount:	15 %
Pre-Analysis Stir Time:	30 Sec
Stirring Speed:	900 RPM
Stirbar Type:	Medium
Drift Entry:	Automatic
Solvent:	MeOH Form. 2:1
Standard:	Sodium Tartrate
Type:	Solid by mass
Concentration Unit:	%
Water Content:	15.66 %
Standard Size:	0.1000 g
Titrant:	Composite 5
Titrant Type:	One Component
Nominal Titrant Conc.:	5.0000 mg/mL
Std. Titrant Conc.:	5.0000 mg/mL
Date/Time:	Jan 1, 2011 12:00
Titrant Age Reminder:	2d:00h:00m
Control Parameters:	
Start Mode:	Normal
Standby Mode:	Enabled
Standby Duration:	720 minutes
Imposed Current:	20 uA
Minimum Dose:	2.000 uL
Maximum Dose:	40.000 uL
Timed Increment:	1 second
End Point Value:	180.0 mV
Signal Averaging:	3 Readings
Flow Rate:	10.0 mL/min
Termination Parameters:	
Maximum Duration:	1200 sec
Maximum Titrant Volume:	10.0000 mL
Term. Criterion:	Relative Drift
Relative Drift:	7.0 ug/min

Calculations:

Titrant units:	mg/mL
Titrant volume consumed:	V (mL)
Final Results Units:	mg/mL
Standard Concentration:	15.66 %
Standard mass:	0.1000 g

$$\text{mg/mL} = \frac{0.1000 \times 0.1566 \times 1000}{V}$$

5.0 mg/mL Titrant Standardization using Disodium Tartrate Dihydrate for one-component titrant

Results:

Titration Report

Method Name: Stdz 5mg/mL w/ Tartrate
Time & Date: 12:00 Jan 1, 2011
Standard Size: 0.1000 g
Standard Conc.: 15.66 %
Drift Value: 4.0 ug/min
End Point Volume: 3.1185 mL
Result: 5.0329 mg/mL
Titration Duration: 8:48 [mm:ss]
Estimated Cell Volume: 69.26 mL
Titration went to Completion
Operator Name:
Analyst Signature: _____

Moisture Determination in Dairy Cream

Description:

Method for the determination of moisture in Dairy Cream. The results are expressed in % mass and should be between 70 and 80 %.

Electrode:

- HI 76320 Double Platinum Pin Electrode

Reagents:

- 5 mg/mL One-Component KF Volumetric Titrant
- Dry Methanol
- Dry Chloroform
- Dry Formamide

Other Accessories:

- A clean, dry 1-mL syringe
- A clean, dry 22-gauge, 6" non-coring septum penetration needle
- GL 45-Thread Solvent Bottle

Procedure:

- Setup titrator according to the instruction manual.
- Press "*Select Method*" from the main screen. Use the arrow keys to highlight 'HI8101EN Moisture in Dairy Cream' and press "*Select*".
- Install a 5-mL burette filled with 5 mg/mL One-Component KF Volumetric Titrant and verify that no air bubbles are present in the burette or tubing. If necessary prime until all air has been removed completely.

For the determination of the exact concentration of the titrant, follow **HI8001EN 5.0 mg/mL Titrant Standardization using Liquid Water Standard**.

- Prepare at least 200 mL of solvent by adding 2 parts dry chloroform, 2 parts dry methanol, and 1 part dry formamide in a solvent bottle. Attach the solvent bottle top assembly to the bottle according to the instruction manual.
- Prepare the titration vessel according to the manual. Dispense enough solvent from the solvent bottle to fill the vessel to the "min" line (about 50 mL).
- Press "Start/Stop" to pre-titrate the solvent and the titration vessel moisture. Allow the background drift rate to stabilize before proceeding to the next step.
- Fill the syringe and needle with the sample.
- Weigh the syringe, needle and cream.
- Press "*Start Analysis*". You will be prompted to enter the sample size.
- Dispense 0.0200 g to 0.0250 g of dairy cream into the titration vessel through the septum using the needle. Pay attention not to get any sample on the electrode or beaker walls. If necessary swirl the titration vessel by hand.
- Clear the needle of residual sample by intaking a small volume of air from the titration vessel. If a "hanging drop" of sample is seen on the end of the

needle, dip the end of the needle briefly in the solvent.

- Remove the needle from the titration vessel and weigh the syringe again in order to determine the added sample mass (by difference of the two measurements.)
- Use the numeric keypad to enter the exact weight and press "*Enter*" to start the analysis.
- At the end of the titration the "Sample Analysis Result" screen is displayed. The results are expressed in % **mass** of water.

Method Parameters:

Name:	Moisture in Dairy Cream
Method Revision:	1.0
Type:	Sample Analysis
Predispensing Amount:	30 %
Pre-Analysis Stir Time:	30 Sec
Stirring Speed:	900 RPM
Stirbar Type:	Medium
Drift Entry:	Automatic
Solvent:	Cream Solvent
Sample Parameters:	
Sample Determ.:	Normal
Sample Name:	Dairy Cream
Sample Type:	Mass
Sample Size:	0.0250 g
Titrant:	Composite 5
Titrant Type:	One Component
Nominal Titrant Conc.:	5.0000 mg/mL
Std. Titrant Conc.:	5.0000 mg/mL
Date/Time:	Jan 01, 2011 12:00
Titrant Age Reminder:	2d:00h:00m
Control Parameters:	
Start Mode:	Normal
Standby Mode:	Enabled
Standby Duration:	720 minutes
Imposed Current:	20 uA
Minimum Dose:	0.500 uL
Maximum Dose:	30.000 uL
Timed Increment:	1 second
End Point Value:	180.0 mV
Signal Averaging:	3 Readings
Flow Rate:	10.0 mL/min
Termination Parameters:	
Maximum Duration:	900 sec
Maximum Titrant Volume:	10.0000 mL
Term. Criterion:	Relative Drift
Relative Drift:	15.0 ug/min
Result Unit:	%

Calculations:

Titrant units:	mg/mL
Titrant volume consumed:	V (mL)
Final results units:	% Mass
Titrant concentration:	5.0000 mg/mL
Sample mass:	0.0250 g

$$\% \text{ Mass} = \frac{V \times 5.0000}{0.0250 \times 10}$$

Moisture Determination in Dairy Cream

Results:

Titration Report

Method Name: Moisture in Dairy Cream
Time & Date: 12:00 Jan 01, 2011
Sample Size: 0.0241 g
Std. Titrant Conc.: 5.0000 mg/mL
Drift Value: 4.7 ug/min
End Point Volume: 3.4567 mL
Result: 71.5481 %
Titration Duration: 8:36 [mm:ss]
Estimated Cell Volume: 65.72 mL
Titration went to Completion
Operator Name:
Analyst Signature: _____

Moisture Determination in Milk

Description:

Method for the determination of moisture in Milk. The results are expressed in % mass and should be between 80 and 95 %.

Electrode:

- HI 76320 Double Platinum Pin Electrode

Reagents:

- 5 mg/mL One-Component KF Volumetric Titrant
- Dry Methanol

Other Accessories:

- A clean, dry 1-mL syringe
- A clean, dry 22-gauge, 6" non-coring septum penetration needle
- GL 45-Thread Solvent Bottle

Procedure:

- Setup titrator according to the instruction manual.
- Press "*Select Method*" from the main screen. Use the arrow keys to highlight 'HI8102EN Moisture in Milk' and press "*Select*".
- Install a 5-mL burette filled with 5 mg/mL One-Component KF Volumetric Titrant and verify that no air bubbles are present in the burette or tubing. If necessary prime until all air has been removed completely.

For the determination of the exact concentration of the titrant follow **HI8001EN 5.0 mg/mL Titrant Standardization using Liquid Water Standard**.

- Connect the solvent bottle top assembly to the bottle of methanol according to the manual.
- Prepare the titration vessel according to the manual. Dispense enough solvent from the solvent bottle to fill the vessel to the "min" line (about 50 mL).
- Press "Start/Stop" to pre-titrate the solvent and the titration vessel moisture. Allow the background drift rate to stabilize before proceeding to the next step.
- Fill the syringe and needle with the sample.
- Weigh the syringe, needle and milk.
- Press "*Start Analysis*". You will be prompted to enter the sample size.
- Dispense 0.0150 g to 0.0200 g of milk into the titration vessel through the septum using the needle. Pay attention not to get any sample on the electrode or beaker walls. If necessary swirl the titration vessel by hand.
- Clear the needle of residual sample by intaking a small volume of air from the titration vessel. If a "hanging drop" of sample is seen on the end of the needle, dip the end of the needle briefly in the solvent.
- Remove the needle from the titration vessel and weigh the syringe again in order to determine the

added sample mass (by difference of the two measurements.)

- Use the numeric keypad to enter the exact weight and press "*Enter*" to start the analysis.
- At the end of the titration the "Sample Analysis Result" screen is displayed. The results are expressed in % **mass** of water.

Method Parameters:

Name:	Moisture in Milk
Method Revision:	1.0
Type:	Sample Analysis
Predispensing Amount:	30 %
Pre-Analysis Stir Time:	15 Sec
Stirring Speed:	900 RPM
Stirbar Type:	Medium
Drift Entry:	Automatic
Solvent:	Methanol
Sample Parameters:	
Sample Determ.:	Normal
Sample Name:	Milk
Sample Type:	Mass
Sample Size:	0.0200 g
Titrant:	Composite 5
Titrant Type:	One Component
Nominal Titrant Conc.:	5.0000 mg/mL
Std. Titrant Conc.:	5.0000 mg/mL
Date/Time:	Jan 1, 2011 12:00
Titrant Age Reminder:	2d:00h:00m
Control Parameters:	
Start Mode:	Normal
Standby Mode:	Enabled
Standby Duration:	720 minutes
Imposed Current:	20 uA
Minimum Dose:	0.5000 uL
Maximum Dose:	40.0000 uL
Timed Increment:	1 second
End Point Value:	180.0 mV
Signal Averaging:	3 Readings
Flow Rate:	10.0 mL/min
Termination Parameters:	
Maximum Duration:	900 sec
Maximum Titrant Volume:	10.0000 mL
Term. Criterion:	Relative Drift
Relative Drift:	15.0 ug/min
Result Unit:	%

Calculations:

Titrant units:	mg/mL
Titrant volume consumed:	V (mL)
Final results units:	% Mass
Titrant concentration:	5.0000 mg/mL
Sample mass:	0.0200 g

$$\% \text{ Mass} = \frac{V \times 5.0000}{0.0200 \times 10}$$

Moisture Determination in Milk

Results:

Titration Report

Method Name: Moisture in Milk
Time & Date: 12:00 Jan 01, 2011
Sample Size: 0.0188 g
Std. Titrant Conc.: 5.0000 mg/mL
Drift Value: 4.5 ug/min
End Point Volume: 3.2614 mL
Result: 86.5886 %
Titration Duration: 6:18 [mm:ss]
Estimated Cell Volume: 60.03 mL
Titration went to Completion
Operator Name:
Analyst Signature: _____

Moisture Determination in Honey

Description:

Method for the determination of moisture in Honey. The results are expressed in % mass and should be between 15 and 20 %.

Electrode:

- HI 76320 Double Platinum Pin Electrode

Reagents:

- 5 mg/mL One-Component KF Volumetric Titrant
- Dry Methanol

Other Accessories:

- A clean, dry 1-mL syringe (no needle)
- GL 45-Thread Solvent Bottle

Procedure:

- Setup titrator according to the instruction manual.
- Press "*Select Method*" from the main screen. Use the arrow keys to highlight 'HI8103EN Moisture in Honey' and press "*Select*".
- Install a 5-mL burette filled with 5 mg/mL One-Component KF Volumetric Titrant and verify that no air bubbles are present in the burette or tubing. If necessary prime until all air has been removed completely.

For the determination of the exact concentration of the titrant follow **HI8001EN 5.0 mg/mL Titrant Standardization using Liquid Water Standard**.

- Connect the solvent bottle top assembly to the bottle of methanol according to the manual.
- Prepare the titration vessel according to the manual. Dispense enough solvent from the solvent bottle to fill the vessel to the "min" line (about 50 mL).
- Press "Start/Stop" to pre-titrate the solvent and the titration vessel moisture. Allow the background drift rate to stabilize before proceeding to the next step.
- Fill the syringe with the sample.
- Weigh the syringe and honey.
- Press "*Start Analysis*". You will be prompted to enter the sample size.
- Remove the sample port plug and dispense 0.0500 g to 0.1000 g of honey (about 2-3 small drops) into the titration vessel through the sample port. Replace the sample port plug as quickly as possible to prevent humidity from entering the titration beaker. Pay attention not to get any sample on the electrode or beaker walls. If necessary swirl the titration vessel by hand.
- Weigh the syringe again in order to determine the added sample mass (by difference of the two measurements.)
- Use the numeric keypad to enter the exact weight and press "*Enter*" to start the analysis.

- At the end of the titration the "Sample Analysis Result" screen is displayed. The results are expressed in % mass of water.

Method Parameters:

Name: Moisture in Honey
 Method Revision: 1.0
 Type: Sample Analysis
 Predispensing Amount: None
 Pre-Analysis Stir Time: 60 Sec
 Stirring Speed: 900 RPM
 Stirbar Type: Medium
 Drift Entry: Automatic
 Solvent: Methanol

Sample Parameters:
 Sample Determ.: Normal
 Sample Name: Honey
 Sample Type: Mass
 Sample Size: 0.1000 g
 Titrant:
 Titrant Type: One Component
 Nominal Titrant Conc.: 5.0000 mg/mL
 Std. Titrant Conc.: 5.0000 mg/mL
 Date/Time: Jan 1, 2011 12:00
 Titrant Age Reminder: 2d:00h:00m

Control Parameters:
 Start Mode: Normal
 Standby Mode: Enabled
 Standby Duration: 720 minutes
 Imposed Current: 20 uA
 Minimum Dose: 0.5000 uL
 Maximum Dose: 20.0000 uL
 Timed Increment: 1 second
 End Point Value: 180.0 mV
 Signal Averaging: 3 Readings
 Flow Rate: 10.0 mL/min

Termination Parameters:
 Maximum Duration: 900 sec
 Maximum Titrant Volume: 10.0000 mL
 Term. Criterion: Relative Drift
 Relative Drift: 10.0 ug/min

Result Unit: %

Calculations:

Titrant units: mg/mL
 Titrant volume consumed: V (mL)
 Final results units: % Mass
 Titrant concentration: 5.0000 mg/mL
 Sample mass: 0.1000 g

$$\% \text{ Mass} = \frac{V \times 5.0000}{0.1000 \times 10}$$

Results:

Titration Report

Method Name: Moisture in Honey
 Time & Date: 12:00 Jan 1, 2011
 Sample Size: 0.0916 g
 Std. Titrant Conc.: 5.0000 mg/mL
 Drift Value: 3.8 ug/min
 End Point Volume: 3.4523 mL
 Result: 17.2345 %
 Titration Duration: 7:06 [mm:ss]
 Estimated Cell Volume: 57.16 mL
 Titration went to Completion
 Operator Name:
 Analyst Signature: _____

Surface Moisture Determination on White Sugar

Description:

Method for the determination of the surface moisture content of white sugar. The results are expressed in **ppm** and should be between 250 and 350 ppm.

Electrode:

- HI 76320 Double Platinum Pin Electrode

Reagents:

- 1 mg/mL One-Component KF Volumetric Titrant
- Dry Methanol
- Dry Chloroform

Other Accessories:

- A clean, dry weigh boat
- GL 45-Thread Solvent Bottle

Procedure:

- Setup titrator according to the instruction manual.
- Press "*Select Method*" from the main screen. Use the arrow keys to highlight 'HI8104EN Surface Moisture - Sugar' and press "*Select*".
- Install a 5-mL burette filled with 1 mg/mL One-Component KF Volumetric Titrant and verify that no air bubbles are present in the burette or tubing. If necessary prime until all air has been removed completely.
For the determination of the exact concentration of the titrant follow **HI8003EN 1.0 mg/mL Titrant Standardization using Liquid Water Standard**.
- Prepare at least 200 mL of solvent by adding 2 parts dry chloroform to 1 part dry methanol in a solvent bottle. Attach the solvent bottle top assembly to the bottle according to the instruction manual.
- Prepare the titration vessel according to the manual. Dispense enough solvent from the solvent bottle to fill the vessel to the "min" line (about 50 mL).
- Press "Start/Stop" to pre-titrate the solvent and the titration vessel moisture. Allow the background drift rate to stabilize before proceeding to the next step.
- Fill the weigh boat with 7.5 to 10 g of sample.
- Weigh the weigh boat and sample.
- Press "*Start Analysis*". You will be prompted to enter the sample size.
- Remove the sample port and use the weight boat to transfer the solid sample into the titration vessel. Replace the sample port plug as quickly as possible to prevent humidity from entering the titration beaker. Pay attention not to get any sample on the electrode or beaker walls. If necessary swirl the titration vessel by hand.
- Weigh the weigh boat again in order to determine the added sample mass (by difference of the two measurements.)

- Use the numeric keypad to enter the exact weight and press "*Enter*" to start the analysis.
- At the end of the titration the "Sample Analysis Result" screen is displayed. The results are expressed in **ppm** of water.
- Use fresh solvent after every 2 to 3 titrations.

Method Parameters:

Name:	Surface Moisture - Sugar
Method Revision:	1.0
Type:	Sample Analysis
Predispensing Amount:	None
Pre-Analysis Stir Time:	120 Sec
Stirring Speed:	900 RPM
Stirbar Type:	Medium
Drift Entry:	Automatic
Solvent:	CHCl3 MeOH 2:1
Sample Parameters:	
Sample Determ.:	Normal
Sample Name:	Sugar
Sample Type:	Mass
Sample Size:	7.5000 g
Titrant:	
Titrant Type:	One Component
Nominal Titrant Conc.:	1.0000 mg/mL
Std. Titrant Conc.:	1.0000 mg/mL
Date/Time:	Jan 1, 2011 12:00
Titrant Age Reminder:	2d:00h:00m
Control Parameters:	
Start Mode:	Normal
Standby Mode:	Enabled
Standby Duration:	720 minutes
Imposed Current:	20 uA
Minimum Dose:	1.000 uL
Maximum Dose:	30.000 uL
Timed Increment:	1 second
End Point Value:	180.0 mV
Signal Averaging:	3 Readings
Flow Rate:	10.0 mL/min
Termination Parameters:	
Maximum Duration:	900 sec
Maximum Titrant Volume:	10.0000 mL
Term. Criterion:	Relative Drift
Relative Drift:	20.0 ug/min
Result Unit:	ppm

Calculations:

Calculations:	
Titrant units:	mg/mL
Titrant volume consumed:	V (mL)
Final results units:	ppm
Titrant concentration:	1.0000 mg/mL
Sample mass:	7.5000 g

$$\text{ppm} = \frac{V \times 1.0000 \times 1000}{7.5000}$$

Surface Moisture Determination on White Sugar

Results:

Titration Report

Method Name: Surface Moisture - Sugar
Time & Date: 12:00 Jan 1, 2011
Sample Size: 7.5231 g
Std. Titrant Conc.: 1.0000 mg/mL
Drift Value: 5.7 ug/min
End Point Volume: 2.4292 mL
Result: 319 ppm
Titration Duration: 4:42 [mm:ss]
Estimated Cell Volume: 62.4 mL
Titration went to Completion
Operator Name:
Analyst Signature: _____

Moisture Determination in Cooking Oil

Description:

Method for the determination of moisture in cooking oil. The results are expressed in ppm and should be between 200 and 800 ppm.

Electrode:

- HI 76320 Double Platinum Pin Electrode

Reagents:

- 1 mg/mL One-Component KF Volumetric Titrant
- Dry Methanol
- Dry Chloroform

Other Accessories:

- A clean, dry 25-mL syringe
- A clean, dry 18-gauge, 6" non-coring septum penetration needle
- GL 45-Thread Solvent Bottle

Procedure:

- Setup titrator according to the instruction manual.
- Press "*Select Method*" from the main screen. Use the arrow keys to highlight 'HI8105EN Moisture in Cooking Oil' and press "*Select*".
- Install a 5-mL burette filled with 1 mg/mL One-Component KF Volumetric Titrant and verify that no air bubbles are present in the burette or tubing. If necessary prime until all air has been removed completely.
For the determination of the exact concentration of the titrant follow **HI8003EN 1.0 mg/mL Titrant Standardization using Liquid Water Standard**.
- Prepare at least 200 mL of solvent by adding 1 part dry chloroform to 1 part dry methanol in a solvent bottle. Attach the solvent bottle top assembly to the bottle according to the instruction manual.
- Prepare the titration vessel according to the manual. Dispense enough solvent from the solvent bottle to fill the vessel to the "min" line (about 50 mL).
- Press "Start/Stop" to pre-titrate the solvent and the titration vessel moisture. Allow the background drift rate to stabilize before proceeding to the next step.
- Fill the syringe and needle with sample.
- Weigh the syringe, needle and oil.
- Press "*Start Analysis*". You will be prompted to enter the sample size.
- Dispense 3 g to 5 g of cooking oil into the titration vessel through the septum using the needle. Pay attention not to get any sample on the electrode or beaker walls. If necessary swirl the titration vessel by hand.
- Clear the needle of residual sample by intaking a small volume of air from the titration vessel. If a "hanging drop" of sample is seen on the end of the

needle, dip the end of the needle briefly in the solvent.

- Remove the needle from the titration vessel and weigh the syringe again in order to determine the added sample mass (by difference of the two measurements.)
- Use the numeric keypad to enter the exact weight and press "*Enter*" to start the analysis.
- At the end of the titration the "Sample Analysis Result" screen is displayed. The results are expressed in **ppm** of water.
- Change the solvent after every 3 to 4 titration or if phase-separation occurs.

Method Parameters:

Name:	Moisture in Cooking Oil
Method Revision:	1.0
Type:	Sample Analysis
Predispensing Amount:	None
Pre-Analysis Stir Time:	15 Sec
Stirring Speed:	900 RPM
Stirbar Type:	Medium
Drift Entry:	Automatic
Solvent:	CHCl3 MeOH 1:1
Sample Parameters:	
Sample Determ.:	Normal
Sample Name:	Oil
Sample Type:	Mass
Sample Size:	4.0000 g
Titrant:	Composite 1
Titrant Type:	One Component
Nominal Titrant Conc.:	1.0000 mg/mL
Std. Titrant Conc.:	1.0000 mg/mL
Date/Time:	Jan 1, 2010 12:01
Titrant Age Reminder:	2d:00h:00m
Control Parameters:	
Start Mode:	Cautious
Standby Mode:	Enabled
Standby Duration:	720 minutes
Imposed Current:	20 uA
Minimum Dose:	1.000 uL
Maximum Dose:	30.000 uL
Timed Increment:	1 second
End Point Value:	180.0 mV
Signal Averaging:	3 Readings
Flow Rate:	10.0 mL/min
Termination Parameters:	
Maximum Duration:	900 sec
Maximum Titrant Volume:	10.0000 mL
Term. Criterion:	Relative Drift
Relative Drift:	10.0 ug/min
Result Unit:	ppm

Calculations:

Calculations:	
Titrant units:	mg/mL
Titrant volume consumed:	V (mL)
Final results units:	ppm
Titrant concentration:	1.0000 mg/mL
Sample mass:	4.0000 g

$$\text{ppm} = \frac{V \times 1.0000 \times 1000}{4.0000}$$

Moisture Determination in Cooking Oil

Results:

Titration Report

Method Name: Moisture in Cooking Oil
Time & Date: 12:00 Jan 1, 2011
Sample Size: 4.0296 g
Std. Titrant Conc.: 1.0000 mg/mL
Drift Value: 3.4 ug/min
End Point Volume: 2.6808 mL
Result: 660 ppm
Titration Duration: 6:30 [mm:ss]
Estimated Cell Volume: 58.11 mL
Titration went to Completion
Operator Name:
Analyst Signature: _____

Moisture Determination in Butter

by external dissolution

Description:

Method for the determination of moisture in Butter by external dissolution. The results are expressed in % mass and should be between 15 and 20 %.

Electrode:

- HI 76320 Double Platinum Pin Electrode

Reagents:

- 5 mg/mL One-Component KF Volumetric Titrant
- Solvent for KF Volumetric Titration
- Dry Methanol
- Dry Chloroform

Other Accessories:

- A clean, dry 1-mL syringe
- A clean, dry 22-gauge, 6" non-coring septum penetration needle
- GL 45-Thread Solvent Bottle
- 100-mL dissolution bottle with septum
- Magnetic stirrer and stirbar

External Dissolution Procedure:

- To an external dissolution bottle with septum, add a magnetic stir bar. Weigh the bottle and record this value.
 - Add 15 g of dry methanol and 25 g of dry chloroform to the bottle and stir for 15 to 20 minutes.
 - Determine the moisture content of the solvent mix. For the determination of the exact concentration of the solvent mix, follow **HI8301EN Solvent w/ 5mg/mL 1-comp.**
 - Enter the solvent moisture concentration by pressing *Method Options*, then *Sample Parameters*, then *External Solvent Concentration*. Use the numeric keypad to enter the exact concentration. Press *Accept* or *Enter*.
 - Weigh the dissolution bottle to determine the weight of the remaining solvent (by subtracting the empty bottle mass). Enter the exact mass by re-entering *Sample Parameters* and selecting *External Solvent Size*. Use the numeric keypad to enter the exact mass. Press *Accept* or *Enter*.
 - Add 2.0 to 4.0 g of butter to the bottle. Weigh the bottle to determine the exact dissolved sample weight. Enter the exact mass by re-entering *Sample Parameters* and selecting *Dissolved Sample Size*. Use the numeric keypad to enter the exact mass. Press *Accept* or *Enter*.
 - To dissolve the butter, mix for 20 to 30 minutes. The resulting solution will be used to determine the water content.
- Note:** Titrate the solution immediately.

Titration Procedure:

- Setup titrator according to the instruction manual.
- Press "*Select Method*" from the main screen. Use the arrow keys to highlight 'HI8106EN Moisture in Butter' and press "*Select*".
- Install a 5-mL burette filled with 5 mg/mL One-Component KF Volumetric Titrant and verify that no air bubbles are present in the burette or tubing. If necessary prime until all air has been removed completely.
For the determination of the exact concentration of the titrant follow **HI8001EN 5.0 mg/mL Titrant Standardization using Liquid Water Standard.**
- Connect the solvent bottle top assembly to the bottle of methanol according to the manual.
- Prepare the titration vessel according to the manual. Dispense enough solvent from the solvent bottle to fill the vessel to the "min" line (about 50 mL).
- Press "Start/Stop" to pre-titrate the titration solvent and the titration vessel moisture. Allow the background drift rate to stabilize before proceeding to the next step.
- Fill the syringe and needle with the sample solution.
- Weigh the syringe, needle and sample solution.
- Press "*Start Analysis*". You will be prompted to enter the sample size.
- Dispense 0.5000 g to 1.0000 g of sample solution into the titration vessel through the septum using the needle. Pay attention not to get any sample on the electrode or beaker walls. If necessary swirl the titration vessel by hand.
- Clear the needle of residual sample by intaking a small volume of air from the titration vessel. If a "hanging drop" of sample is seen on the end of the needle, dip the end of the needle briefly in the solvent.
- Remove the needle from the titration vessel and weigh the syringe again in order to determine the added sample mass (by difference of the two measurements.)
- Use the numeric keypad to enter the exact weight and press "*Enter*" to start the analysis.
- At the end of the titration the "Sample Analysis Result" screen is displayed. The results are expressed in % **mass** of water.
- The use of external dissolution increases the precision and drastically lowers the load of the solvent, allowing you to run more titrations without changing the solvent. Use fresh titration solvent after every 10 - 12 titrations.

Moisture Determination in Butter

by external dissolution

Method Parameters:

Name: Moisture in Butter
 Method Revision: 1.0
 Type: Sample Analysis
 Predispensing Amount: None
 Pre-Analysis Stir Time: 10 Sec
 Stirring Speed: 900 RPM
 Stirbar Type: Medium
 Drift Entry: Automatic
 Solvent: Methanol
 Sample Parameters:
 Sample Determ.: External Dissolution
 Sample Name: Butter
 Sample Size: 0.7500 g
 External Solvent Size: 40.0000 g
 External Solvent Conc.: 0.0100 %
 Extracted Sample Size: 3.0000 g
 Titrant: Composite 5
 Titrant Type: One Component
 Nominal Titrant Conc.: 5.0000 mg/mL
 Std. Titrant Conc.: 5.0000 mg/mL
 Date/Time: Jan 1, 2011 12:00
 Titrant Age Reminder: 2d:00h:00m
 Control Parameters:
 Start Mode: Normal
 Standby Mode: Enabled
 Standby Duration: 720 minutes
 Imposed Current: 20 uA
 Minimum Dose: 0.5000 uL
 Maximum Dose: 40.0000 uL
 Timed Increment: 1 second
 End Point Value: 180.0 mV
 Signal Averaging: 3 Readings
 Flow Rate: 10.0 mL/min
 Termination Parameters:
 Maximum Duration: 720 sec
 Maximum Titrant Volume: 10.0000 mL
 Term. Criterion: Relative Drift
 Relative Drift: 15.0 ug/min
 Result Unit: %

Results:

Titration Report

Method Name: Moisture in Butter
 Time & Date: 12:00 Jan 01, 2011
 Sample Size: 0.7841 g
 Std. Titrant Conc.: 5.0000 mg/mL
 Drift Value: 4.6 ug/min
 End Point Volume: 2.4497 mL
 External Solvent Size: 38.4979 g
 External Solvent Conc.: 0.0167 %
 External Sample Size: 3.1222 g
 Result: 19.3903 %
 Titration Duration: 6:54 [mm:ss]
 Estimated Cell Volume: 61.0 mL
 Titration went to Completion
 Operator Name:
 Analyst Signature: _____

Calculations:

Titrant units: mg/mL
 Titrant volume consumed: V (mL)
 Final results units: % Mass
 Titrant concentration: 5.0000 mg/mL
 External Solvent Size: 40.0000 g
 External Solvent Conc.: 0.0100 %
 External Sample Size: 3.0000 g
 Sample mass: 0.7500 g

$$\% \text{ Mass} = \frac{40.0000}{3.0000} \times \frac{\left(\frac{5.0000 \times V}{0.7500 \times 10}\right) - 0.0100}{100 - \left(\frac{5.0000 \times V}{0.7500 \times 10}\right)} \times 100$$

Moisture Determination in Margarine

by external dissolution

Description:

Method for the determination of moisture in Margarine by external dissolution. The results are expressed in % mass and should be between 15 and 30 %.

Electrode:

- HI 76320 Double Platinum Pin Electrode

Reagents:

- 5 mg/mL One-Component KF Volumetric Titrant
- Solvent for KF Volumetric Titration
- Dry Methanol
- Dry Chloroform

Other Accessories:

- A clean, dry 1-mL syringe
- A clean, dry 22-gauge, 6" non-coring septum penetration needle
- GL 45-Thread Solvent Bottle
- 100-mL dissolution bottle with septum
- Magnetic stirrer and stirbar

External Dissolution Procedure:

- To an external dissolution bottle with septum, add a magnetic stir bar. Weigh the bottle and record this value.
- Add 20 g of dry methanol and 20 g of dry chloroform to the bottle and stir for 15 to 20 minutes.
- Determine the moisture content of the solvent mix. For the determination of the exact concentration of the solvent mix, follow **HI8301EN Solvent w/ 5mg/mL 1-comp.**
- Enter the solvent moisture concentration by pressing *Method Options*, then *Sample Parameters*, then *External Solvent Concentration*. Use the numeric keypad to enter the exact concentration. Press *Accept* or *Enter*.
- Weigh the dissolution bottle to determine the weight of the remaining solvent (by subtracting the empty bottle mass). Enter the exact mass by re-entering *Sample Parameters* and selecting *External Solvent Size*. Use the numeric keypad to enter the exact mass. Press *Accept* or *Enter*.
- Add 2.0 to 4.0 g of margarine to the bottle. Weigh the bottle to determine the exact dissolved sample weight. Enter the exact mass by re-entering *Sample Parameters* and selecting *Dissolved Sample Size*. Use the numeric keypad to enter the exact mass. Press *Accept* or *Enter*.
- To dissolve the margarine, mix for 20 to 30 minutes. The resulting solution will be used to determine the water content.

Note: Titrate the solution immediately.

Titration Procedure:

- Setup titrator according to the instruction manual.
- Press "*Select Method*" from the main screen. Use the arrow keys to highlight 'HI8107EN Moisture in Margarine' and press "*Select*".
- Install a 5-mL burette filled with 5 mg/mL One-Component KF Volumetric Titrant and verify that no air bubbles are present in the burette or tubing. If necessary prime until all air has been removed completely.
For the determination of the exact concentration of the titrant follow **HI8001EN 5.0 mg/mL Titrant Standardization using Liquid Water Standard.**
- Connect the solvent bottle top assembly to the bottle of methanol according to the manual.
- Prepare the titration vessel according to the manual. Dispense enough solvent from the solvent bottle to fill the vessel to the "min" line (about 50 mL).
- Press "Start/Stop" to pre-titrate the titration solvent and the titration vessel moisture. Allow the background drift rate to stabilize before proceeding to the next step.
- Fill the syringe and needle with the sample solution.
- Weigh the syringe, needle and sample solution.
- Press "*Start Analysis*". You will be prompted to enter the sample size.
- Dispense 0.5000 g to 1.0000 g of sample solution into the titration vessel through the septum using the needle. Pay attention not to get any sample on the electrode or beaker walls. If necessary swirl the titration vessel by hand.
- Clear the needle of residual sample by intaking a small volume of air from the titration vessel. If a "hanging drop" of sample is seen on the end of the needle, dip the end of the needle briefly in the solvent.
- Remove the needle from the titration vessel and weigh the syringe again in order to determine the added sample mass (by difference of the two measurements.)
- Use the numeric keypad to enter the exact weight and press "*Enter*" to start the analysis.
- At the end of the titration the "Sample Analysis Result" screen is displayed. The results are expressed in % **mass** of water.
- The use of external dissolution increases the precision and drastically lowers the load of the solvent, allowing you to run more titrations without changing the solvent. Use fresh solvent after every 12 - 16 titrations.

Moisture Determination in Margarine

by external dissolution

Method Parameters:

Name: Moisture in Margarine
 Method Revision: 1.0
 Type: Sample Analysis
 Predispensing Amount: None
 Pre-Analysis Stir Time: 10 Sec
 Stirring Speed: 900 RPM
 Stirbar Type: Medium
 Drift Entry: Automatic
 Solvent: Methanol
 Sample Parameters:
 Sample Determ.: External Extraction
 Sample Name: Margarine
 Sample Size: 0.7500 g
 External Solvent Size: 40.0000 g
 External Solvent Conc.: 0.0100 %
 Extracted Sample Size: 3.0000 g
 Titrant: Composite 5
 Titrant Type: One Component
 Nominal Titrant Conc.: 5.0000 mg/mL
 Std. Titrant Conc.: 5.0000 mg/mL
 Date/Time: Jan 1, 2011 12:00
 Titrant Age Reminder: 2d:00h:00m
 Control Parameters:
 Start Mode: Normal
 Standby Mode: Enabled
 Standby Duration: 720 minutes
 Imposed Current: 20 uA
 Minimum Dose: 1.0000 uL
 Maximum Dose: 50.0000 uL
 Timed Increment: 1 second
 End Point Value: 180.0 mV
 Signal Averaging: 3 Readings
 Flow Rate: 10.0 mL/min
 Termination Parameters:
 Maximum Duration: 720 sec
 Maximum Titrant Volume: 10.0000 mL
 Term. Criterion: Relative Drift
 Relative Drift: 15.0 ug/min
 Result Unit: %

Results:

Titration Report

Method Name: Moisture in Margarine
 Time & Date: 12:00 Jan 01, 2011
 Sample Size: 0.7402 g
 Std. Titrant Conc.: 5.0000 mg/mL
 Drift Value: 4.1 ug/min
 End Point Volume: 3.1402 mL
 External Solvent Size: 39.9262 g
 External Solvent Conc.: 0.0141 %
 External Sample Size: 3.1118 g
 Result: 27.6339 %
 Titration Duration: 5:30 [mm:ss]
 Estimated Cell Volume: 64.4 mL
 Titration went to Completion
 Operator Name:
 Analyst Signature: _____

Calculations:

Titrant units: mg/mL
 Titrant volume consumed: V (mL)
 Final results units: % Mass
 Titrant concentration: 5.0000 mg/mL
 External Solvent Size: 40.0000 g
 External Solvent Conc.: 0.0100 %
 External Sample Size: 3.0000 g
 Sample mass: 0.7500 g

$$\% \text{ Mass} = \frac{40.0000}{3.0000} \times \frac{\left(\frac{5.0000 \times V}{0.7500 \times 10}\right) - 0.0100}{100 - \left(\frac{5.0000 \times V}{0.7500 \times 10}\right)} \times 100$$

Moisture Determination in Mayonnaise

by external extraction

Description:

Method for the determination of moisture in Mayonnaise by external extraction. The results are expressed in % mass and should be between 40 and 60 %.

Electrode:

- HI 76320 Double Platinum Pin Electrode

Reagents:

- 5 mg/mL One-Component KF Volumetric Titrant
- Solvent for KF Volumetric Titration
- Dry Methanol

Other Accessories:

- A clean, dry 1-mL syringe
- A clean, dry 22-gauge, 6" non-coring septum penetration needle
- GL 45-Thread Solvent Bottle
- 100-mL extraction bottle with septum
- Magnetic stirrer and stirbar

External Extraction Procedure:

- To an external extraction bottle with septum add magnetic stir bar. Weigh the bottle and record this value.
- Add 40 g of dry methanol to the bottle and stir for 5 minutes.
- Determine the moisture content of the solvent mix. For the determination of the exact concentration of the solvent mix, follow **HI8301EN Solvent w/ 5mg/mL 1-comp.**
- Enter the solvent moisture concentration by pressing *Method Options*, then *Sample Parameters*, then *External Solvent Concentration*. Use the numeric keypad to enter the exact concentration. Press *Accept* or *Enter*.
- Weigh the extraction bottle to determine the weight of the remaining solvent (by subtracting the empty bottle mass). Enter the exact mass by re-entering *Sample Parameters* and selecting *External Solvent Size*. Use the numeric keypad to enter the exact mass. Press *Accept* or *Enter*.
- Add 0.8 to 1.2 g of mayonnaise to the bottle. Weigh the bottle to determine the exact extracted sample weight. Enter the exact mass by re-entering *Sample Parameters* and selecting *Extracted Sample Size*. Use the numeric keypad to enter the exact mass. Press *Accept* or *Enter*.
- To extract the water from the mayonnaise, mix for 20 to 30 minutes. The resulting supernatant will be used to determine the water content.

Note: Titrate the supernatant immediately.

Titration Procedure:

- Setup titrator according to the instruction manual.
- Press "*Select Method*" from the main screen. Use the arrow keys to highlight 'HI8108EN Moisture in Mayonnaise' and press "*Select*".
- Install a 5-mL burette filled with 5 mg/mL One-Component KF Volumetric Titrant and verify that no air bubbles are present in the burette or tubing. If necessary prime until all air has been removed completely.
For the determination of the exact concentration of the titrant follow **HI8001EN 5.0 mg/mL Titrant Standardization using Liquid Water Standard.**
- Connect the solvent bottle top assembly to the bottle of methanol according to the manual.
- Prepare the titration vessel according to the manual. Dispense enough solvent from the solvent bottle to fill the vessel to the "min" line (about 50 mL).
- Press "Start/Stop" to pre-titrate the titration solvent and the titration vessel moisture. Allow the background drift rate to stabilize before proceeding to the next step.
- Stop stirring the sample in the extraction bottle and allow any particulate matter to settle.
- Fill the syringe and needle with the supernatant. Do not draw particulate from the bottom.
- Weigh the syringe, needle and supernatant.
- Press "*Start Analysis*". You will be prompted to enter the sample size.
- Dispense 0.5000 g to 1.0000 g of supernatant into the titration vessel through the septum using the needle. Pay attention not to get any sample on the electrode or beaker walls. If necessary swirl the titration vessel by hand.
- Clear the needle of residual sample by intaking a small volume of air from the titration vessel. If a "hanging drop" of sample is seen on the end of the needle, dip the end of the needle briefly in the solvent.
- Remove the needle from the titration vessel and weigh the syringe again in order to determine the added sample mass (by difference of the two measurements.)
- Use the numeric keypad to enter the exact weight and press "*Enter*" to start the analysis.
- At the end of the titration the "Sample Analysis Result" screen is displayed. The results are expressed in % **mass** of water.
- The use of external extraction increases the precision and drastically lowers the load of the solvent, allowing you to run more titrations without changing the solvent. Use fresh solvent after every 10 - 12 titrations.

Moisture Determination in Mayonnaise

by external extraction

Method Parameters:

Name: Moisture in Mayonnaise
 Method Revision: 1.0
 Type: Sample Analysis
 Predispensing Amount: None
 Pre-Analysis Stir Time: 10 Sec
 Stirring Speed: 900 RPM
 Stirbar Type: Medium
 Drift Entry: Automatic
 Solvent: Methanol
 Sample Parameters:
 Sample Determ.: External Extraction
 Sample Name: Mayonnaise
 Sample Size: 0.7500 g
 External Solvent Size: 40.0000 g
 External Solvent Conc.: 0.0100 %
 Extracted Sample Size: 1.0000 g
 Titrant: Composite 5
 Titrant Type: One Component
 Nominal Titrant Conc.: 5.0000 mg/mL
 Std. Titrant Conc.: 5.0000 mg/mL
 Date/Time: Jan 1, 2011 12:00
 Titrant Age Reminder: 2d:00h:00m
 Control Parameters:
 Start Mode: Normal
 Standby Mode: Enabled
 Standby Duration: 720 minutes
 Imposed Current: 20 uA
 Minimum Dose: 0.5000 uL
 Maximum Dose: 20.0000 uL
 Timed Increment: 1 second
 End Point Value: 180.0 mV
 Signal Averaging: 3 Readings
 Flow Rate: 10.0 mL/min
 Termination Parameters:
 Maximum Duration: 720 sec
 Maximum Titrant Volume: 10.0000 mL
 Term. Criterion: Relative Drift
 Relative Drift: 10.0 ug/min
 Result Unit: %

Results:

Titration Report

Method Name: Moisture in Mayonnaise
 Time & Date: 12:00 Jan 01, 2011
 Sample Size: 0.7500 g
 Std. Titrant Conc.: 5.0000 mg/mL
 Drift Value: 4.6 ug/min
 End Point Volume: 2.2010 mL
 External Solvent Size: 40.0000 g
 External Solvent Conc.: 0.0100 %
 External Sample Size: 1.0000 g
 Result: 58.9770 %
 Titration Duration: 7:18 [mm:ss]
 Estimated Cell Volume: 60.0 mL
 Titration went to Completion
 Operator Name:
 Analyst Signature: _____

Calculations:

Titrant units: mg/mL
 Titrant volume consumed: V (mL)
 Final results units: % Mass
 Titrant concentration: 5.0000 mg/mL
 External Solvent Size: 40.0000 g
 External Solvent Conc.: 0.0100 %
 External Sample Size: 1.0000 g
 Sample mass: 0.7500 g

$$\% \text{ Mass} = \frac{40.0000}{1.0000} \times \frac{\left(\frac{5.0000 \times V}{0.7500 \times 10}\right) - 0.0100}{100 - \left(\frac{5.0000 \times V}{0.7500 \times 10}\right)} \times 100$$

Moisture Determination in Shampoo

Description:

Method for the determination of water in Shampoo. The results are expressed in % mass and should be between 70 and 90 %.

Electrode:

- HI 76320 Double Platinum Pin Electrode

Reagents:

- 5 mg/mL One-Component KF Volumetric Titrant
- Dry Methanol

Other Accessories:

- A clean, dry 1-mL syringe
- A clean, dry 18-gauge, 6" non-coring septum penetration needle
- GL 45-Thread Solvent Bottle

Procedure:

- Setup titrator according to the instruction manual.
- Press "*Select Method*" from the main screen. Use the arrow keys to highlight 'HI8201EN Moisture in Shampoo' and press "*Select*".

- Install a 5-mL burette filled with 5 mg/mL One-Component KF Volumetric Titrant and verify that no air bubbles are present in the burette or tubing. If necessary prime until all air has been removed completely.

For the determination of the exact concentration of the titrant follow **HI8001EN 5.0 mg/mL Titrant Standardization using Liquid Water Standard**.

- Connect the solvent bottle top assembly to the bottle of methanol according to the manual.
- Prepare the titration vessel according to the manual. Dispense enough solvent from the solvent bottle to fill the vessel to the "min" line (about 50 mL).
- Press "Start/Stop" to pre-titrate the solvent and the titration vessel moisture. Allow the background drift rate to stabilize before proceeding to the next step.
- Fill the syringe and needle with the sample.
- Weigh the syringe, needle and shampoo.
- Press "*Start Analysis*". You will be prompted to enter the sample size.
- Dispense 0.0150 g to 0.0200 g of shampoo into the titration vessel through the septum using the needle. Pay attention not to get any sample on the electrode or beaker walls. If necessary swirl the titration vessel by hand.
- Clear the needle of residual sample by intaking a small volume of air from the titration vessel. If a "hanging drop" of sample is seen on the end of the needle, dip the end of the needle briefly in the solvent.
- Remove the needle from the titration vessel and weigh the syringe again in order to determine the

added sample mass (by difference of the two measurements.)

- Use the numeric keypad to enter the exact weight and press "*Enter*" to start the analysis.
- At the end of the titration the "Sample Analysis Result" screen is displayed. The results are expressed in % **mass** of water.

Method Parameters:

Name:	Moisture in Shampoo
Method Revision:	1.0
Type:	Sample Analysis
Predispensing Amount:	40 %
Pre-Analysis Stir Time:	15 Sec
Stirring Speed:	900 RPM
Stirbar Type:	Medium
Drift Entry:	Automatic
Solvent:	Methanol
Sample Parameters:	
Sample Determ.:	Normal
Sample Name:	Shampoo
Sample Type:	Mass
Sample Size:	0.0200 g
Titrant:	Composite 5
Titrant Type:	One Component
Nominal Titrant Conc.:	5.0000 mg/mL
Std. Titrant Conc.:	5.0000 mg/mL
Date/Time:	Jan 1, 2011 12:00
Titrant Age Reminder:	2d:00h:00m
Control Parameters:	
Start Mode:	Normal
Standby Mode:	Enabled
Standby Duration:	720 minutes
Imposed Current:	20 uA
Minimum Dose:	0.5000 uL
Maximum Dose:	20.0000 uL
Timed Increment:	1 second
End Point Value:	180.0 mV
Signal Averaging:	3 Readings
Flow Rate:	10.0 mL/min
Termination Parameters:	
Maximum Duration:	600 sec
Maximum Titrant Volume:	10.0000 mL
Term. Criterion:	Relative Drift
Relative Drift:	10.0 ug/min
Result Unit:	%

Calculations:

Titrant units:	mg/mL
Titrant volume consumed:	V (mL)
Final results units:	% Mass
Titrant concentration:	5.0000 mg/mL
Sample mass:	0.0200 g

$$\% \text{ Mass} = \frac{V \times 5.0000}{0.0200 \times 10}$$

Moisture Determination in Shampoo

Results:

Titration Report

Method Name: Moisture in Shampoo
Time & Date: 12:00 Jan 1, 2011
Sample Size: 0.0200 g
Std. Titrant Conc.: 5.0000 mg/mL
Drift Value: 5.4 ug/min
End Point Volume: 3.2010 mL
Result: 79.9207 %
Titration Duration: 7:19 [mm:ss]
Estimated Cell Volume: 106.37 mL
Titration went to Completion
Operator Name:
Analyst Signature: _____

Moisture Determination in Hand Cream

Description:

Method for the determination of moisture in Hand Cream. The results are expressed in % mass and should be between 50 and 75 %.

Electrode:

- HI 76320 Double Platinum Pin Electrode

Reagents:

- 5 mg/mL One-Component KF Volumetric Titrant
- Dry Methanol
- Dry Chloroform

Other Accessories:

- A clean, dry 1-mL syringe
- A clean, dry 18-gauge, 6" non-coring septum penetration needle
- GL 45-Thread Solvent Bottle

Procedure:

- Setup titrator according to the instruction manual.
- Press "*Select Method*" from the main screen. Use the arrow keys to highlight 'HI8202EN Moisture in Hand Cream' and press "*Select*".
- Install a 5-mL burette filled with 5 mg/mL One-Component KF Volumetric Titrant and verify that no air bubbles are present in the burette or tubing. If necessary prime until all air has been removed completely.
For the determination of the exact concentration of the titrant follow **HI8001EN 5.0 mg/mL Titrant Standardization using Liquid Water Standard**.
- Prepare at least 200 mL of solvent by adding 2 parts dry chloroform to 1 part dry methanol in a solvent bottle. Attach the solvent bottle top assembly to the bottle according to the instruction manual.
- Prepare the titration vessel according to the manual. Dispense enough solvent from the solvent bottle to fill the vessel to the "min" line (about 50 mL).
- Press "Start/Stop" to pre-titrate the solvent and the titration vessel moisture. Allow the background drift rate to stabilize before proceeding to the next step.
- Fill the syringe and needle with the sample.
- Weigh the syringe, needle and shampoo.
- Press "*Start Analysis*". You will be prompted to enter the sample size.
- Dispense 0.0200 g to 0.0250 g of hand cream into the titration vessel through the septum using the needle. Pay attention not to get any sample on the electrode or beaker walls. If necessary swirl the titration vessel by hand.
- Clear the needle of residual sample by intaking a small volume of air from the titration vessel. If a "hanging drop" of sample is seen on the end of the

needle, dip the end of the needle briefly in the solvent.

- Remove the needle from the titration vessel and weigh the syringe again in order to determine the added sample mass (by difference of the two measurements.)
- Use the numeric keypad to enter the exact weight and press "*Enter*" to start the analysis.
- At the end of the titration the "Sample Analysis Result" screen is displayed. The results are expressed in % **mass** of water.

Method Parameters:

Name:	Moisture in Hand Cream
Method Revision:	1.0
Type:	Sample Analysis
Predispensing Amount:	40 %
Pre-Analysis Stir Time:	15 Sec
Stirring Speed:	900 RPM
Stirbar Type:	Medium
Drift Entry:	Automatic
Solvent:	CHCl ₃ MeOH 2:1
Sample Parameters:	
Sample Determ.:	Normal
Sample Name:	Hand Cream
Sample Type:	Mass
Sample Size:	0.0200 g
Titrant:	Composite 5
Titrant Type:	One Component
Nominal Titrant Conc.:	5.0000 mg/mL
Std. Titrant Conc.:	5.0000 mg/mL
Date/Time:	Jan 1, 2011 12:00
Titrant Age Reminder:	2d:00h:00m
Control Parameters:	
Start Mode:	Normal
Standby Mode:	Enabled
Standby Duration:	720 minutes
Imposed Current:	20 uA
Minimum Dose:	0.500 uL
Maximum Dose:	20.000 uL
Timed Increment:	1 second
End Point Value:	180.0 mV
Signal Averaging:	3 Readings
Flow Rate:	10.0 mL/min
Termination Parameters:	
Maximum Duration:	900 sec
Maximum Titrant Volume:	10.0000 mL
Term. Criterion:	Relative Drift
Relative Drift:	10.0 ug/min
Result Unit:	%

Calculations:

Calculations:	
Titrant units:	mg/mL
Titrant volume consumed:	V (mL)
Final results units:	% Mass
Titrant concentration:	5.0000 mg/mL
Sample mass:	0.0200 g

$$\% \text{ Mass} = \frac{V \times 5.0000}{0.0200 \times 10}$$

Moisture Determination in Hand Cream

Results:

Titration Report

Method Name: Moisture Hand Cream
Time & Date: 12:00 Jan 1, 2011
Sample Size: 0.0244 g
Std. Titrant Conc.: 5.0000 mg/mL
Drift Value: 5.4 ug/min
End Point Volume: 2.6925 mL
Result: 67.3125 %
Titration Duration: 6:48 [mm:ss]
Estimated Cell Volume: 106.37 mL
Titration went to Completion
Operator Name:
Analyst Signature: _____

Moisture Determination in Solvent with 5 mg/mL Titrant (One-Comp.)

for external dissolution or extraction

Description:

Method for the determination of moisture in extraction/dissolution solvent using 5 mg/mL One-Component Titrant. The results are expressed in % mass and should be less than 0.1%.

Electrode:

- HI 76320 Double Platinum Pin Electrode

Reagents:

- 5 mg/mL One-Component KF Volumetric Titrant
- Dry Methanol

Other Accessories:

- A clean, dry 1-mL syringe
- A clean, dry 22-gauge, 6" non-coring septum penetration needle
- GL 45-Thread Solvent Bottle

Titration Procedure:

- Setup titrator according to the instruction manual.
- Press "*Select Method*" from the main screen. Use the arrow keys to highlight 'HI8301EN Solvent w/ 5mg/mL 1-comp.' and press "*Select*".
- Install a 5-mL burette filled with 5 mg/mL One-Component KF Volumetric Titrant and verify that no air bubbles are present in the burette or tubing. If necessary prime until all air has been removed completely.

For the determination of the exact concentration of the titrant, follow **HI8001EN 5.0 mg/mL Titrant Standardization using Liquid Water Standard**.

- Connect the solvent bottle top assembly to the bottle of methanol according to the manual.
- Prepare the titration vessel according to the manual. Dispense enough solvent from the solvent bottle to fill the vessel to the "min" line (about 50 mL).
- Press "Start/Stop" to pre-titrate the solvent and the titration vessel moisture. Allow the background drift rate to stabilize before proceeding to the next step.
- Stop stirring the solvent in the extraction/dissolution bottle.
- Fill the syringe and needle with the extraction/dissolution solvent.
- Weigh the syringe, needle and solvent.
- Press "*Start Analysis*". You will be prompted to enter the sample size.
- Dispense 0.7500 g to 1.0000 g of solvent into the titration vessel through the septum using the needle. Pay attention not to get any solvent on the electrode or beaker walls. If necessary swirl the titration vessel by hand.
- Clear the needle of residual solvent by intaking a small volume of air from the titration vessel. If a "hanging drop" of solvent is seen on the end of the

needle, dip the end of the needle briefly in the titration solvent.

- Remove the needle from the titration vessel and weigh the syringe again in order to determine the added sample mass (by difference of the two measurements.)
- Use the numeric keypad to enter the exact weight and press "*Enter*" to start the analysis.
- At the end of the titration the "Sample Analysis Result" screen is displayed. The results are expressed in % **mass** of water. Record this value as the "External Solvent Concentration".

Method Parameters:

Name: Solvent w/ 5mg/mL 1-comp.
 Method Revision: 1.0
 Type: Sample Analysis
 Predispensing Amount: None
 Pre-Analysis Stir Time: 0 Sec
 Stirring Speed: 900 RPM
 Stirbar Type: Medium
 Drift Entry: Automatic
 Solvent: Methanol

Sample Parameters:
 Sample Determ.: Normal
 Sample Name: Solvent
 Sample Type: Mass
 Sample Size: 1.0000 g

Titrant:
 Titrant Type: One Component
 Nominal Titrant Conc.: 5.0000 mg/mL
 Std. Titrant Conc.: 5.0000 mg/mL
 Date/Time: Jan 1, 2011 12:00
 Titrant Age Reminder: 2d:00h:00m

Control Parameters:
 Start Mode: Cautious
 Standby Mode: Enabled
 Standby Duration: 720 minutes
 Imposed Current: 20 uA
 Minimum Dose: 0.2500 uL
 Maximum Dose: 5.0000 uL
 Timed Increment: 1 second
 End Point Value: 180.0 mV
 Signal Averaging: 3 Readings
 Flow Rate: 10.0 mL/min

Termination Parameters:
 Maximum Duration: 600 sec
 Maximum Titrant Volume: 5.0000 mL
 Term. Criterion: Relative Drift
 Relative Drift: 10.0 ug/min

Result Unit: %

Calculations:

Titrant units: mg/mL
 Titrant volume consumed: V (mL)
 Final results units: % Mass
 Titrant concentration: 5.0000 mg/mL
 Sample mass: 1.0000 g

$$\% \text{ Mass} = \frac{V \times 5.0000}{1.0000 \times 10}$$

Moisture Determination in Solvent with 5 mg/mL Titrant (One-Comp.)
for external dissolution or extraction

Results:

Titration Report

Method Name: Solvent w/ 5mg/mL 1-comp.
Time & Date: 12:00 Jan 01, 2011
Sample Size: 0.9580 g
Std. Titrant Conc.: 5.0000 mg/mL
Drift Value: 4.0 ug/min
End Point Volume: 0.1157 mL
Result: 0.0595 %
Titration Duration: 2:06 [mm:ss]
Estimated Cell Volume: 57.5 mL
Titration went to Completion
Operator Name:
Analyst Signature: _____

TITRATION THEORY
Principles
HI 903
KARL FISCHER
VOLUMETRIC TITRATOR

Revision 1.0

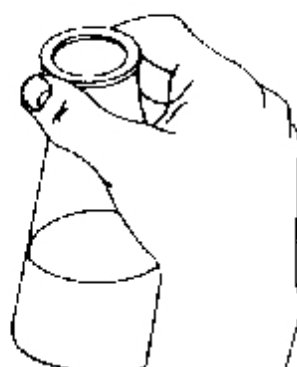
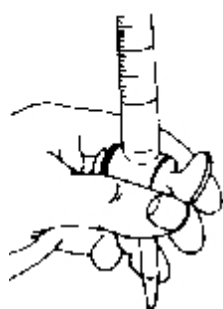

TITRATION THEORY

Contents

1	GENERAL REVIEW OF TITRATION THEORY	5
1.1	Introduction to Titrations	5
1.2	Uses of Titrations	5
1.3	Advantages and Disadvantages of Titrations	6
2	TYPES OF TITRATION	7
2.1	Titrations According to The Measurement Method	7
2.1.1	Amperometric Titrations	7
2.1.2	Potentiometric Titrations	7
2.1.3	Spectrophotometric Titrations	8
2.2	Titrations According to The Reaction Type	9
2.2.1	Karl Fischer Titration	9
2.2.1.1	History of Karl Fischer Titrations	9
2.2.1.2	Visual Indication of Karl Fischer Titrations	10
2.2.1.3	Electrometric Indication of Karl Fischer Titrations	10
2.2.2	Acid - Base Titrations	11
2.2.3	Argentometric Titrations	12
2.2.4	Complexometric Titrations	12
2.2.5	Ion Selective Titrations	13
2.2.6	Non-aqueous Solvent Acid - Base Titrations	13
2.2.7	Precipitation Titrations	14
2.2.8	Redox Titrations	14
2.3	Titrations According to The Titration Sequence	15
2.3.1	Back Titrations	15
2.3.2	Multiple End Point Titrations	15
3	INTRODUCTION TO TITRATION APPARATUS AND TYPICAL TITRATION PROCEDURE	17
3.1	Manual Titration	17
3.2	Automatic Titration	18
4	TITRATION RESULTS	19
4.1	Accuracy	19
4.2	Repeatability	19
4.3	Sources of Error	19
4.3.1	Sampling Errors	19
4.3.2	Errors with Titrant and Standard	19
4.3.2.1	Preparation Errors	19
4.3.2.2	Dispensing Errors	20
4.3.3	Chemical Reaction Errors	20
4.3.4	End Point Determination Errors	20
5	CALCULATIONS	21
5.1	Equations Used in Karl Fischer Titrations	21
5.1.1	Calculation of water content as % mass from samples measured by mass	21
5.1.2	Calculation of water content as % mass from samples measured by volume	21
5.1.3	Calculation of water content as % volume from samples measured by volume	21
5.1.4	Calculation of water content subtracting Background Drift Rate	21
5.1.5	Calculation of water content in external dissolutions samples	22
5.1.6	Calculation of water content in external extraction samples	22
5.1.7	Calculation of water content in gaseous samples	22
5.1.8	Calculation of Titer (water equivalent of the titrant) using sodium tartrate dihydrate containing 15.66% water by mass	22
5.1.9	Calculation of Titer (water equivalent of the titrant) using water standards	23
5.2	Equations Used in Titrations	23
5.2.1	Sample Calculation	23
5.2.2	Standardize Titrant	23
5.2.3	Blank Titration	24
5.2.4	Multiple End Point Titration	24
5.2.5	Back Titration	25
6	GLOSSARY	26

TITRATION THEORY

1 GENERAL REVIEW OF TITRATION THEORY

1.1 Introduction to Titrations

A titration is a quantitative, volumetric procedure used in analytical chemistry to determine the concentration of an analyte (the species being measured) in solution. The concentration of the analyte is determined by slowly adding a titrant (reagent) to the solution. As the titrant is added, a chemical reaction occurs between the titrant and the analyte.

Titration reactions are relatively fast, simple reactions that can be expressed using a chemical equation. The titration reaction continues as the titrant is added until all of the analyte is consumed and the analyte reacts completely and quantitatively with the titrant.

The point at which all of the analyte has been reacted is called the equivalence point, also known as the theoretical or stoichiometric endpoint. This point is accompanied by an abrupt physical change in the solution, which sharply defines the endpoint of the reaction. The physical change associated with the titration endpoint can be produced by the titrant or an indicator and can be detected either visually or by some other physical measurement.

Titration cannot be used to determine the quantity of all analytes. The chemical reaction between the titrant and analyte must fulfill four requirements:

- The reaction must be fast and occur within approximately one second after the titrant is added;
- The reaction must go to completion;
- The reaction must have well-known stoichiometry (reaction ratios);
- A convenient endpoint or inflection point.

Titration is highly precise and can provide many advantages over alternative methods. Titrations are quickly performed and require relatively simple apparatus and instrumentation.

1.2 Uses of Titrations

Titration can be used in many applications, including:

- Acid content of plant effluents, food (i.e. cheese and wine), plating and etching baths, petroleum products, drugs;
- Base content of fertilizer (containing ammonia), bleach, minerals;
- Hardness in water;
- Metal content of alloys, minerals, ores, clays, waters, plating baths, paints, paper, plant materials, biological fluids, petroleum products;
- Moisture content in butter, dairy cream, food grade oil, honey, margarine, mayonnaise, milk, powdered milk, sugar;
- Redox reagent concentrations such as available chlorine in potable water, peroxide, traces of oxidants and reductants in food, reductants in high temperature or high pressure boiler water, vitamin analysis.

TITRATION THEORY

1.3 Advantages and Disadvantages of Titrations

Some advantages of titrations, as an analytical technique, are:

- More precise results than many instrumental methods, such as measurement by electrode, the accuracy of the measurement is up to 0.1%;
- Simple methods, reasonable capital costs, and easy training;
- Suitability to measure major components of a mixture or product;
- Automation can reduce time and labor spent on each analysis.

Some disadvantages of titrations are:

- Time it takes to prepare standards and titrants;
- Good technique is required to achieve precise results (training and practice required);
- Not suitable for determining trace or minor components of a mixture or product;
- Limited dynamic range, it may require additional sample preparations (dilution) and repeat analyses.

2 TYPES OF TITRATIONS

2.1 Titrations According to The Measurement Method

2.1.1 Amperometric Titrations

An amperometric titration is performed by placing two electrodes (often a metal electrode and a reference electrode) into the sample solution and holding the potential of the metal electrode at a selected voltage. The current that flows, due to the oxidation or reduction of a reactant or product, is plotted vs. volume of titrant to provide the titration curve and locate the equivalence point. Changes in the current are due to changes in the concentration of a particular species (being oxidized or reduced at the electrode).

Generally the reaction between the analyte and titrant forms a new species. Depending on the titration, the reactants are electroactive and the products are not, or vice-versa. Amperometric titration curves look like two straight lines intersecting at the equivalence point, this is due to the change in the electroactivity of the solution.

Many metal ions can be amperometrically titrated using a precipitation, complexation or redox reaction. Some metal ions and species that can be determined in this manner include silver, barium, halides, potassium, magnesium, palladium, molybdate, sulfate, tungstate, zinc, bismuth, cadmium, fluoride, indium, thallium, iodine, and gold.

Figure 1 shows four amperometric titrations and their endpoints. In graph "A" the analyte is electroactive and gives current but the reacted species does not. In "B" the reactant is not active but the titrant is. In "C" both the analyte and titrant are active and both give current flow. Graph "D" shows the same situation as "B"; however, the current has an opposite sign (the titrant is reduced).

Figure 1.

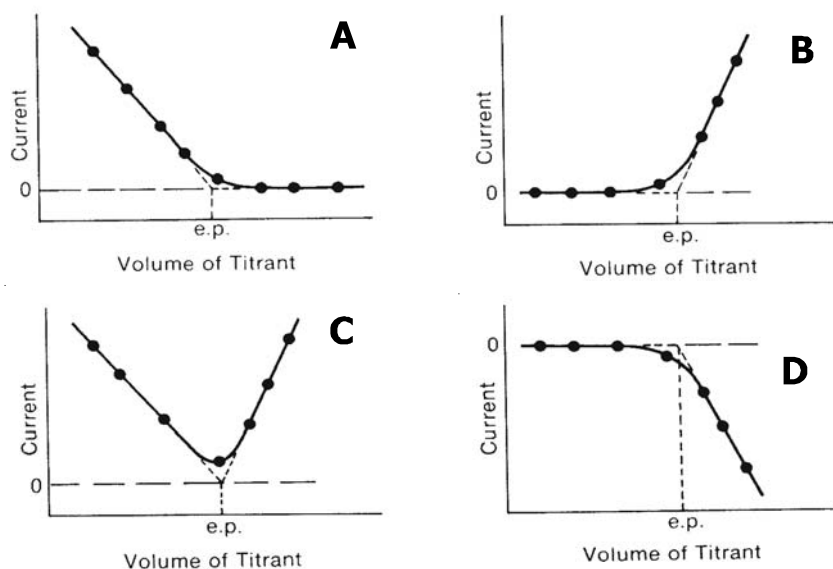

2.1.2 Potentiometric Titrations

Potentiometric titrations are done by measuring the voltage across the solution using an electrode system. An electrode system consists of an indicator electrode and a reference electrode. As titrant is added the variations in the potential of the indicator electrode, with respect to the reference

TITRATION THEORY

electrode, are monitored to show the progress of the titration.

Potentiometry is the measurement of a potential under conditions of zero current flow. The measured potential can then be used to determine the analytical quantity of interest, generally a component concentration of the analyte solution. The potential that develops in the electrochemical cell is the result of the free energy change that would occur if the chemical phenomena were to proceed until the equilibrium condition has been satisfied.

There are many types of titrations where potentiometry can be used, e.g., pH electrodes for acid-base titrations, platinum ORP electrodes in redox titrations, ion selective electrodes, such as chloride or fluoride for a specific ion titration, and silver electrodes for argentometric (silver-based) titrations.

2.1.3 Spectrophotometric Titrations

The name comes from the method used to detect the endpoint of the titration, not its chemistry. Highly colored indicators that change color during the course of the titration are available for many titrations. More accurate data on the titration curve can be obtained if the light absorption is monitored instrumentally using a light source, a simple monochromator and a photodetector, rather than visually determining the color or light absorption change. Light absorption by either an indicator or by one of the reactants or products can be used to monitor the titration.

In the first titration curve, Figure 2 "A", the absorption of a metal-indicator complex is being monitored. The absorption is constant while the metal is complexed by the EDTA titrant. The metal indicator complex was stripped, causing a sharp break in the titration curve. The point where all the metal is complexed and stripped from the indicator is the equivalence point. This point is marked by "e.p." on the graph.

In the second titration curve, Figure 2 "B", the metal complex is being measured while being titrated with EDTA. The new complex being formed is not colored and does not absorb light. The extrapolated intersection of the two lines determines the equivalence point.

Figure 2.

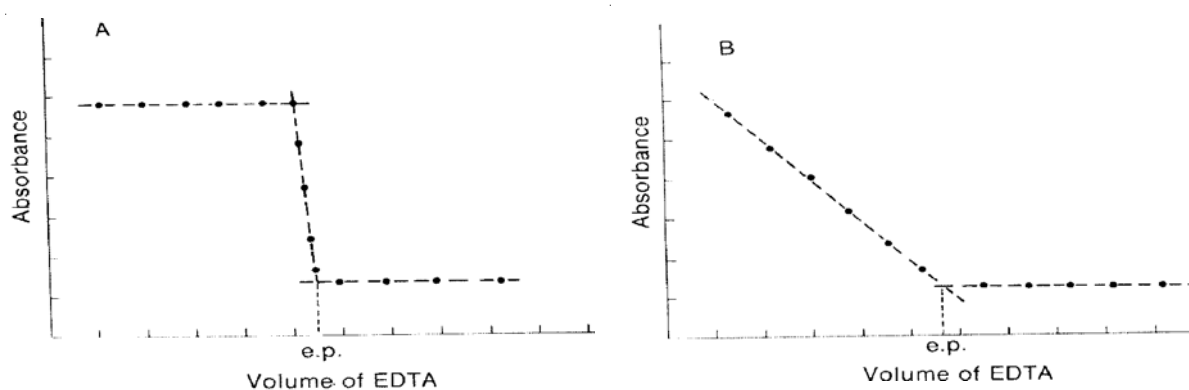

2.2 Titrations According to The Reaction Type

2.2.1 Karl Fischer Titrations

This method is based on a well-defined chemical reaction between water and the Karl Fischer reagent. The chemistry provides excellent specificity for water determination. The method can be used to determine free and bound water in a sample matrix. The Karl Fischer method is widely considered to produce the most rapid, accurate and reproducible results and has the largest detectable concentration range spanning 1 ppm to 100%.

The determination of water content is one of the most commonly practiced methods in laboratories around the world. Knowledge of water content is critical to understanding chemical and physical properties of materials and ascertaining product quality. Water content determination is conducted on many sample types including pharmaceuticals and cosmetics, foods and natural products, organic and inorganic compounds, chemicals, solvents and gases, petroleum and plastic products as well as paints and adhesives. The KF method is verifiable and can be fully documented. As a result, Karl Fischer titration is the standard method for analysis of water in a multitude of samples as specified by numerous organizations including the Association of Official Analytical Chemists, the United States and European Pharmacopoeia, ASTM, American Petroleum Institute, British Standards and DIN.

2.2.1.1 History of Karl Fischer Titrations

Water determination by Karl Fischer titration is based on the reaction described by Bunsen in 1853 in which sulfur dioxide is oxidized by iodine in the presence of water.



In Karl Fischer's 1935 article, "a new procedure for the titration of water," he presented a modified form of the Bunsen reaction adapted for use in determining the water content of non-aqueous solutions. His titrations were conducted in methanol in the presence of excess sulfur dioxide and pyridine in order to neutralize the acidic reaction products and drive the reaction to completion.

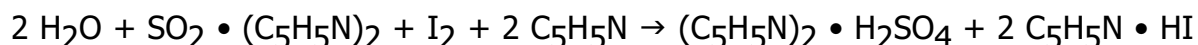

Two key developments have since lead to the currently accepted description of the Karl Fischer reaction. First, pyridine acts as a pH buffer and does not play a direct role in the reaction. This has allowed reagent formulators to replace pyridine with bases which are both less toxic and result in pH ranges that facilitate faster and more accurate titrations. Second, the species that reacts with water is not sulfur dioxide but the monomethyl sulfite ion resulting from the reaction between sulfur dioxide and methanol. Subsequently, researchers showed that higher alcohols can be used in place of methanol. The Karl Fischer reaction can therefore be described by the following generalized reaction sequence in which the H₂O, I₂, SO₂ and RN species react in a 1:1:1:3 stoichiometry.

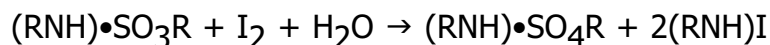

The maximum rate of the Karl Fischer reaction is reached between the pH range of 5.5 to 8 where all of the sulfur dioxide is available as methyl sulfite. If the pH drops below 5, the rate

TITRATION THEORY

of reaction decreases and titration endpoint become increasingly difficult to reach. If the pH exceeds 8, side reactions begin to occur between iodine and hydroxide or methylate ions, changing the titration stoichiometry.

While solvents not containing alcohols can be used for Karl Fischer analysis, they also have an effect on reaction stoichiometry. When alcohols are not present, the reaction resembles the Bunsen reaction stoichiometry where the consumption ratio of water to iodine is 2:1. In solvents containing higher alcohols, uneven ratios can be observed due to the relative abilities of higher alcohols to form the sulfite ester that reacts with water. Issues resulting from solvent-induced variation in stoichiometry are not typically encountered during routine analysis for two reasons. First, titrant standardization and sample analysis are carried out in the same titration medium and under the same conditions, effectively compensating for any variation in reaction behavior. Second, most Karl Fischer reagent system are formulated to support standard KF reaction stoichiometry.

2.2.1.2 Visual Indication of Karl Fischer Titrations

Visual methods, originally used by Karl Fischer, are limited in application, require a high degree of skill and have been made obsolete by electrometric indication. For successful visual indication, titration samples must be colorless. Additionally, the solution coloration varies between polar and non-polar titration media.

After the titration equivalence point all of the water in the titration solution has been reacted. The next drop of titrant added to the solution after the equivalence point contains iodine that will remain in the titration solution. Thereafter, the concentration of iodine in the titration solution increases and the solution develops a yellow, and eventually brown, color. It is difficult, even for an experienced analyst, to generate reproducible endpoint coloration between successive titrations.

2.2.1.3 Electrometric Indication of Karl Fischer Titrations

Biamperometric and bivoltametric indication are the two types of electrometric detection methods commonly used for indication of Karl Fischer titrations. Both methods use either a double platinum pin or a double platinum ring electrode to detect excess iodine in a titration solution. After the titration equivalence point, all of the water in the titration solution has been reacted. The next dose of titrant added to the solution contains iodine, which reacts at the electrode according to the reactions below.

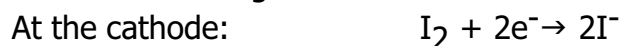

The excess iodine is easily reduced at the cathode, and the resulting iodide is oxidized at the anode.

Both electrometric methods of indication rely on electrons (current) being carried through a titration solution by the oxidation-reduction reactions described above.

Biamperometric indication involves monitoring the flow of current through the titration solution while a constant voltage is applied across the platinum elements of the electrode. When water is present in the titration solution and there is no excess iodine, only a minimal current flows between the electrode elements. After the equivalence point, when iodine is present, the current flow increases to a few μA .

Bivoltametric indication involves measuring the voltage required to maintain a constant current flow between electrode elements. A small direct or alternating current called a polarization current (I_{pol}) is applied between the electrode pins or rings and the resulting voltage is measured in order to monitor the titration progress.

L-shaped titration curves are generated for both methods by plotting either the electrode current or voltage against the volume of titrant added during the titration.

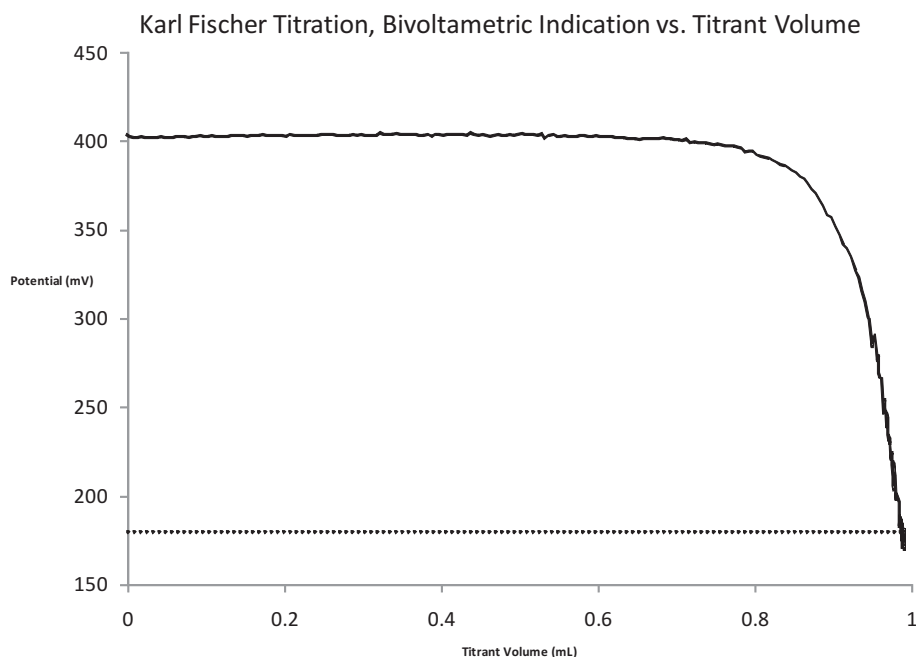

Electrometric methods result in over-titration or titration past the equivalence point where excess iodine is present in the titration solution. Titration past the equivalence point is acceptable for two reasons. First, due to the sensitivity of the electrometric methods, titrations are always carried out to the exact same, slight excess of iodine resulting in highly reproducible titrations. Second, the accuracy of electrometrically indicated titrations are not affected by the over-titration because the slight excess of iodine has been accounted for during the standardization of the titrant.

2.2.2 Acid-Base Titrations

Acid–base titrations are the most common type of titrations. Acid–base titrations are based upon a reaction between an acid and a base, a stoichiometric neutralization, or the exchange of protons. Virtually all acid-base titrations are carried out using a strong acid or a strong base as the titrant. The endpoint of a titration carried out with a weak acid or a weak base, would be difficult to detect due to a small change in pH at the equivalence point.

Chemical indicators are often used to determine the endpoint. The indicator will change color to signify that the end of the titration has been reached. When choosing the proper indicator you should select one that has a pK_a as close to the endpoint of the titration. The color-change region of the indicator is usually ± 1 pH unit around the pK_a . The theoretical titration curve is useful for illustrating how the solution will change during the real titration, and allowing the proper selection of an endpoint or an indicator.

TITRATION THEORY

Figure 3 shows a traditional titration curve. The curve is obtained by plotting the pH value against the volume of NaOH added.

Figure 3

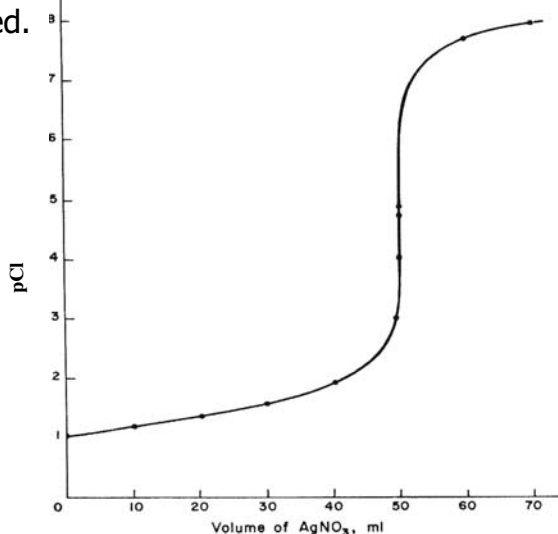

2.2.3 Argentometric Titrations

Argentometric titrations use silver (nitrate) as the titrant and are generally precipitation titrations, as many silver salts are insoluble. These titrations are commonly used to titrate and determine the concentration of bromide, chloride, cyanide, iodide, and sulfide.

Argentometric titrations can be done with Mohr's indicator, when all of the chloride has reacted, a red silver chromate precipitate is formed or the titration can be easily followed with a silver ISE (or chloride ISE for chloride titrations) and a reference electrode.

Figure 4

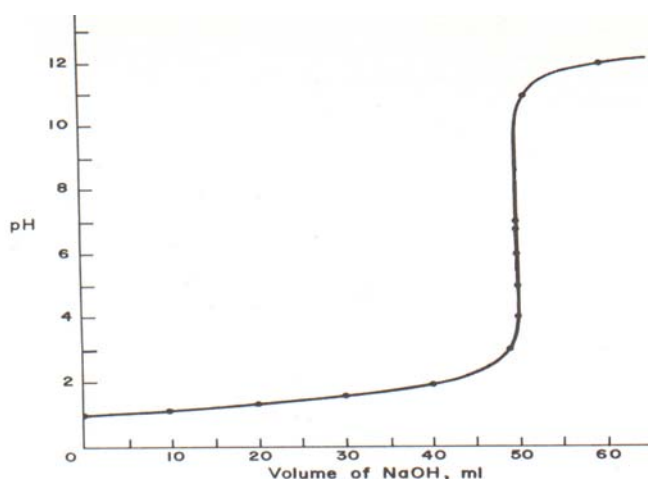

Figure 4 shows the titration of 50 mL of 0.1N NaCl with 0.1N AgNO₃. The potentiometric signal is from a chloride ISE, and is plotted as pCl ($-\log [\text{Cl}^-]$).

2.2.4 Complexometric Titrations

A complex is a species where a central metal ion is covalently bonded to one or more electron donating groups called ligands. In a complexometric titration, metal ions are titrated using a

titrant that binds strongly to it. Often these titrants contain EDTA or CDTA, polydentate ligands that form very stable coordination compounds with metal ions. The complexation reaction must be fast in order to be useful for direct titration. Some metal ions react too slowly with EDTA for a direct titration.

An indicator electrode that responds to the metal ion can be used to monitor the titration progress. The titration curve will appear similar to a usual potentiometric titration. Complexation indicators change color at the endpoint as all metal ions are "consumed", or complexed by the titrant.

The titration curve will appear similar to a potentiometric titration, when using an indicator electrode that responds to the metal ion (see Figure 5).

Figure 5.

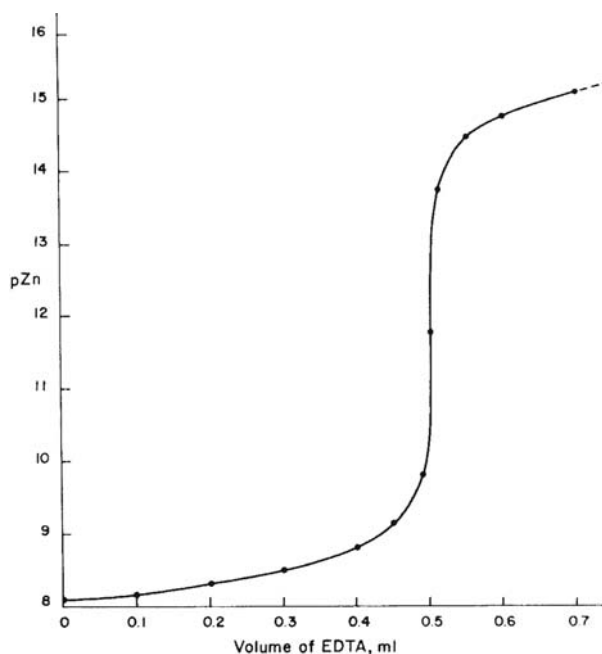

2.2.5 Ion Selective Titrations

The most popular ion selective titration is an acid-base titration. The hydrogen ion concentration is specifically measured and monitored during the titration process to locate the equivalence point. Using an ion selective electrode (ISE) as the indicator electrode, the potentiometric signal (in mV) is used to directly follow a specific ion's concentration (or activity).

Examples of ISE titrations include titrating fluoride with an aluminum titrant using a fluoride ISE, chloride with silver nitrate using a chloride ISE, sodium with a sodium ISE, etc. The equivalence point can be determined by plotting the mV value vs. the amount of titrant added.

2.2.6 Non-aqueous Solvent Acid-Base Titrations

Non-aqueous solvents must be used to titrate very weak acids and bases due to the inherent leveling effect water has on all acids and bases dissolved in it. A wide variety of weak acids and bases can be titrated using non-aqueous solvents. Mixtures of acids or bases can often be individually analyzed in a single sequential titration.

Titration of Acids

Weak acids with pK_a 's up to about 11 can be titrated in non-aqueous solvents. These include

TITRATION THEORY

carboxylic acids, enols, phenols, imides, sulfonic acids, and inorganic acids. Water or lower alcohols are suitable for titrating medium to strong acids (pK_a less than 5). Titrating a weaker acid with a strong base titrant requires a solvent less acidic than water or ethanol/methanol. Solvents such as acetone, acetonitrile, t-butyl alcohol, dimethylformamide, isopropanol and pyridine have been found to work well for acid-base titrations of strong, medium and weak acids/bases. Titrants include alcoholic potassium hydroxide and various sodium or potassium alkoxides in a 10:1 mixture of benzene/methanol. The best titrants are quaternary ammonium hydroxides (such as tetrabutylammonium hydroxide) due to good solubility of tetraalkylammonium salts of the titrated acids and the clean potentiometric titration curve obtained (see Figure 6)

Titration of Bases

Weak bases with pK_b 's up to about 11, which do not ionize with water, can be titrated in non-aqueous solvents. These bases include aliphatic and aromatic amines, basic nitrogen heterocycles, alkali metal and amine salts of acids, and many other organic basic compounds. Titrating a weak base with a strong acid titrant requires a basic solvent that is as weak as possible. Water and alcohols allow the titration of medium strength bases such as aliphatic amines ($pK_b = 4$ to 5), but not the titration of weaker bases such as pyridine ($pK_b = 8.8$). Glacial acetic acid works well for weak bases and has been used extensively. Less basic solvents such as acetone, acetonitrile, and nitromethane extend the range of titrable compounds.

The endpoint for non-aqueous titrations are usually determined potentiometrically using a pH glass electrode, a modified calomel or double junction reference electrode with a low-flow rate reference junction. Good potentiometric titration curves are obtained in most solvents, except those with very low dielectric constants such as benzene, chloroform and others, when high electrical resistance of the solvent causes unstable potentials.

2.2.7 Precipitation Titrations

Precipitation titrations allow for faster analysis compared to the old gravimetric analysis, where a precipitate is formed, filtered, dried and weighed to analyze a compound. Typically silver halides, silver thiocyanate and a few mercury, lead, and zinc salts are titrated using this method. The chemical reactions must form an insoluble salt and precipitate out quickly in order to be analyzed by this method. When the reaction is not quick, a back titration can be used. A measured excess of the precipitating reagent (titrant) is added to force the reaction to occur, and then unreacted titrant is then titrated with a standard solution of another reagent.

2.2.8 Redox Titrations

There are a number of oxidation-reduction reactions that can be used to determine unknown concentration by titration. If the reaction goes to completion, is fast and has an analytical signal available to follow it, a titration can be performed. The term "fast" means that each addition of titrant is reacted completely and the sensing electrode is able to detect the change in solution in less than one second.

Redox titrations are potentiometric titrations where the mV signal from a combination ORP (redox) electrode (usually with a platinum indicator electrode) is used to follow the reaction of oxidant/reductant. The electrode potential is determined by the Nernst equation and is controlled by the

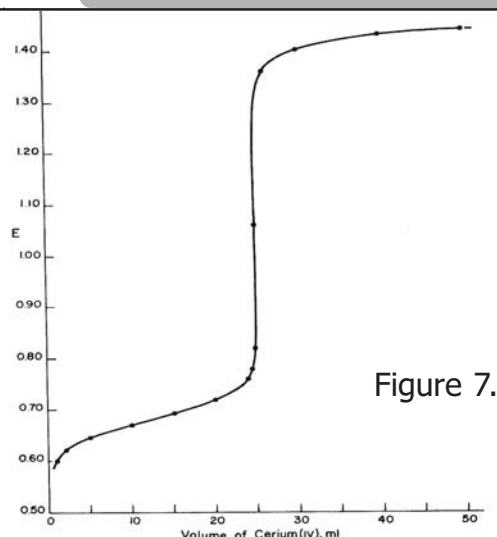
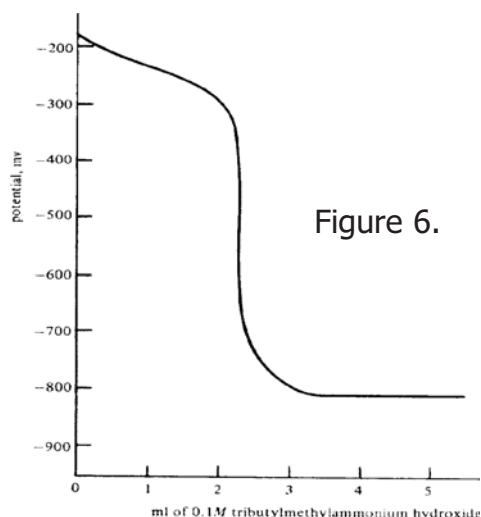

oxidant reductant ratio.

Visual indicators such as Ferrion are also available. The oxidized and reduced form of the indicator will have different colors and can be used to determine the end point.

Various reductants can be determined by titrants with oxidants such as potassium permanganate, potassium chromate or iodine. Commonly used reductants that are used as titrants include sodium thiosulfate, and ferrous ammonium sulfate.

As with Acid-Base titrations the potential changes dramatically at the equivalence point.

2.3 Titrations According to The Titration Sequence

2.3.1 Back Titrations

Back titrations are generally used when a reaction is too slow to be directly accomplished during a "direct" titration, where the reaction goes to completion within a few seconds. In a back titration, a large excess of a reagent is added to the sample solution, helping a slow reaction to go to completion. The un-reacted, excess reagent is then titrated. The difference in the total volume of the first reagent added and amount determined from the second titration is the quantity of reagent required to complete the first reaction.

2.3.2 Multiple End Point Titrations

Under certain conditions, some titrations can exhibit more than one equivalence point and be titratable to the individual end points to determine the concentration of each individual component. Examples of these types of titrations include acid-base, where different strength acid or bases are in a mixture; redox, where each species has a different reduction potential; complexometric, where different species are separately titratable; and acid-base, using polyprotic acids (the pK_a of the different protons varies enough to separate them).

Figure 8 shows three different types of multiple end point titrations. "A" shows the titration of a polyprotic acid. The different acid strengths of the first and second proton can be determined. "B" illustrates a mixture of two different metal redox species, where the different redox potentials allow the species to be separated. "C" is the titration of a solution containing strong, weak, and very weak acids.

TITRATION THEORY

Figure 8.

A

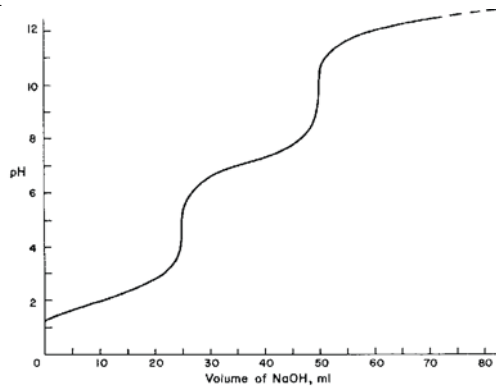

B

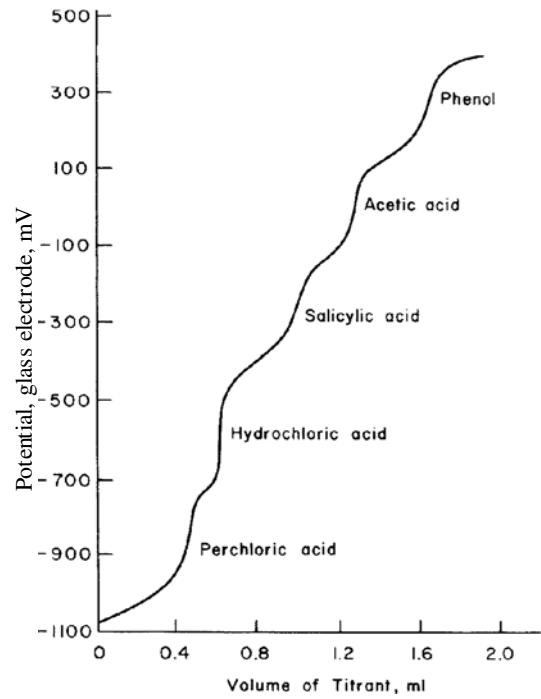
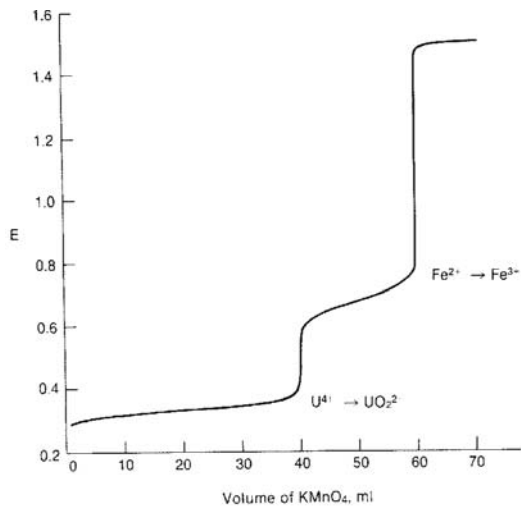

C

3 INTRODUCTION TO TITRATION APPARATUS AND TYPICAL TITRATION PROCEDURE

3.1 Manual Titration

Apparatus required for manual titration include:

- Volumetric Burette, for precisely controlled delivery of titrant to the reaction vessel;
- An Erlenmeyer, or similar flask, that facilitates constant mixing or swirling required to ensure solution homogeneity;
- Volumetric pipettes for the precise addition of samples and indicator solutions;
- Standard titrant solutions of known concentration;
- A visual or instrumental indicator for detecting the completion of the reaction.

A typical manual titration consists of the following steps:

1. A volumetric pipette is typically used to add a known volume of sample to the flask;
2. An indicator solution or instrument probe is added to the flask;
3. A burette is used to measure the addition of titrant to the flask and dispense titrant in a controlled manner;
4. Titrant is added via the burette until the method indication signals the reaction endpoint;
5. The concentration of analyte is calculated based on the concentration and volume of titrant required to reach the endpoint and the reaction stoichiometry.

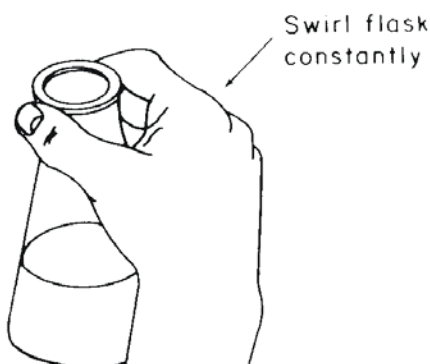
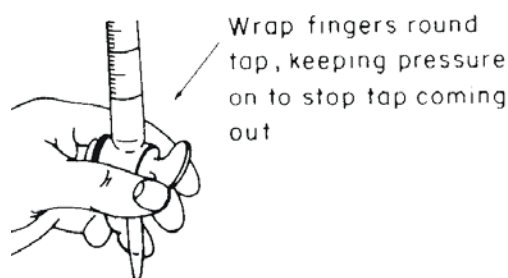

TITRATION THEORY

3.2 Automatic Titration

Automatic titrators are high-precision analytical instruments that deliver the titrant, monitor the physical change associated with the titration reaction, automatically stops at the endpoint and calculates the concentration of the analyte. Automatic titrators are best for repetitive titrations and high-accuracy analyses.

An automatic titrator must have an accurate liquid dispensing system. In high accuracy systems like the HI 900-series titrators, the liquid dispensing system consists of a stepper-motor driven piston syringe burette capable of accurately and precisely dispensing very small volumes of titrant, a valve system to switch between titrant intake and outlet and an anti-diffusion dispensing tip. These three main subsystem components must be as accurate as possible, with very low gear backlash in the burette pump, minimal piston seal flexing, precision ground inner diameter of the glass syringe, a low dead volume valve, minimal evaporation/permeation, and chemically resistant tubing.

Apparatus required for automatic titration include:

- An automatic titrator, equipped with a burette;
- A beaker;
- An electronic stirring system, either a propeller stirrer or a magnetic stir bar and stir plate;
- Volumetric pipettes for the precise addition of samples;
- Standard titrant solutions of known concentration;
- An electrode system that can be used to determine the endpoint of the titration.

A typical automatic titration consists of the following steps:

1. Set up the automatic titrator according to the manufacturer's instructions;
2. A volumetric pipette is typically used to add a known volume of sample to the beaker;
3. Submerge the propeller stirrer or add the stir bar to the beaker, and turn on;
4. Start the titration, the titrator will automatically stop at the endpoint and determine the concentration of the analyte.

4 TITRATION RESULTS

4.1 Accuracy

The factors most critical to achieving accurate results with the HI 900 titration systems are the concentration of the sample, size of the sample and having an optimized set of method parameters.

4.2 Repeatability

Repeatability, or the agreement between replicate determinations, is expressed quantitatively as the relative standard deviation (RSD).

4.3 Sources of Error

One of the advantages of volumetric analysis is excellent accuracy and precision. The sources of error can be grouped into sampling, titrant and standards, chemical reactions, endpoint determination and calculations.

4.3.1 Sampling Errors

- Selection of a non-homogeneous or non-representative sample;
- Sample changed or was contaminated during collection, storage or transfers;
- Poor technique when transferring sample to beaker or flask;
- Errors in the balance, calibrate and check balance regularly.

4.3.2 Errors with Titrant and Standard

4.3.2.1 Preparation Errors

Incorrect preparation due to:

- Poor technique in weighing the salt or when transferring to volumetric glassware;
- Low-purity of salts or water used to make titrant and standard;
- Dirty or wet glassware;
- Improper storage of titrant or standard which allows water gain, evaporation or deterioration;
- Failure to standardize frequently to adjust for change in titrant;
- Failure to flush titrator tubing with a volume of titrant before standardizing;
- Volume errors from pipettes and volumetric flasks, grade A glassware is required;
- Balance errors when weighing out salts, calibrate and check balance regularly.

TITRATION THEORY

4.3.2.2 Dispensing Errors

Incorrect dispensing due to:

- Dead valve volume and leaking valve;
- Inaccuracy in motor drive and gear lash/ backlash;
- Poor burette/ piston seal;
- Non-uniform diameter of burette glass cylinder;
- Chemical incompatibility with tubing or bubble generation;
- Density/ temperature changes in titrant.
- Inadequate volume to cover electrode.

4.3.3 Chemical Reaction Errors

- Inappropriate solvent or sample resulting in side reactions;
- Poor mixing of the titrant and solvent or sample in the titration vessel;
- Reaction between titrant and sample is not rapid;
- Reaction does not go to completion;
- Reaction has side reactions.

4.3.4 Endpoint Determination Errors

Most manual titrations use a visual indicator to indicate when the endpoint is reached and the titration should be stopped. Automatic titrators can use potentiometric electrodes to determine the end of a titration and the equivalence point. There are two predominant methods used to determine the equivalence point, first derivative and second derivative.

The inflection point of a potentiometric curve (mV vs. Volume) is normally assumed to be the equivalence point. The first derivative is often used to determine the inflection point. The maximum value of the first derivative ($D \text{ mV vs. } D V$) corresponds to the theoretical equivalence point. During a titration it is rare to have a data point exactly at the first derivative maximum, the maximum value is determined by interpolating the first derivative data points.

The second derivative ($D^2 \text{ mV vs. } DV^2$) can also be used to determine the equivalence point, and can offer advantages over the first derivative method. Second derivatives have increased sensitivity to smaller inflection points and easier numerical evaluation of the actual equivalence point. The value where the second derivative is equal to zero is the equivalence point. The second derivative requires fewer points located near the equivalence point, where data is often not obtained or not as reliable.

Errors in determining the endpoint can result from:

- Incorrect signals from the sensor;
- Sensor drift;
- Sensor or instrument has slow response, keep sensors in good condition;
- Inappropriate setting on the titrator.

5 CALCULATIONS

5.1 Equations Used in Volumetric Karl Fischer Titrations

5.1.1 Calculation of water content as % mass from samples measured by mass

$$C_{sample} = \frac{V_{titrant} \times Titer}{m_{sample} \times (1000 \text{ mg/g})} \times 100$$

C sample	Concentration of Sample (% w/w)
V titrant	Volume of Titrant (mL)
Titer	Titrant Titer (mg/mL)
m sample	Mass of Sample (g)

5.1.2 Calculation of water content as % mass from samples measured by volume

$$C_{sample} = \frac{V_{titrant} \times Titer}{V_{sample} \times d_{sample} \times (1000 \text{ mg/g})} \times 100$$

C sample	Concentration of Sample (% w/w)
V titrant	Volume of Titrant (mL)
Titer	Titrant Titer (mg/mL)
V sample	Volume of Sample (mL)
d sample	Density of Sample (g/mL)

5.1.3 Calculation of water content as % volume from samples measured by volume

$$C_{sample} = \frac{V_{titrant} \times Titer}{V_{sample} \times d_{water} \times (1000 \text{ mg/g})} \times 100$$

C sample	Concentration of Sample (% v/v)
V titrant	Volume of Titrant (mL)
Titer	Titrant Titer (mg/mL)
V sample	Volume of Sample (mL)
d water	Density of Water at Analysis Temperature (g/mL)

5.1.4 Calculation of water content as % mass subtracting Background Drift Rate

$$C_{sample} = \frac{(V_{titrant} \times Titer) - [Drift \times t \times (1 \text{ mg} / 1000 \mu\text{g})]}{m_{sample} \times (1000 \text{ mg/g})} \times 100$$

C sample	Concentration of Sample (% w/w)
V titrant	Volume of Titrant (mL)
Titer	Titrant Titer (mg/mL)
Drift	Background Drift Rate ($\mu\text{g}/\text{min}$)
t	Titration Duration (min)
m sample	Mass of Sample (g)

TITRATION THEORY

5.1.5 Calculation of water content in External Dissolution Samples

$$C_{\text{sample}} = \left[\frac{m_{\text{solvent}} \times (C_{\text{solution}} - C_{\text{solvent}})}{m_{\text{sample}}} + C_{\text{solution}} \right] \times 100$$

C sample	Concentration of Sample (% w/w)
m solvent	Mass of Solvent (g)
m sample	Mass of Sample (g)
C solution	Water Content of Dissolved Sample (w/w)
C solvent	Water Content of Solvent (w/w)

5.1.6 Calculation of water content in External Extraction Samples

$$C_{\text{sample}} = \frac{m_{\text{solvent}} \times (C_{\text{supernatant}} - C_{\text{solvent}})}{m_{\text{sample}} \times (1 - C_{\text{supernatant}})} \times 100$$

C sample	Concentration of Sample (% w/w)
m solvent	Mass of Solvent (g)
m sample	Mass of Sample (g)
C supernatant	Water Content of Supernatant (w/w)
C solvent	Water Content of Solvent (w/w)

5.1.7 Calculation of water content in Gaseous Samples

The water content of gases is normally reported in units of $\mu\text{g/L}$ or mg/L .

$$C_{\text{sample}} = \frac{V_{\text{titrant}} \times \text{Titer}}{\text{Flow Rate} \times \text{Flow Duration}}$$

C sample	Concentration of Sample (mg/L)
V titrant	Volume of Titrant (mL)
Titer	Titrant Titer (mg/mL)
Flow Rate	Sample Flow Rate (L/min)
Flow Duration	Sample Extraction Time (min)

To calculate the water content in %w/w the mass of the gas introduced into the titration vessel must be known. This can be determined by calculations using ideal gas laws or by measuring the mass of the sample container before and after a titration.

5.1.8 Calculation of titer (water equivalent of the titrant) using sodium tartrate dihydrate containing 15.66% water by mass

$$C_{\text{titrant}} = \frac{m_{\text{sample}} \times C_{\text{tartrate}}}{V_{\text{titrant}}}$$

C titrant	Titrant Titer (mg/mL)
m sample	Mass of Sample (g)
C tartrate	Water Content of Tartrate (156.6 mg/g)
V titrant	Volume of Titrant (mL)

5.1.9 Calculation of titer (water equivalent of the titrant) using water standards

$$C_{titrant} = \frac{m_{sample} \times C_{std} \times d_{std}}{V_{titrant}}$$

C titrant	Titrant Titer (mg/mL)
m sample	Mass of Sample (g)
C standard	Water Content of Standard (mg/g)
V titrant	Volume of Titrant (mL)

5.2 Equations Used in Titrations

The main variables used in calculating a result from a titration are the sample volume, the concentration of the titrant, and the volume of titrant required to reach the equivalence point. At the equivalence point, an equal number of equivalents of the analyte and titrant has been added.

5.2.1 Sample Calculation

By Mass

$$C_{sample} = \frac{V_{titrant} \times C_{titrant} \times Ratio \times FW_{analyte}}{m_{sample}} \times 100$$

C sample	Sample Concentration (g/100g)
V titrant	Volume of titrant
C titrant	Titrant Concentration (eq/L)
Ratio	Equivalence ratio of analyte/ titrant (mol analyte/ eq titrant)
FW analyte	Formula Weight of the Analyte (g/mol)
m sample	Mass of sample (g)

By Volume

$$C_{sample} = \frac{V_{titrant} \times C_{titrant} \times Ratio \times FW_{analyte}}{V_{sample}} \times 100$$

C sample	Sample Concentration (g/100mL)
V titrant	Volume of titrant
C titrant	Titrant Concentration (eq/L)
Ratio	Equivalence ratio of analyte/ titrant (mol analyte/ eq titrant)
FW analyte	Formula Weight of the Analyte (g/mol)
V sample	Volume of Sample (mL)

5.2.2 Standardize Titrant

Titrant standardization is the second most important calculation in titrations. A primary standard is titrated in order to determine the concentration of the titrant. This is essentially a typical titration calculated in "reverse", where the concentration of the solution is known and the titrant is unknown.

TITRATION THEORY

By Mass

$$C_{\text{titrant}} = \frac{m_{\text{standard}} \times \text{Ratio}}{FW_{\text{standard}} \times V_{\text{titrant}}}$$

C titrant	Titration Concentration (N)
m standard	Mass of Standard (g)
Ratio	Equivalence ratio of titrant/standard (eq titrant/ mol standard)
FW standard	Formula Weight of the Standard (g/mol)
V titrant	Volume of Titrant (L)

By Volume

$$C_{\text{titrant}} = \frac{V_{\text{standard}} \times (1 \text{ L} / 1000 \text{ mL}) \times C_{\text{standard}}}{V_{\text{titrant}}}$$

C titrant	Concentration of titrant (N)
V standard	Volume of Standard (mL)
C standard	Concentration of standard (eq/L)
V titrant	Volume of Titrant (L)

5.2.3 Blank Titration

In a blank titration a pre-titration is performed, often times on the solvent to be used for the sample titration, and the titrant volume required to reach the endpoint is noted. This blank value nullifies error due to titrant required to react with the components of the titration solution matrix. The basic titration equation can be used for a blank titration, with the single modification that the volume of titrant used in the blank titration should be subtracted from the regular titration titrant volume.

$$C_{\text{sample}} = \frac{C_{\text{titrant}} \times (V_{\text{sample}} - V_{\text{blank}}) \times \text{Ratio} \times FW_{\text{analyte}}}{m_{\text{sample}}} \times 100$$

C Sample	Sample Concentration (g/100g)
C titrant	Titration Concentration (eq/L)
V sample	Volume of Titrant required for the sample (L)
V blank	Volume of Titrant required for the blank (L)
Ratio	Equivalence ratio of analyte/ titrant (mol analyte/ eq titrant)
FW analyte	Formula Weight of the Analyte (g/mol)
m sample	Mass of sample (g)

5.2.4 Multiple End Point Titration

Some titrations have two or more endpoints, each corresponding to the equivalence point for a specific reaction. Multiple endpoint titrations are similar to a blank titration in that the volume of titrant required to reach the first endpoint is subtracted from the titrant volume used to reach the next sequential endpoint.

$$C_{\text{sample 1}} = \frac{V_{\text{titrant 1}} \times C_{\text{titrant}} \times \text{Ratio} \times FW_{\text{analyte 1}}}{m_{\text{sample}}} \times 100$$

$$C_{\text{sample 2}} = \frac{(V_{\text{titrant 2}} - V_{\text{titrant 1}}) \times C_{\text{titrant}} \times \text{Ratio} \times \text{FW}_{\text{analyte 2}}}{m_{\text{sample}}} \times 100$$

$$C_{\text{sample 3}} = \frac{(V_{\text{titrant 3}} - V_{\text{titrant 2}}) \times C_{\text{titrant}} \times \text{Ratio} \times \text{FW}_{\text{analyte 3}}}{m_{\text{sample}}} \times 100$$

C sample1	Sample 1 Concentration (g/100g)
C sample2	Sample 2 Concentration (g/100g)
C sample3	Sample 3 Concentration (g/100g)
V titrant 1	Volume of titrant required to reach the first end point (L)
V titrant 2	Volume of titrant required to reach the second end point (L)
V titrant 3	Volume of titrant required to reach the third end point (L)
C titrant	Concentration of titrant (N)
Ratio	Equivalence ratio of analyte/ titrant (mol analyte/ eq titrant)
FW analyte 1	Formula Weight of the Analyte 1 (g/mol)
FW analyte 2	Formula Weight of the Analyte 2 (g/mol)
FW analyte 3	Formula Weight of the Analyte 3 (g/mol)
m sample	Weight of Sample (mL)

5.2.5 Back Titration

The equation used in back titration calculations is also similar to the equation for a blank titration. Instead of subtracting the initial amount of titrant needed to react with the blank, the amount of second titrant needed to react with the excess titrant added in the first titration is subtracted from the amount of the first titrant added. The difference between the two amounts is the amount of titrant necessary to reach the first equivalence point.

$$C_{\text{sample}} = \frac{(C_{\text{titrant 1}} \times V_{\text{titrant 1}} - C_{\text{titrant 2}} \times V_{\text{titrant 2}}) \times \text{Ratio} \times \text{FW}_{\text{analyte}}}{V_{\text{sample}}} \times 100$$

C sample	Sample Concentration (g/100mL)
C titrant 1	Concentration of titrant 1 (N)
V titrant 1	Volume of titrant 1 (L)
C titrant 2	Concentration of titrant 2 (N)
V titrant 2	Volume of titrant 2 (L)
Ratio	Equivalence ratio of analyte/ titrant (mol analyte/ eq titrant)
FW analyte	Formula Weight of the analyte (g/mol)
V sample	Volume of sample (mL)

TITRATION THEORY

6 GLOSSARY

Acid

A chemical species that can donate one or more protons (hydrogen ions).

Acid-Base Titration

Stoichiometric neutralization titrations, based upon the reaction that occurs between an acid and base.

Activity

A physical property corresponding to the concentration of all ions in a solution. Electrodes respond to activity.

Amperometric Titration

Titrations where the current flow between two electrodes (often a metal electrode and a reference electrode) are used to monitor the titration progress.

Analyte

The chemical species being measured in a titration.

Argentometric Titration

Titrations that use silver (nitrate) as the titrant. These titrations are typically precipitation titrations.

Automatic Titrator

An instrument designed to automatically carry out a titration. It will add the appropriate amount of titrant, determine the end-point and calculate the results.

Back Titration

A type of titration where an excess amount of titrant is added to a sample forcing a sluggish reaction to go to completion. The excess reagent is then "back" titrated with a second titrant.

Base

A chemical species that can accept one or more protons (hydrogen ions).

Biamperometric Indication

Uses a double platinum pin electrode to measure the current flow through a titration solution.

Bivoltametric Indication

Uses a double platinum pin electrode to measure the voltage required to maintain a constant current flow through a titration solution while constant voltage is applied across the platinum elements of the electrode

Burette

A graduated cylindrical piece of laboratory glassware that is used to dispense precise amounts of solution.

Complex Ion

A species where a central metal ion is covalently bonded to one or more electron donating groups called ligands.

Complexometric Titrations

Metal ions are titrated using a titrant that binds strongly to it. The titrants often contain Ethylenediaminetetraacetic Acid (EDTA) or Cyclohexylenedinitrilotetraacetic Acid (CDTA).

End point

The point where a titration is stopped because a physical change in the solution has indicated a completed titration. Titration end points typically coincide with the equivalence point. A fixed value end point (pH or mV), can be used as well. The titration will stop at the desired point regardless if the titration is complete.

Equivalence point

The point where the quantity of titrant is stoichiometrically equal to the quantity of analyte.

Formal

The theoretical number of equivalents per liter of the solution. It is used in solutions where the exact concentration of a species may be affected by the other ions present, therefore the stated concentration may not be exactly correct.

Gravimetric Analysis

A quantitative determination of an analyte based on the mass of the solid.

Indicator Electrode

An electrode that responds to the species of interest. The electrode potential is proportional to the concentration or activity of that ion in the solution being measured.

Indicators

Chemical indicators are typically organic dyes that change form under different physical conditions, causing a color change that can be seen by an analyst. Typically used in manual titrations. Chemical indicators have been replaced with electrometric indicators, which are used with automatic titrators.

Inflection Point

The point on a titration curve where the second derivative curve changes signs.

Ion Selective Electrode (ISE)

An electrode that responds to a specific ion, the electrode potential is proportional to the concentration or activity of that ion in the solution being measured.

Karl Fischer Titration

A titration that uses a chemical reaction that is specific for determining water.

Manual Titration

A titration that is carried out by hand, the analyst must add the appropriate amount of titrant, determine the end point and calculate the results.

Molar

The concentration of a solute in a solution.

Mole (mol)

A quantity of a chemical species. The molecular weight of a substance in grams is equal to the mass of one mole of the substance. One mole is equal to 6.022×10^{23} atoms or molecules.

Monochromator

A device that allows only a narrow range of wavelengths to pass through it by separating the light into different wavelengths.

Multiple End Point Titration

A titration that reacts multiple species in solution sequentially using the same titrant. The concentration of each analyte can be determined from their respective end points.

Nernst Equation

The fundamental equation relating cell voltage to the concentration of a solution.

TITRATION THEORY

Neutralization

A chemical reaction where an acid and a base react to form a neutral salt and water.

Non-aqueous

A solution that does not contain water.

Non-aqueous Titration

A titration that is performed in non-aqueous solutions. Typically used to titrate very weak acid and bases to eliminate the leveling effect water has on all acids and bases dissolved in it.

Normal

The concentration of a solution which accounts for any stoichiometric difference between the various species in a solution.

Oxidation/ Reduction Potential (ORP)

A voltage generated in a solution which is a result of the ratio of the oxidized to reduce species. Typically measured potentiometrically with an ORP sensor.

Oxidant

The species that is accepting electrons in a redox reaction.

Pipette

Scientific apparatus that is used to deliver precise volumes of liquids.

Polyprotic Acid

Acids that are capable of donating more than one proton per acid molecule

Potentiometric Titration

A titration in which the endpoint is determined by monitoring the voltage of the solution using an electrode.

Precipitation Titration

A titration in which the analyte reacts with the titrant to form an insoluble compound. The end point is typically detected with an ISE sensitive to either the analyte or titrant.

Reagent

The chemical added in a titration that causes the given reaction to occur.

Reduction-Oxidation Reaction (redox)

A chemical reaction in which the atoms involved in the reaction have their oxidation numbers changed. Reduction is the gain of electrons, which decreases the oxidation number. Oxidation is the loss of electrons, which increases the oxidation number.

Reductants

The electron donor in a redox reaction.

Reference Electrode

An electrode that supplies a constant electrode potential. It is used in combination with an "indicator" electrode, allowing for the "indicator" electrode potential to be measured.

Relative Standard Deviation (RSD)

A measure of the amount of relative variation in a set of data. It is calculated by dividing the standard deviation by the mean: $RSD = (\text{Standard Deviation of } X) * 100 / (\text{Mean of } X)$

Repeatability

The variation in sample measurements taken by a single person or instrument under the same conditions.

Spectrophotometric Titration

A titration in which the end point is marked by a change in the color and/or color intensity.

Stoichiometry

The quantitative relationship of the reactants and products in a chemical reaction.

Titrant

The chemical added in a titration that causes the given reaction to occur.

Titration

A quantitative, volumetric procedure used in analytical chemistry to determine the concentration of an analyte in solution. The concentration of the analyte is determined by slowly adding a titrant to the solution. As the titrant is added, a chemical reaction between the titrant and the analyte occurs.

Titration Curve

A graph containing the physical data obtained for a titration. The data plotted is often an independent variable (volume of titrant) vs. a dependent variable (pH of the solution). From the titration curve, the equivalence point or end point can be determined.

TITRATION THEORY

Titr THEORY 903
02/11