



PEWA
Messtechnik GmbH

Weidenweg 21
58239 Schwerte

Tel.: 02304-96109-0
Fax: 02304-96109-88
E-Mail: info@pewa.de
Homepage : www.pewa.de

FLUKE®

721

Pressure Calibrator

Users Manual

October 2013

© 2013 Fluke Corporation. All rights reserved. Specifications are subject to change without notice.

All product names are trademarks of their respective companies.

LIMITED WARRANTY AND LIMITATION OF LIABILITY

This Fluke product will be free from defects in material and workmanship for three years from the date of purchase. This warranty does not cover fuses, disposable batteries, or damage from accident, neglect, misuse, alteration, contamination, or abnormal conditions of operation or handling. Resellers are not authorized to extend any other warranty on Fluke's behalf. To obtain service during the warranty period, contact your nearest Fluke authorized service center to obtain return authorization information, then send the product to that Service Center with a description of the problem.

THIS WARRANTY IS YOUR ONLY REMEDY. NO OTHER WARRANTIES, SUCH AS FITNESS FOR A PARTICULAR PURPOSE, ARE EXPRESSED OR IMPLIED. FLUKE IS NOT LIABLE FOR ANY SPECIAL, INDIRECT, INCIDENTAL OR CONSEQUENTIAL DAMAGES OR LOSSES, ARISING FROM ANY CAUSE OR THEORY. Since some states or countries do not allow the exclusion or limitation of an implied warranty or of incidental or consequential damages, this limitation of liability may not apply to you.

Fluke Corporation
P.O. Box 9090
Everett, WA 98206-9090
U.S.A.

Fluke Europe B.V.
P.O. Box 1186
5602 BD Eindhoven
The Netherlands

Table of Contents

Title	Page
Introduction	1
Contact Fluke	1
Safety Information	2
Symbols	4
Standard Equipment.....	5
Product Features.....	5
Display.....	8
Language Selection.....	9
Home Menu Functionality.....	10
Backlight Use	10
Zero Function	10
External Sensor (Absolute).....	10
Menus	11
SWITCHTEST	11
%ERROR	14

MINMAX	17
SET UNITS	18
CONTRAST	19
Lock and Unlock Configurations (CFG)	19
AUTO OFF	20
RESOLUTION.....	21
HART	21
PROBE TYPE	22
DAMP	24
Measure Pressure	24
Media Compatibility	25
Measurements	25
Transmitter Calibration	28
mA Input Function.....	28
Pressure-to-Current Transmitter Calibration	28
Ranges and Resolution.....	30
Maintenance	31
Replace the Batteries.....	31
Clean the Product	32
User-Replaceable Parts and Accessories	33
General Specifications.....	35
Environmental	35
Electrical and Temperature Measurement (1 year).....	35
Physical	36

List of Tables

Table	Title	Page
1.	Symbols.....	4
2.	Product Features.....	7
3.	Display Functions.....	9
4.	Ranges and Resolutions.....	30
5.	User-Replaceable Parts and Accessories.....	33

List of Figures

Figure	Title	Page
1.	Product Interface	6
2.	Display.....	8
3.	Pressure Switch Connection	12
4.	Percent Error Function Connection	15
5.	Temperature Measurement with RTD Probe.....	23
6.	Measure Current	26
7.	Voltage Measurement	27
8.	Pressure-to-Current Transmitter Connections.....	29
9.	Battery Replacement.....	32
10.	User-Replaceable Parts and Accessories	34

Introduction

The 721 Pressure Calibrator (the Product) is a simple to use and versatile pressure calibrator. The two internal pressure sensors are configured with different pressure measurement ranges. One range for lower pressure (P1) and one range for higher pressure (P2). The Product features inputs for mA, switch contacts, and an RTD probe. An external pressure module option gives a wider range of pressure calibration options that include absolute and differential pressure measurement.

Safety Information

A **Warning** identifies conditions and procedures that are dangerous to the user. A **Caution** identifies conditions and procedures that can cause damage to the Product or the equipment under test.

Warning

To prevent possible electrical shock, fire, or personal injury:











- Only assemble and operate high-pressure systems if you know the correct safety procedures. High-pressure liquids and gases are hazardous and the energy from them can be released without warning.
- Read all safety information before you use the Product.
- Carefully read all instructions.
- Do not use the Product around explosive gas or vapor.
- Use the correct terminals, function, and range for measurements.
- Do not apply more than the rated voltage, between the terminals or between each terminal and earth ground.
- Do not touch voltages > 30 V ac rms, 42 V ac peak, or 60 V dc.
- Remove all probes, test leads, and accessories before the battery door is opened.
- Do not exceed the Measurement Category (CAT) rating of the lowest rated individual component of a Product, probe, or accessory.
- Do not use and disable the Product if it is damaged.
- Remove the input signals before you clean the Product.
- Use only specified replacement parts.
- Have an approved technician repair the Product.
- Use the Product only as specified, or the protection supplied by the Product can be compromised.

- **Pressure sensors can be damaged and/or personnel injury can occur due to improper application of pressure. Vacuum should not be applied to any gauge pressure sensor. The Product display shows “OL” when an inappropriate pressure is applied. If “OL” is shown on any pressure display, the pressure should be reduced or vented immediately to prevent Product damage or possible personnel injury. “OL” is shown when the pressure exceeds 110 % of the nominal range of the sensor or when a vacuum in excess of 2 PSI is applied on gauge range sensors.**
- **Push the ZERO button to zero the pressure sensor when vented to atmospheric pressure.**
- **Remove the batteries if the Product is not used for an extended period of time, or if stored in temperatures that exceed the battery manufacturer’s specifications. If the batteries are not removed, battery leakage can damage the Product.**
- **Replace the batteries when the low battery indicator shows to prevent incorrect measurements.**
- **Be sure that the battery polarity is correct to prevent battery leakage.**
- **Repair the Product before use if the battery leaks.**
- **The battery door must be closed and locked before you operate the Product.**
- **Use only specified replacement parts.**

Symbols

Symbols used on the Product or in this manual are shown in Table 1.

Table 1. Symbols

Symbol	Description	Symbol	Description
	Risk of Danger. Important information. See Manual.		Conforms to relevant North American Safety Standards.
	Hazardous voltage. Risk of electric shock.		Double Insulated
	Conforms to European Union directives.		Conforms to relevant Australian EMC standards.
	Inspected and licensed by TÜV Product Services.		Battery
	This product complies with the WEEE Directive (2002/96/EC) marking requirements. The affixed label indicates that you must not discard this electrical/electronic product in domestic household waste. Product Category: With reference to the equipment types in the WEEE Directive Annex I, this product is classed as category 9 "Monitoring and Control Instrumentation" product. Do not dispose of this product as unsorted municipal waste. Go to Fluke's website for recycling information.		Conforms to relevant South Korean EMC Standards.

Standard Equipment

Make sure that the Product shipment is complete. It must include:

- The Product
- Product Manuals CD
- Getting Started Manual
- Quick Reference Guide
- Test leads
- Carry case
- Calibration certificate

Product Features

Figure 1 and Table 2 shows the location of the buttons, pressure controls, connection ports, and electrical inputs.

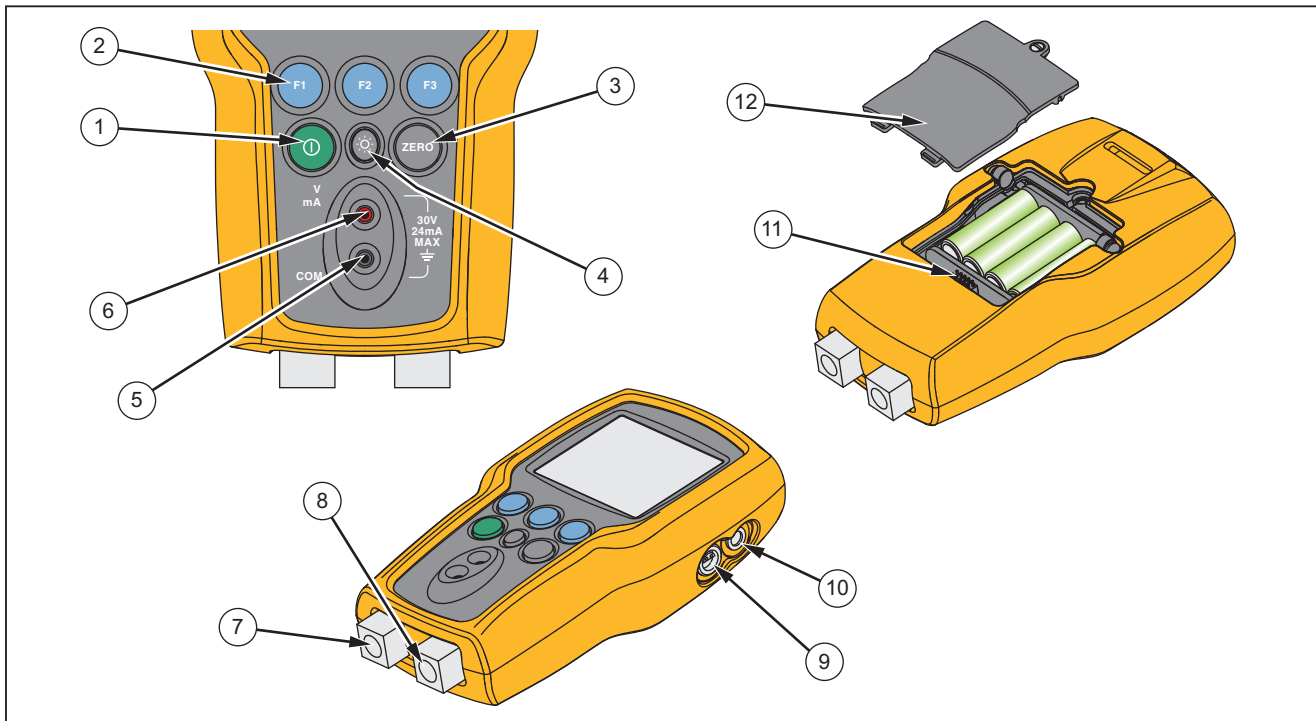

Figure 1. Product Interface

hmq001.eps

Table 2. Product Features

Item	Description
①	Power button. Turns on and off the Product
②	Function buttons. Used to configure the Product. These keys correspond to messages on the display.
③	Zero button. Zeros pressure measurements.
④	Backlight button. Push to turn the backlight on or off.
⑤	COMMON input
⑥	Input terminals to measure current, volts, and a contact closer for switch test.
⑦	Low pressure port [P1]
⑧	High pressure port [P2]
⑨	RTD probe connector
⑩	External pressure module connector
⑪	Firmware programming connector (for factory use only)
⑫	Battery door

Notes

When **Ⓢ** is pushed to turn on the Product, a short startup self-check routine is run. During that routine, the display shows the current firmware revision level, auto-shutdown status, and the range of the internal pressure sensors.

A maximum of 5 minutes warm-up is necessary for the product to reach rated accuracy. A longer warm-up period can be necessary for large changes in ambient temperature. See the “Zero Function Use” section for more about zeroing the pressure sensor displays. It is recommended that pressure ranges be zeroed each time the Product is started.

Display

The display has two main regions:

- The menu bar (located at the bottom of the screen) is used with the function buttons to access the Product menu.
- The main display has a maximum of three process measurement sub-regions.

These sub-regions will be referred to as the UPPER, MIDDLE and LOWER displays. Figure 2 shows the location of the different display fields. Table 3 describes them.

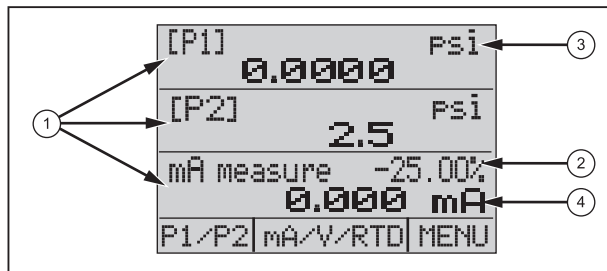

hmq007.eps

Figure 2. Display

Table 3. Display Functions

Item Number	Name	Description
①	Primary Parameters	Shows what is being measured.
②	Span Indicator	Shows the percent of the 4 mA to 20 mA span. (For mA functions only.)
③	Pressure Units	Shows one of 17 pressure units available for display.
④	Units	Shows the unit of measure for the display.

Language Selection

The user interface is available in three languages:

- English
- Norwegian
- German

To select a language:

1. Turn the Product off.
2. Hold down **F1**, **⊖**, and **Ⓜ** simultaneously.
3. As the Product powers up, the display shows the language in the top left corner of the display. Repeat the procedure to show each subsequent language. Once the necessary language is shown, the Product user interface stays in that language until another language is chosen.

Home Menu Functionality

There are three options for the Home Menu:

- P1/P2
- mA/V/RTD
- MENU

These options are shown across the bottom of the display.

From anywhere within the menu structure, push **F3** to get back to the Home Menu.

Backlight Use

Push **F4** to toggle on and off the backlight. This function cannot be controlled by the serial interface.

Zero Function

In pressure mode and when the pressure is within the zero limit, The Product zeros pressure on any port that is currently shown on the display. The zero limits are within 10 % of the full-scale range of the selected sensor. If the display shows "OL," the zero function will not operate.

External Sensor (Absolute)

If the active display shows a selected absolute module, and **ZERO** is pushed, push **F2** (SET) and you are prompted to set or default the pressure reference. This is done with **F2** and **F3** (the up and down arrows). The sensor port must be open (vented) to atmosphere while this procedure is done. Push **F1** (SET REF DONE) when zero adjust is complete.

Menus

There are 11 sub menus that can be accessed from **F3** (Main Menu). Push **F2** to go to the next menu selection. For the last menu, push **F3** (DONE) to return to the Main Menu.

The 11 sub-main menus are:

- SWITCHTEST
- %ERROR
- MINMAX
- SET UNITS
- CONTRAST
- LOCK CFG
- AUTO OFF
- RESOLUTION
- HART
- PROBE TYPE
- DAMP

Push **F1**, **F2**, or **F3**, depending on the menu, to toggle through each parameter of an active menu. The individual menus are explained in the subsequent sections.

SWITCHTEST

To access the SWITCHTEST menu, push **F3**. **SWITCHTEST** is shown on the menu bar.

Connect a pressure switch to the Product as shown in Figure 3.

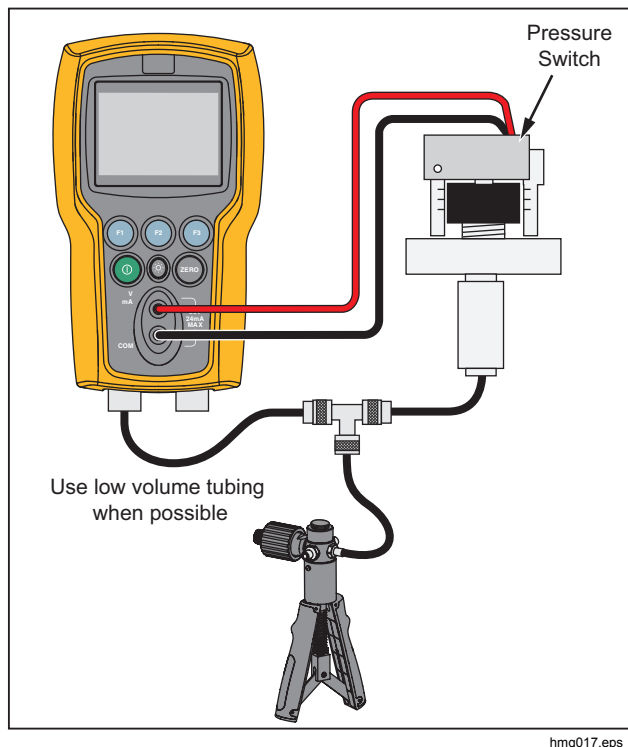

Figure 3. Pressure Switch Connection

To do a switch test:

1. Use the P1, P2, or external pressure input connections to connect the Product to the input of the switch. Connect the contact output of the switch to the COM and V mA terminals of the Product. The polarity of the terminals does not matter.
2. Connect the pump to the Product and the pressure switch.
3. Make sure the vent on the pump is open.
4. Zero the Product if necessary.
5. Close the vent after the Product is zeroed.
6. Push **F1** to select P1, P2, or EXT depending on how the Product is connected.
7. If connected to a normally closed switch, the top of the display will read "CLOSE".
8. Slowly apply pressure with the pump until the switch opens.

Note

In the SWITCHTEST mode the display update rate is increased to help capture changing pressure inputs. Even with this enhanced sample rate pressurizing, the test should be done slowly to ensure accurate readings.

9. Once the switch is open, "OPEN" will be shown. Bleed the pump slowly until the pressure switch closes.



hix043.eps



hix044.eps

10. At the top of the display it will now read, "SW OPENED AT" and show the pressure at which the switch opened.

11. Push the “NEXT” option to view when the switch closed, and the dead band.

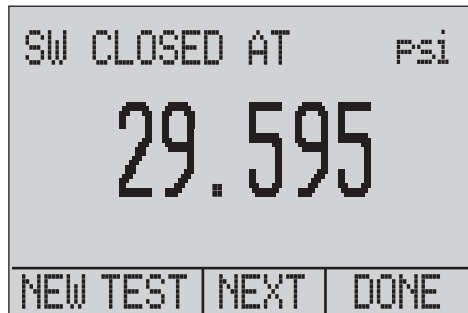

hix045.eps

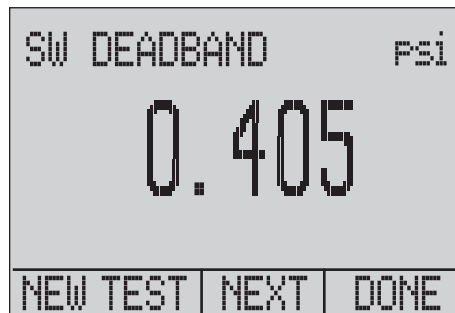

hix046.eps

12. Push the “NEW TEST” option to clear the data and do another test.
13. Push **Fn** to end the test and return to the main menu.

%ERROR

The Product features a unique function which can calculate pressure vs. milliamp error as a percentage of the 4 mA - 20 mA loop span. The %ERROR mode uses all three screens and has a unique menu structure. It simultaneously shows pressure, mA, and percent error. See Figure 4.

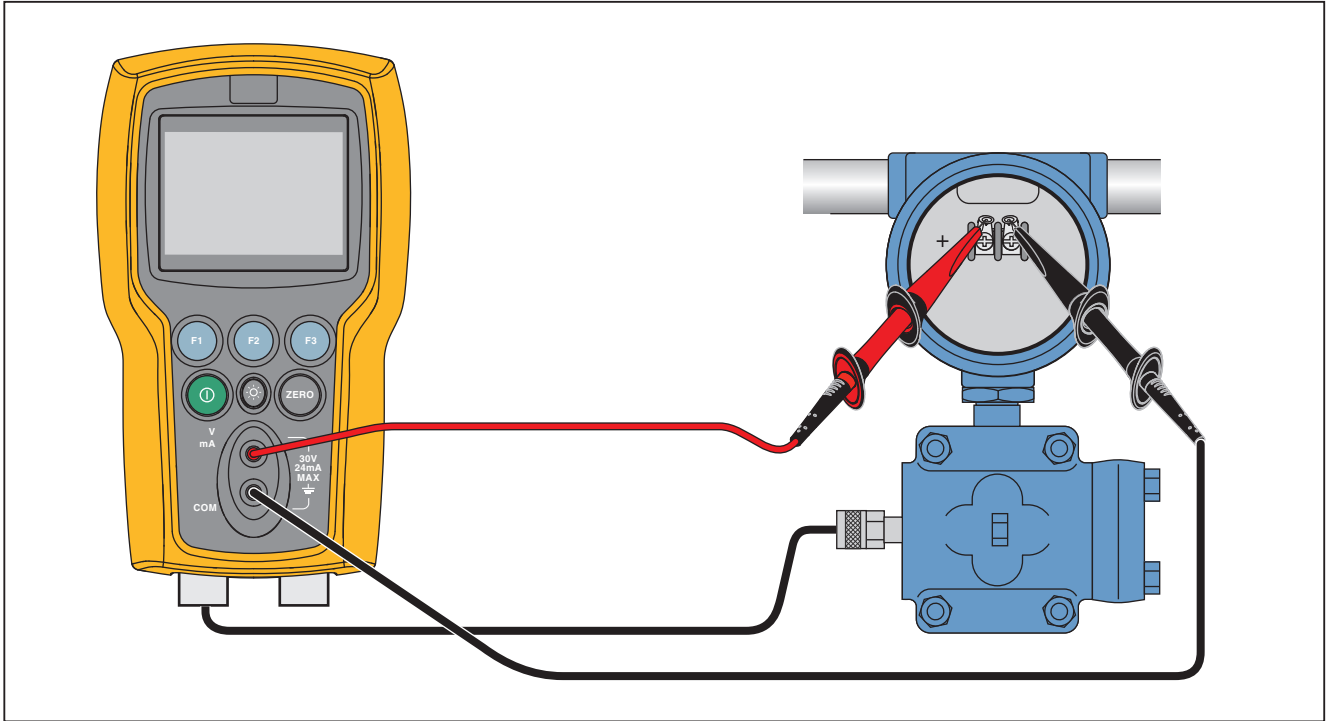

hmq019.eps

Figure 4. Percent Error Function Connection

Example:

A pressure transmitter under test is 30 psi (2 Bar) Full-Scale and outputs a corresponding 4 mA to 20 mA signal. Program a 0 psi to 30 psi pressure span into the Product and the Product calculates and shows the deviation or %Error from the expected 4 mA to 20 mA output. This eliminates the need for manual calculations and helps when it is difficult to set an exact pressure with an external pump.

To use the %ERROR function:

1. Push **F3** to access the menus.
2. Push **F2** to step through the menu until **%ERROR** is shown on the menu bar.
3. Push **F1** to open the %ERROR screen.
4. Push **F1** to scroll through the port choices (P1, P2, EXT).
5. If necessary, push **F2** to configure the %ERROR option and turn Loop Power on or off.
6. When finished, push **F3**.
7. Use the arrow keys to set the 100 % point of the desired pressure range, select DONE SET when finished.
8. Use the arrow keys to set 0 % point and select DONE SET when finished and the % ERROR mode will be ready to use.

Note

The 0 % and 100 % point will be saved in non-volatile memory until they are changed again by the user for the internal sensors, and external pressure modules. When an external module is used, the 0 % and 100 % are set to low and full scale of the module until the user changes it, or if it was previously saved.

[P1]	Psi
0.0000	
mA measure	-25.00%
0.000	mA
% Error	
	-25.000 %
P1/P2	CONFIG
	DONE

hmq054.eps

MINMAX

The Product has a min/max feature to capture the minimum and maximum values of any displayed parameter. To use the MINMAX menu:

1. Push **F3** to access the menus.
2. Push **F2** to step through the menu until **MINMAX** is shown on the menu bar.
3. Push **F1** to toggle the display through the min and max values that are stored in the min/max registers. These readings are live so that the new min/max values will be recorded while in this mode.

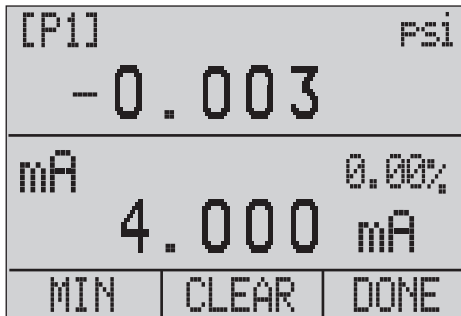

hix055.eps

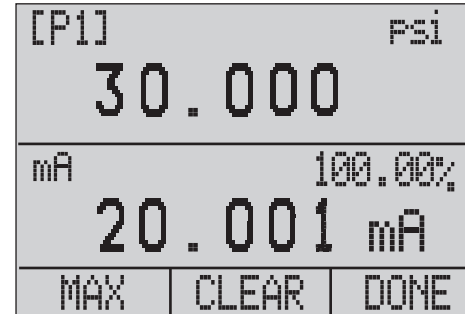

hix056.eps

To reset the min/max registers, push **F2** for “CLEAR”. These registers are also cleared at power-up or when the configuration is changed. Push **F3** to exit MIN MAX and see live measurements.

SET UNITS

Use the **SET UNITS** menu to select the measurement units for each port. To use this menu:

1. Push **F3** to access the menus.
2. Push **F2** to step through the menu until **SET UNITS** is shown on the menu bar.
3. Push **F1** to select the necessary unit. The choices are:
 - inHg 0 °C
 - mmHg 0 °C
 - kg/cm²
 - mmH₂O 4 °C
 - mmH₂O 20 °C
 - ftH₂O 60 °F
 - psi
 - inH₂O 4 °C
 - inH₂O 20 °C
 - inH₂O 60 °F
 - cmH₂O 4 °C
 - cmH₂O 20 °C
 - bar
 - mbar
 - MPa
 - kPa

4. Push **F2** to move through each port (P1, P2, or EXT) and change any necessary values.
5. Push **F3** when finished with units selection.

CONTRAST

Use the Contrast menu to adjust the display contrast.

1. Push **F3** to access the menus.
2. Push **F2** to step through the menu until **CONTRAST** is shown on the menu bar.
3. Push **F1** to access the Contrast menu.



hix024.eps

4. Push **F2** and **F3** repeatedly to adjust the display contrast to the necessary level. Push **F1** to finish the adjustment and go home as shown below.



hix025.eps

Lock and Unlock Configurations (CFG)

Use the **LOCK CFG** or **UNLOCK CFG** options of the Configuration Lock Menu (CONFIG), shown below, to lock or unlock the display configuration.



hix026.eps

When the LOCK CFG option is pushed, the menu display goes home and the menu configuration option on the Main Menu is locked. All menus are locked with the exception of:

- MINMAX
- CONTRAST
- CONFIG

You will also notice that some menu choices disappear when the LOCK CFG is used.

When the UNLOCK CFG option is selected, the configuration is unlocked and the menu display goes to the subsequent menu.

AUTO OFF

The Product can be set to automatically power off after a chosen number of minutes. This function can also be disabled. To set the auto off parameters:

1. Push **F3** to access the menus.
2. Push **F2** to step through the menu until **AUTO OFF** is shown on the menu bar.
3. Push **F1** on the Auto Off Main Menu shown below.



hix031.eps

4. Push **F2** or **F3** to select the number of minutes before the Product turns off or scroll down to 0 to disable Auto Off as shown below.



hix032.eps

5. Push **F1** to set the parameters and go to the main menu. The auto off time is reset when a key is pushed.

RESOLUTION

To choose between a low or high resolution display:

1. Push **F3** to access the menus.
2. Push **F2** to step through the menu until **RESOLUTION** is shown on the menu bar.
3. Push **F1** to select the Resolution menu.
4. Push **F1** or **F2** to turn low resolution on or off.
5. Push **F3** when finished.



hmq062.eps

HART

An internal 250 Ω HART resistor can be enabled when the Product operates in the mA Measure-24 V mode. This lets a HART Communicator be connected across the mA terminals. It is not necessary to add an external resistor.

Note

When the HART resistor is on, the maximum load-driving capacity is 750 Ω .

1. Push **F3** to access the menus.
2. Push **F2** to step through the menu until **HART** is shown on the menu bar.
3. Push **F1** to select the HART menu.
4. Push **F1** or **F2** to turn the HART Resistor on or off.
5. Push **F3** when finished.



hmq063.eps

PROBE TYPE

To select an external RTD probe for use with the Product:

1. Push **F3** to access the menus.
2. Push **F2** to step through the menu until **PROBE** is shown on the menu bar.



hix035.eps

3. Push **F1** on to select the Probe type. The probe choices are:
 - P100-385
 - P100-392
 - P100-JIS

4. Push **F1** to select the necessary probe type (see the figure below). Push **F3** to store the change and go to the Main Menu.

Note

The default probe type is PT100-385.



hix036.eps

5. Connect the RTD Probe.

The standard probe has a 10-inch insertion depth with a ¼-inch diameter stainless steel sheath. See Figure 5.

Note

The factory default type is PT100-385 so if the Product is used with the Fluke 720 RTD Probe (pn 4366669), it is not necessary to set the probe type. Connect the probe to the Product and configure the display to read temperature.

The display shows “OL” when the measured temperature is outside the nominal measurement range of the RTD function (below -40 °C or above 150 °C).

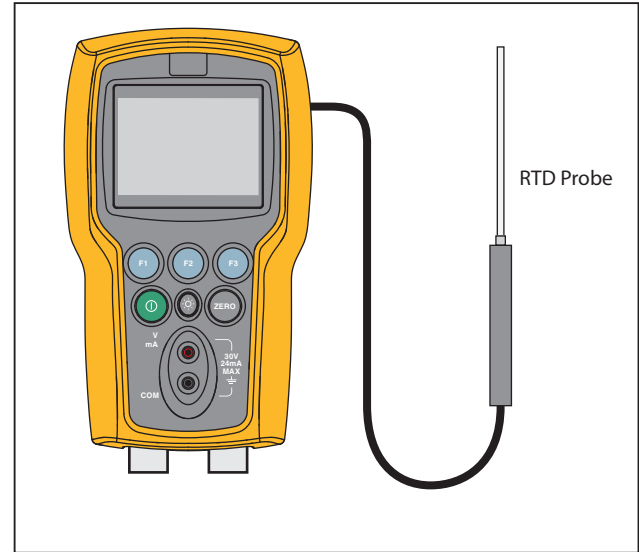

hmq016.eps

Figure 5. Temperature Measurement with RTD Probe

DAMP

Turn on or off Damping with the **DAMP** menu selection. When damping is on, the Product shows a running average from ten measurements. The Product makes approximately three indications per second.

To use the Damping function:

1. Push **F3** to access the menus.
2. Push **F2** to step through the menu until **DAMP** is shown on the menu bar.
3. Push **F1** to select the **DAMP** menu.
4. Push **F1** or **F2** to turn on or off the **DAMP** function.
5. Push **F3** when finished.



hmq064.eps

Measure Pressure

To measure pressure, connect the Product with the correct fitting and select a pressure port. The Product has two internal sensors and many optional external sensors (EPMs) are available. Make sure to choose the sensor based on working pressures and accuracy.

⚠ Warning

To prevent personal injury:

- **Pressure sensors can be damaged and/or personnel injury can occur due to improper application of pressure. Refer to Table 4 for information on overpressure and burst pressure ratings. Vacuum should not be applied to any gauge pressure sensor. The Product display shows “OL” when an inappropriate pressure is applied. If “OL” is shown on any pressure display, the pressure should be reduced or vented immediately to prevent Product damage or possible personnel injury. “OL” is shown when the pressure exceeds 110 % of the nominal range of the sensor or when a vacuum in excess of 2 PSI is applied on gauge range sensors.**

- Push  to zero the pressure sensor when vented to atmospheric pressure.

Note

To ensure accuracy of the Product, the Product must be zeroed before a device is calibrated. See the “Zero Function Use” section.

Media Compatibility

The Product has a media-isolated sensor to prevent sensor contamination. Whenever possible, clean dry air is the media of choice. If this is not possible, make sure the media is compatible with Nickel Plated Brass and 316 Stainless Steel.

Measurements

Use the input terminals on the front of the Product to measure current and volts. Current is measured in mA and percentage of range. The range on the Product is set at 0 % at 4 mA and 100 % at 20 mA.

Use the RTD connector and an RTD probe to measure temperature.

From the main menu, push  to select mA, Volts, or RTD. This function will only work on the LOWER screen.

Note

The display shows “OL” when the measured current is more than the nominal range of current measurement (24 mA).

The display shows “OL” when the measured voltage is more than the nominal range of the voltage measurement (30 V).

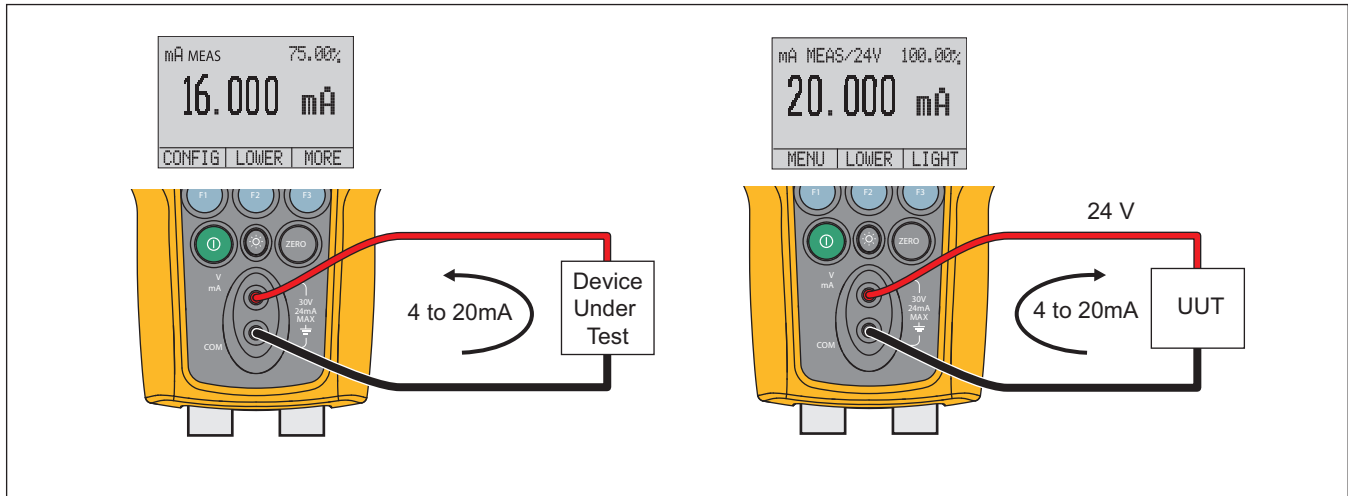

hmq011.eps

Figure 6. Measure Current

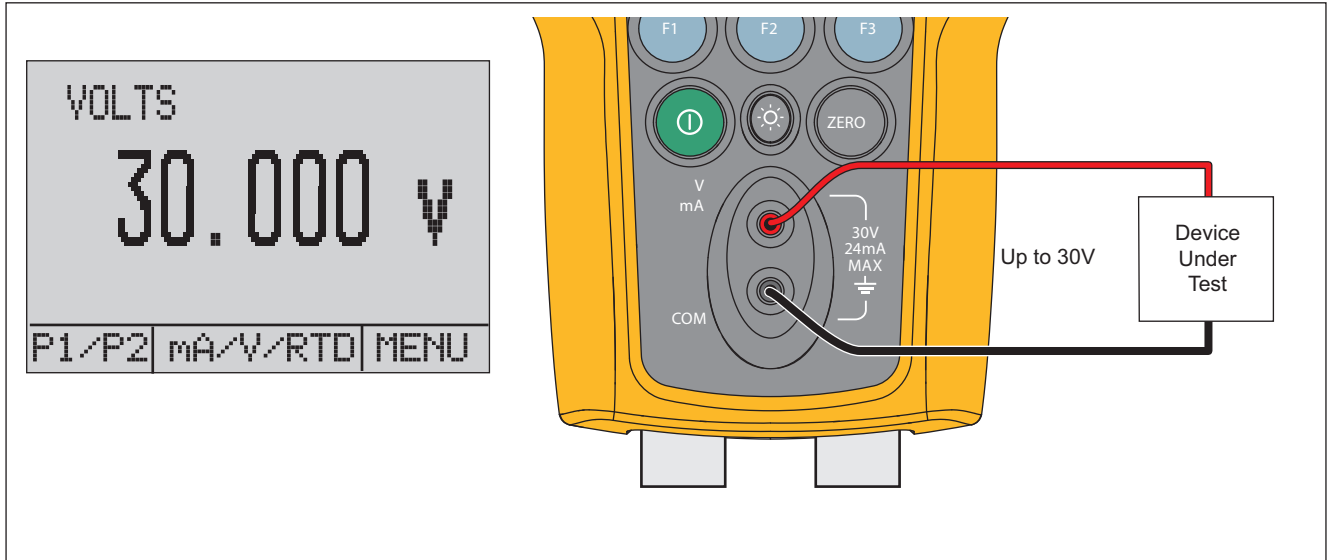

hmq015.eps

Figure 7. Voltage Measurement

Transmitter Calibration

mA Input Function

The mA input function reads back the 4 mA to 20 mA output from the device being calibrated. This can be done passively. The device under test directly generates 4 mA to 20 mA and can be read by the Product.

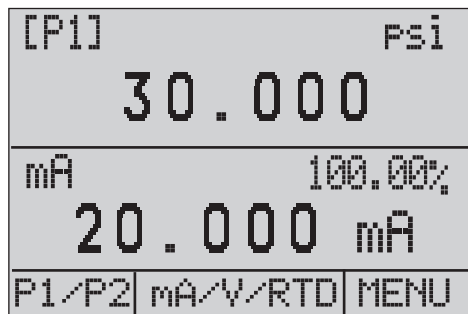

hmq047.eps

Pressure-to-Current Transmitter Calibration

To calibrate a pressure-to-current transmitter (P/I):

1. Connect the Product and the pump to the transmitter. See Figure 8.
2. Apply pressure with the pump.
3. Measure the current output of the transmitter.
4. Ensure the reading is correct. If not, adjust the transmitter as necessary.

Note

Use low-volume tubing when possible.

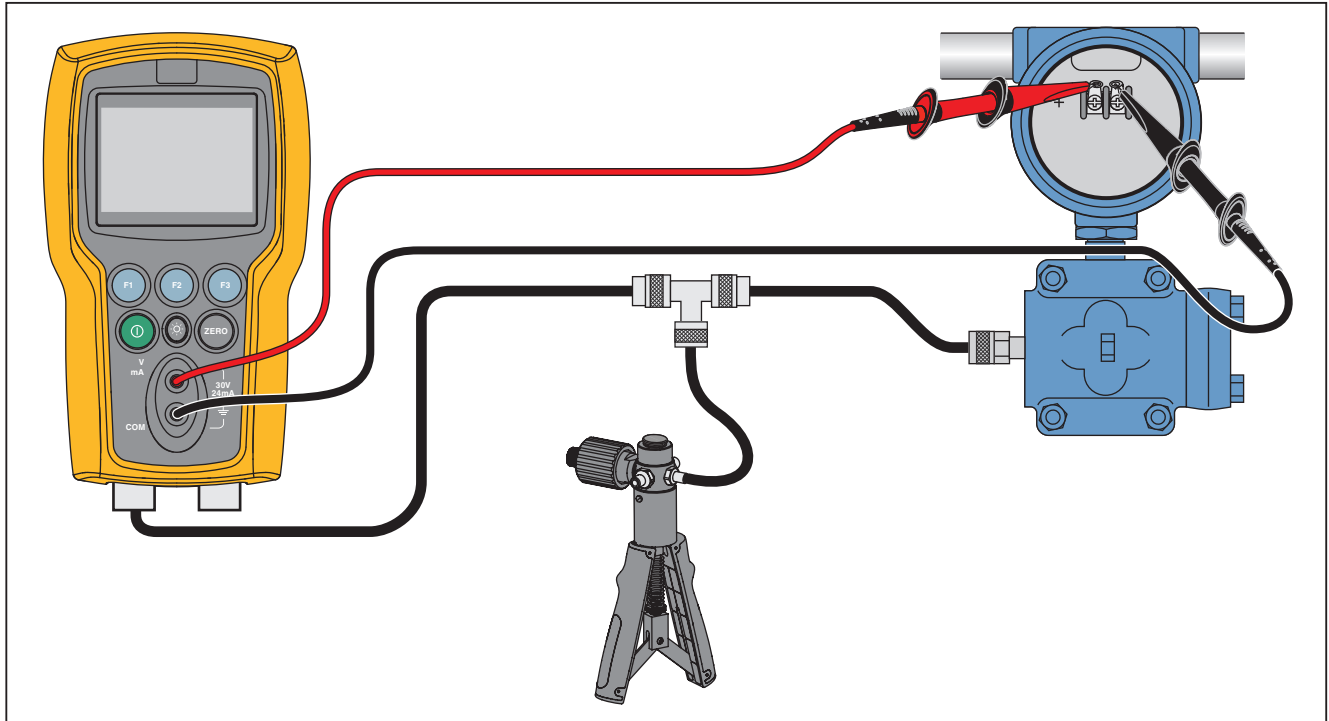

Figure 8. Pressure-to-Current Transmitter Connections

hmq018.eps

Ranges and Resolution

Ranges and resolutions for the Product are shown in Table 4.

Table 4. Ranges and Resolutions

Range (PSI)		16	36	100	300	500	1000	1500	3000	5000
Burst Pressure		60	120	400	1200	2000	4000	6000	9000	10000
Proof Pressure (PSI)		35	70	200	600	1000	2000	3000	6000	7000
Engineering Unit	Factor									
psi	1	16	36	100	300	500	1000	1500	3000	5000
bar	0.06894757	1.1032	2.4821	6.8947	20.684	34.474	68.947	103.42	206.84	344.74
mbar	68.94757	1103.2	2482.1	6894.8	20684	34474	68948	N/A	N/A	N/A
kPa	6.894757	110.32	248.21	689.48	2068.4	3447.4	6894.8	10342	20684	34474
MPa	0.00689476	0.1103	0.2482	0.6894	2.0684	3.4474	6.8948	10.342	20.684	34.474
kg/cm2	0.07030697	1.1249	2.5311	7.0307	21.092	35.153	70.307	105.46	210.92	351.53
cmH2O @ 4 °C	70.3089	1124.9	2531.1	7030.9	21093	35154	70309	N/A	N/A	N/A
cmH2O @ 20 °C	70.4336	1126.9	2535.6	7043.4	21130	35217	70434	N/A	N/A	N/A
mmH2O @ 4 °C	703.089	11249	25311	70309	N/A	N/A	N/A	N/A	N/A	N/A
mmH2O @ 20 °C	704.336	11269	25356	70434	N/A	N/A	N/A	N/A	N/A	N/A
inH2O @ 4 °C	27.68067	442.89	996.50	2768.1	8304.2	13840	27681	41521	83042	N/A
inH2O @ 20 °C	27.72977	443.68	998.27	2773.0	8318.9	13865	27730	41595	83189	N/A
inH2O @ 60 °F	27.70759	443.32	997.47	2770.8	8312.3	13854	27708	41561	83123	N/A
mmHg @ 0 °C	51.71508	827.44	1861.7	5171.5	15515	25858	51715	77573	N/A	N/A
inHg @ 0 °C	2.03602	32.576	73.297	203.60	610.81	1018.0	2036.0	3054.0	6108.1	10180

- Proof pressure - maximum allowable pressure without a shift in calibration.
- Burst pressure - sensor damaged or destroyed; some risk of personnel injury.

Maintenance

Replace the Batteries

If the batteries discharge too far, the Product automatically shuts down to prevent battery leakage.

Note

Use only AA size alkaline, Lithium batterie, or rechargeable NiMh cells.

⚠⚠ Warning

To prevent possible electrical shock, fire, or personal injury:

- **Remove the batteries if the Product is not used for an extended period of time, or if stored in temperatures above 50 °C. If the batteries are not removed, battery leakage can damage the Product.**
- **Replace the batteries when the low battery indicator shows to prevent incorrect measurements.**
- **Be sure that the battery polarity is correct to prevent battery leakage.**
- **Repair the Product before use if the battery leaks.**
- **The battery door must be closed and locked before you operate the Product.**

To change the batteries, see Figure 9:

1. Turn off the Product.
2. Turn the Product so that the display is down.
3. With a flat-head screwdriver, remove the battery door screw.
4. Replace the four AA batteries with new batteries. Make sure that the polarity on the batteries is correct.
5. Replace the battery door.
6. Tighten the battery door screw.

Clean the Product

⚠ Caution

To avoid damaging the plastic lens and case, do not use solvents or abrasive cleansers.

Clean the Product with a soft cloth dampened with water or water and mild soap.

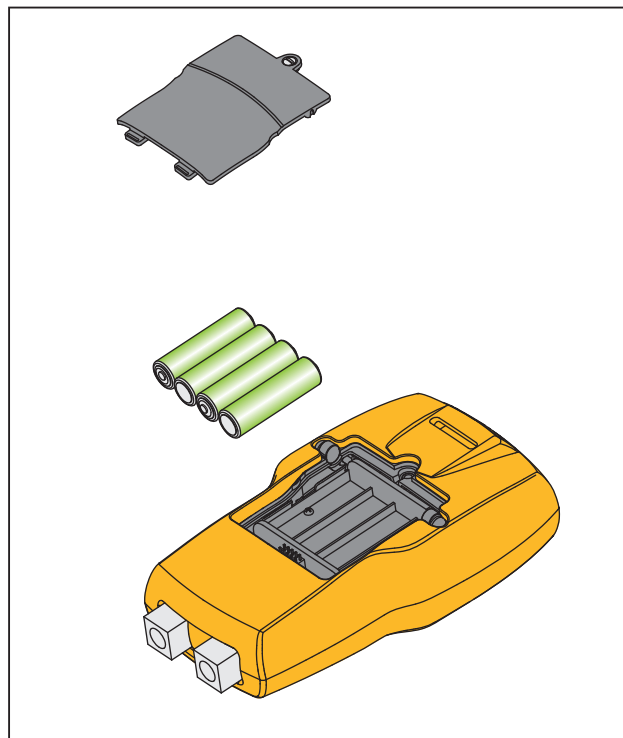

hmq061.eps

Figure 9. Battery Replacement

User-Replaceable Parts and Accessories

⚠⚠ Warning

To prevent possible electrical shock, fire, or personal injury, use only specified replacement parts.

User-replaceable parts are listed in Table 5 and shown in Figure 10 . For more information about these items, contact a Fluke representative. See the “Contact Fluke” section of this manual.

Table 5. User-Replaceable Parts and Accessories

Item	Description	Part Number
①	Yellow Holster	4364505
②	TL7X Probe Cap, Red	3986579
③	TL7X Probe Cap, Black	3986568
④	TPAK80-4-2002, Magnet Strap	669952
④	TPAK80-4-8001, Strap 9 inches	669960

Item	Description	Part Number
⑤	AA Alkaline Batteries	376756
⑥	Safety Sheet	4354619
⑦	Quick Reference Guide	4354571
⑧	Users Manual CD	4354580
Not Shown	Lens	4364743
Not Shown	Fluke-7XX-2020 Display Module	4404450
Not Shown	Keypad	4364568
Not Shown	Rubber Feet	4364579
Not Shown	Fluke-720RTD Probe for 721 and 719Pro	4366669
Not Shown	Test Lead Set	Variable ^[1]
Not Shown	Alligator Clip, Red	Variable ^[1]
Not Shown	Alligator Clip, Black	Variable ^[1]
Not Shown	Fluke-720URTD, Universal RTD Adapter (RTD Breakout Box) for 719Pro and 721	4382695

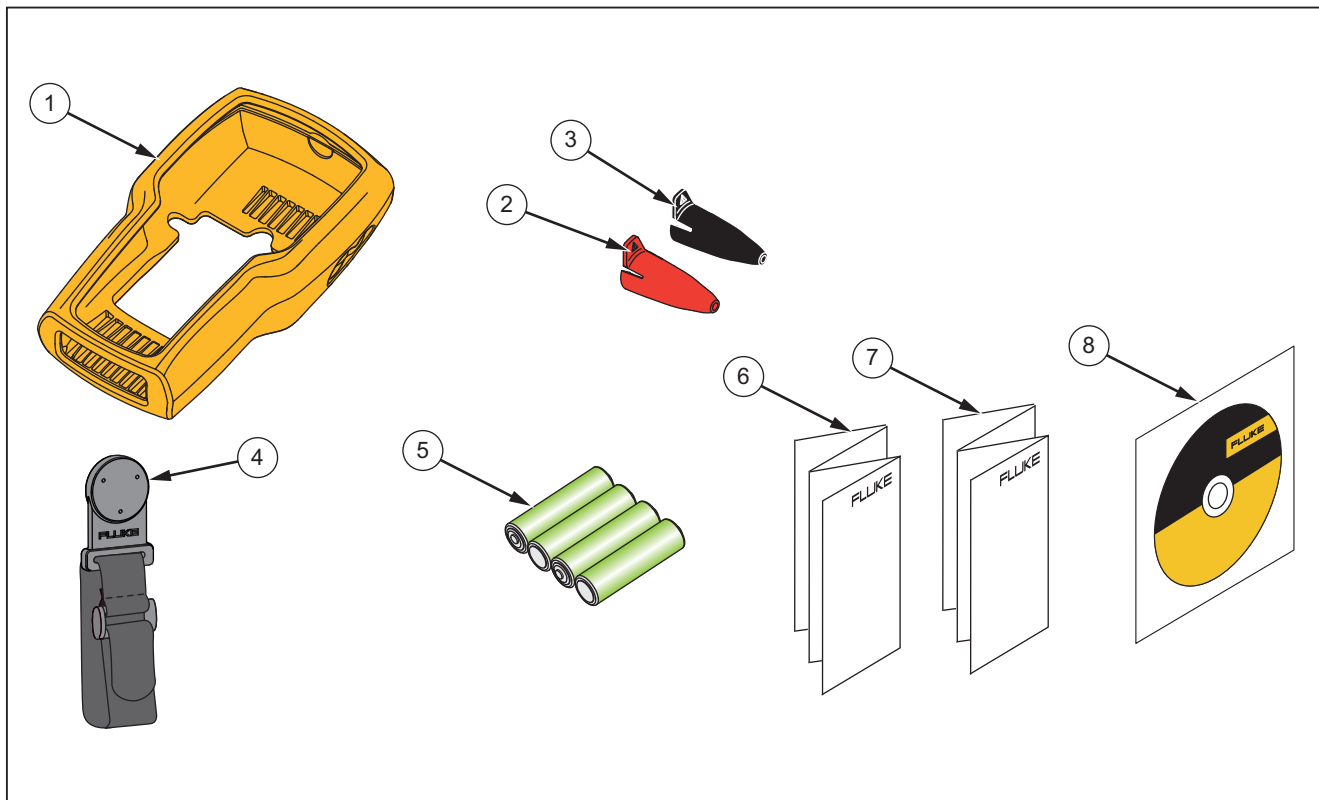

hmq065.eps

Figure 10. User-Replaceable Parts and Accessories

Specifications

(15 °C to 35 °C unless otherwise noted)

Environmental

Operating Temperature-10 °C to +50 °C (14 °F to +122 °F)

Storage

 With BatteriesPer battery manufacturer’s specification, not to exceed storage specification without batteries.

 Without Batteries-20 °C to +60 °C (-4 °F to +140 °F)

Altitude2000 m

Power Requirements6 V dc

Batteries4 AA batteries (alkaline)

Battery Life>35 hours, typical usage

Electrical and Temperature Measurement (1 year)

Function	Range	Resolution	Accuracy
mA Measure	0 to 24 mA	0.001 mA	±0.015 % of rdg ±0.002 mA
V dc Measure	0 to 30 V dc	0.001 V	±0.015 % of rdg ±0.002 V
*Temperature measure (RTD/Ohms)	-40 °C to 150 °C (-40 °F to 302 °F)	0.01 °C, 0.01 °F	±0.015 % of rdg ±0.02 Ω; ±0.1 °C (±0.2 °F) ±0.25 °C (± 0.45 °F) combined uncertainty when using 720 RTD probe accessory
Loop Power Supply	24 V	N/A	24 mA @ 24 V
*Temperature measurement requires optional 720RTD Pt-100 RTD probe available as an accessory.			

Physical

Dimensions (with holster)(H x W x D) (20 x 11 x 5.8) cm, (7.9 x 4.3 x 2.3) in

Weight (with holster)0.539 kg (1 lb 3 oz)

EMI/RFI ConformanceEN50082-1 and EN55022: Class B

Ingress ProtectionIP40

Connectors/Ports

Pressure.....Two, 1/8 in NPT, 700P Series Pressure Module

RTD.....RTD probe

Temperature Effect (all functions).....No effect on accuracy on all functions from 15 °C to 35 °C

Add ± 0.002 % F.S./°C for temps outside of 15 °C to 35 °C

**Pressure Calibrator
Specifications**

1-year Specifications		Low Pressure Sensor			High Pressure Sensor		
Model	Calibrator Description	Range Sensor 1	Resolution Sensor 1	Accuracy Sensor 1	Range Sensor 2	Resolution Sensor 2	Accuracy Sensor 2
721-1601	16 PSIG, 100 PSIG	-14 psi + 16 psi -0.97 bar to 1.1 bar	0.001 psi, 0.0001 bar	0.025 % of full scale	-12 psi to +100 psi -0.83 bar to 6.9 bar	0.01 psi 0.0001 bar	0.025 % of full scale
721-1603	16 PSIG, 300 PSIG				-12 psi to +300 psi -0.83 bar to 20 bar	0.01 psi 0.001 bar	
721-1605	16 PSIG, 500 PSIG				-12 psi to +500 psi -0.83 bar to 34.5 bar	0.01 psi 0.001 bar	
721-1610	16 PSIG, 1000 PSIG				0 psi to +1000 psi 0.00 bar to 69 bar	0.1 psi 0.001 bar	
721-1615	16 PSIG, 1500 PSIG				0 psi to +1500 psi 0.00 bar to 103.4 bar	0.1 psi 0.001 bar	
721-1630	16 PSIG, 3000 PSIG				0 psi to +3000 psi 0.00 bar to 200 bar	0.1 psi 0.01 bar	
721-1650	16 PSIG, 5000 PSIG				0 psi to +5000 psi 0.00 bar to 345 bar	0.1 psi 0.01 bar	0.035 % of full scale

1-year Specifications		Low Pressure Sensor			High Pressure Sensor		
Model	Calibrator Description	Range Sensor 1	Resolution Sensor 1	Accuracy Sensor 1	Range Sensor 2	Resolution Sensor 2	Accuracy Sensor 2
721-3601	36 PSIG, 100 PSIG	-14 psi + 36 psi -0.97 bar to 2.48 bar	0.001 psi, 0.0001 bar	0.025 % of full scale	-12 psi to +100 psi -0.83 bar to 6.9 bar	0.01 psi 0.0001 bar	0.025 % of full scale
721-3603	36 PSIG, 300 PSIG				-12 psi to +300 psi -0.83 bar to 20 bar	0.01 psi 0.001 bar	
721-3605	36 PSIG, 500 PSIG				-12 psi to +500 psi -0.83 bar to 34.5 bar	0.01 psi 0.001 bar	
721-3610	36 PSIG, 1000 PSIG				0 psi to +1000 psi 0.00 bar to 69 bar	0.1 psi 0.001 bar	
721-3615	36 PSIG, 1500 PSIG				0 psi to +1500 psi 0.00 bar to 103.4 bar	0.1 psi 0.01 bar	
721-3630	36 PSIG, 3000 PSIG				0 psi to +3000 psi 0.00 bar to 200 bar	0.1 psi 0.01 bar	
721-3650	36 PSIG, 5000 PSIG				0 psi to +5000 psi 0.00 bar to 345 bar	0.1 psi 0.01 bar	0.035 % of full scale

Electromagnetic EnvironmentIEC 61326-1: Portable

Electromagnetic CompatibilityApplies to use in Korea only. Class A Equipment (Industrial Broadcasting & Communication Equipment) [1]

[1] This product meets requirements for industrial (Class A) electromagnetic wave equipment and the seller or user should take notice of it. This equipment is intended for use in business environments and is not to be used in homes.

